



This is a digital copy of a book that was preserved for generations on library shelves before it was carefully scanned by Google as part of a project to make the world's books discoverable online.

It has survived long enough for the copyright to expire and the book to enter the public domain. A public domain book is one that was never subject to copyright or whose legal copyright term has expired. Whether a book is in the public domain may vary country to country. Public domain books are our gateways to the past, representing a wealth of history, culture and knowledge that's often difficult to discover.

Marks, notations and other marginalia present in the original volume will appear in this file - a reminder of this book's long journey from the publisher to a library and finally to you.

### **Usage guidelines**

Google is proud to partner with libraries to digitize public domain materials and make them widely accessible. Public domain books belong to the public and we are merely their custodians. Nevertheless, this work is expensive, so in order to keep providing this resource, we have taken steps to prevent abuse by commercial parties, including placing technical restrictions on automated querying.

We also ask that you:

- + *Make non-commercial use of the files* We designed Google Book Search for use by individuals, and we request that you use these files for personal, non-commercial purposes.
- + *Refrain from automated querying* Do not send automated queries of any sort to Google's system: If you are conducting research on machine translation, optical character recognition or other areas where access to a large amount of text is helpful, please contact us. We encourage the use of public domain materials for these purposes and may be able to help.
- + *Maintain attribution* The Google "watermark" you see on each file is essential for informing people about this project and helping them find additional materials through Google Book Search. Please do not remove it.
- + *Keep it legal* Whatever your use, remember that you are responsible for ensuring that what you are doing is legal. Do not assume that just because we believe a book is in the public domain for users in the United States, that the work is also in the public domain for users in other countries. Whether a book is still in copyright varies from country to country, and we can't offer guidance on whether any specific use of any specific book is allowed. Please do not assume that a book's appearance in Google Book Search means it can be used in any manner anywhere in the world. Copyright infringement liability can be quite severe.

### **About Google Book Search**

Google's mission is to organize the world's information and to make it universally accessible and useful. Google Book Search helps readers discover the world's books while helping authors and publishers reach new audiences. You can search through the full text of this book on the web at <http://books.google.com/>



HARVARD UNIVERSITY



FRANCES LOEB LIBRARY  
GRADUATE SCHOOL OF DESIGN

**NOT TO BE TAKEN FROM LIBRARY**



# MAPS

OF THE

DISTRICT OF COLUMBIA

AND

CITY OF WASHINGTON,

AND

# PLATS

OF THE

SQUARES AND LOTS OF THE CITY OF WASHINGTON.

Printed by order of the House of Representatives of the United States.

WASHINGTON:  
PRINTED BY A. BOYD HAMILTON.  
1852.

8140

\*NAC

2.82

Wash

1852

**SQUARE N° 1**

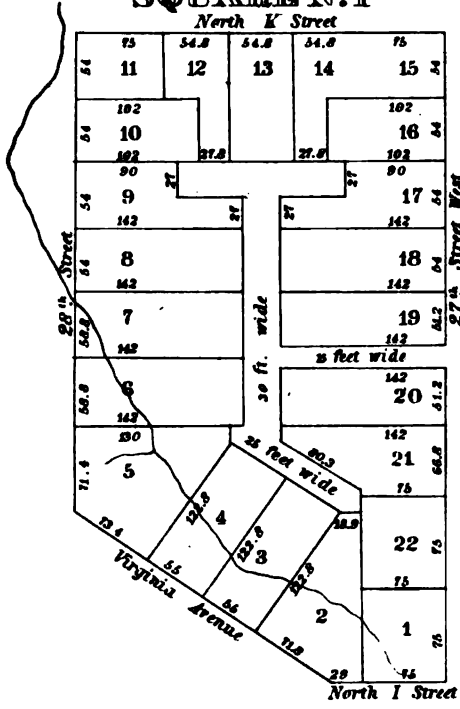

**SQUARE N° 4**

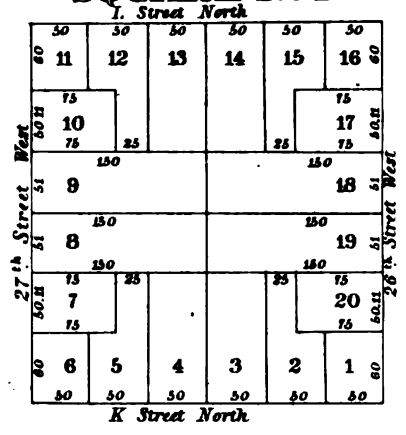

**SQUARE NORTH OF N° 4**

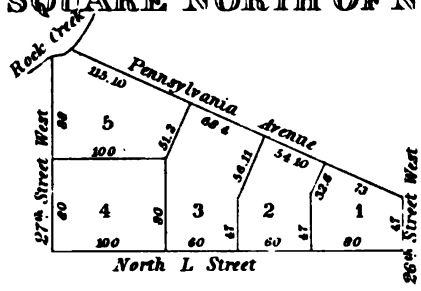

**SQUARE WEST OF N° 4**

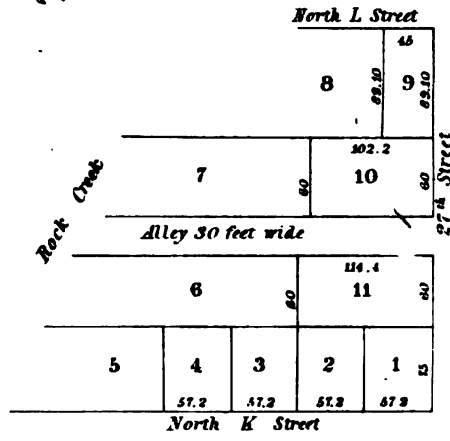

**SQUARE N° 2**

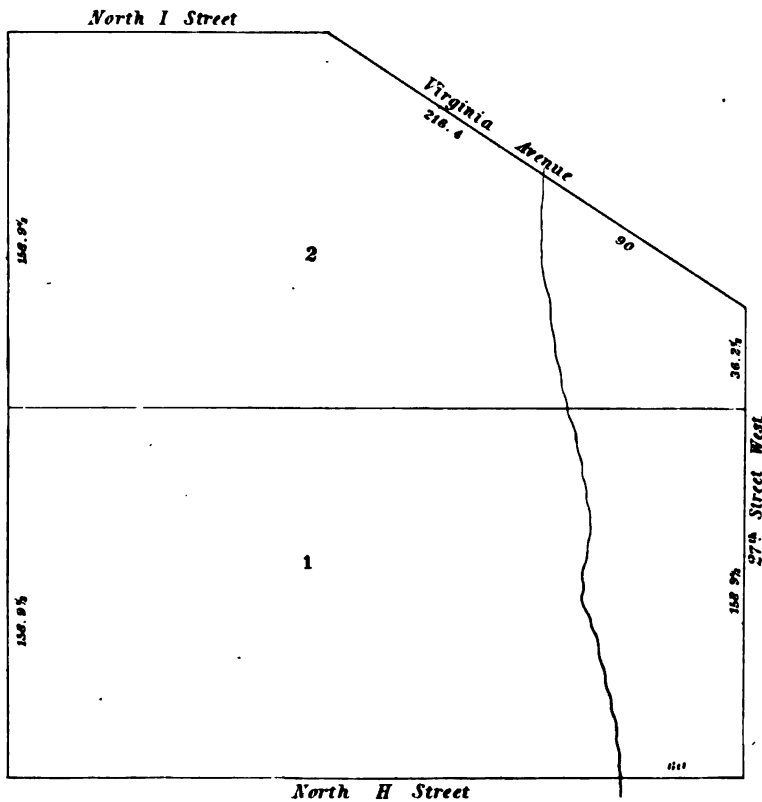





### SQUARE N°5

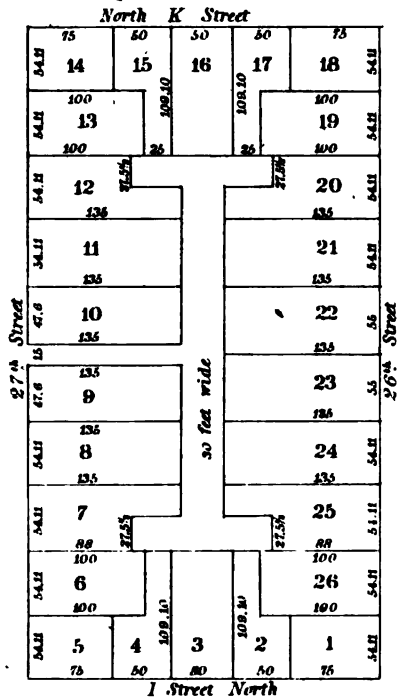

### SQUARE N°8

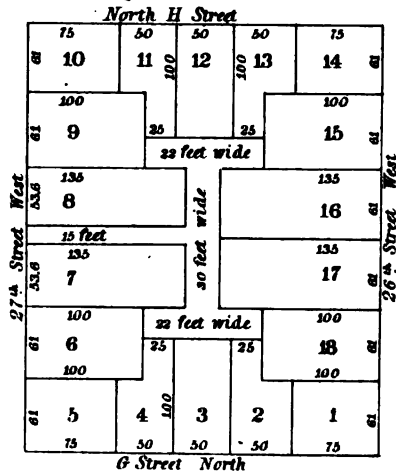

### SQUARE N°6

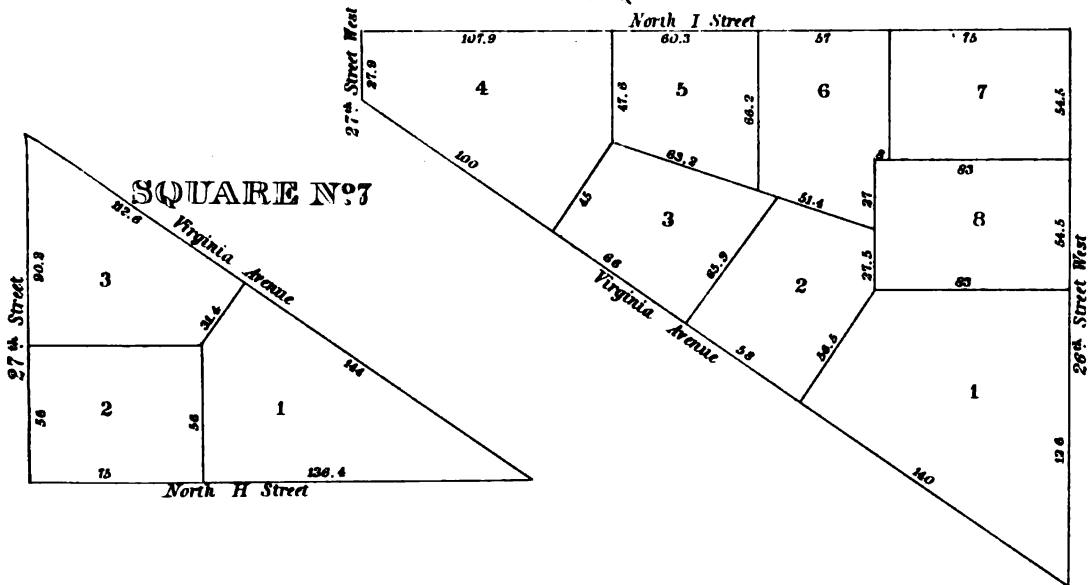

### SQUARE N°9

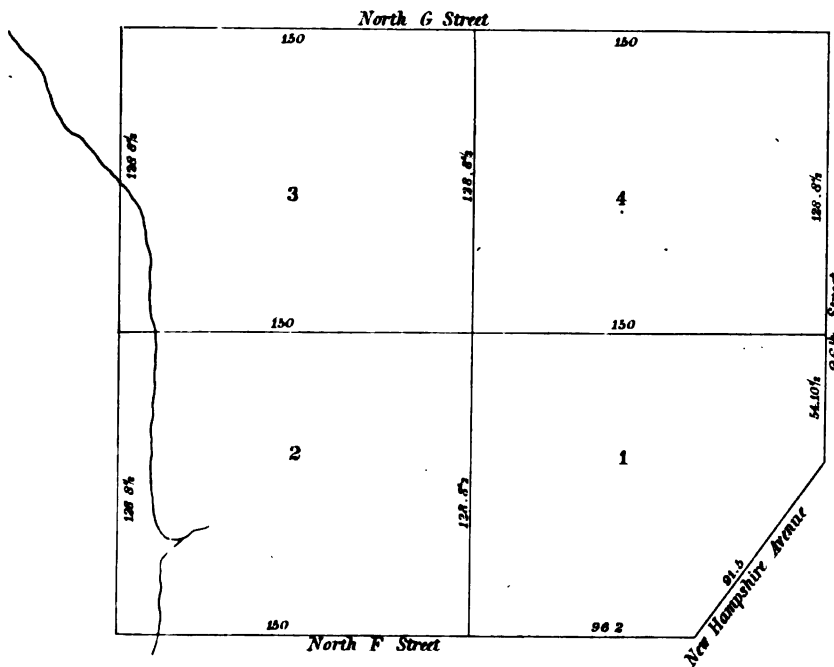



### SQUARE N°10

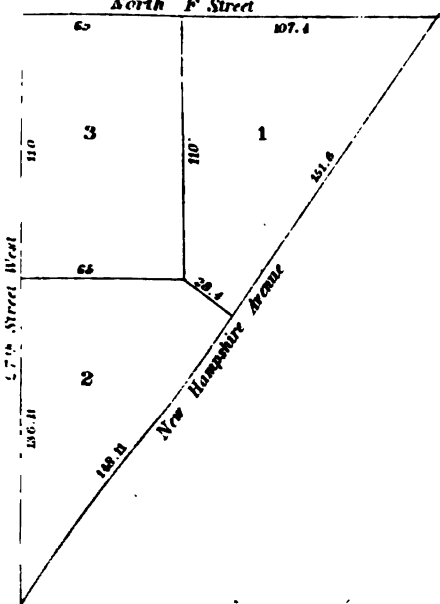

### SQUARE N°11

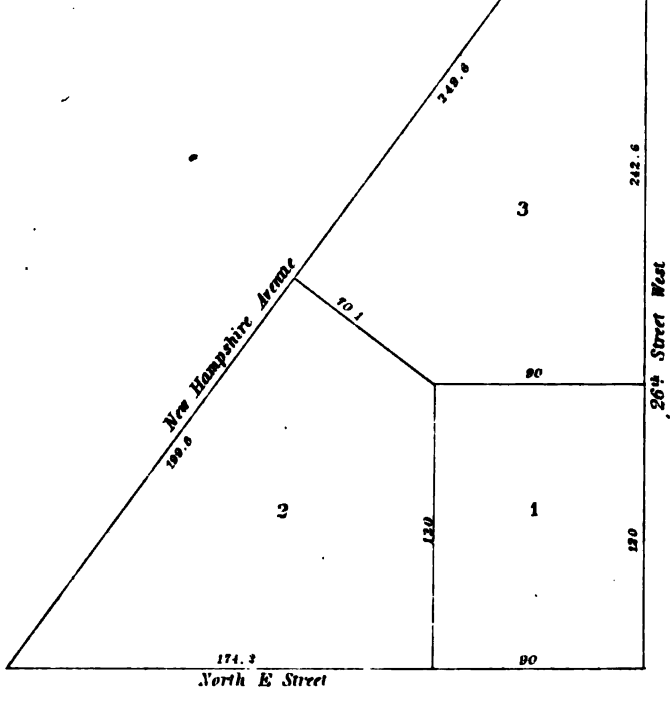

### SQUARE N°13

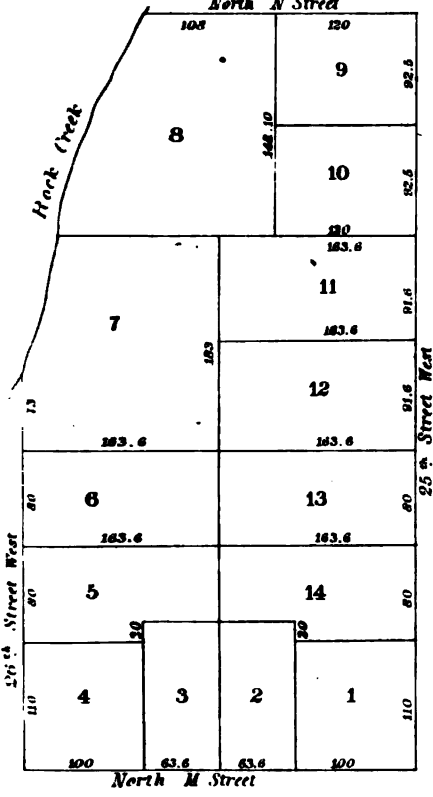

### SQUARE SOUTH OF N°12

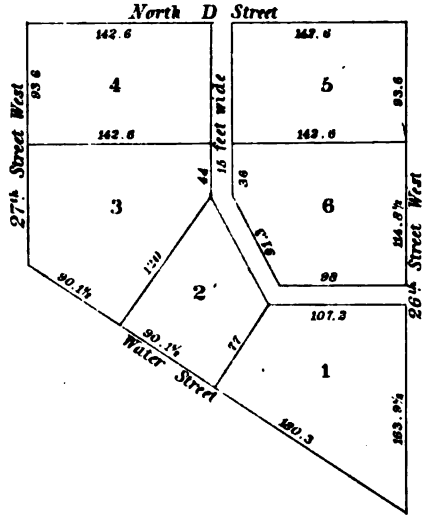

### SQUARE N°12

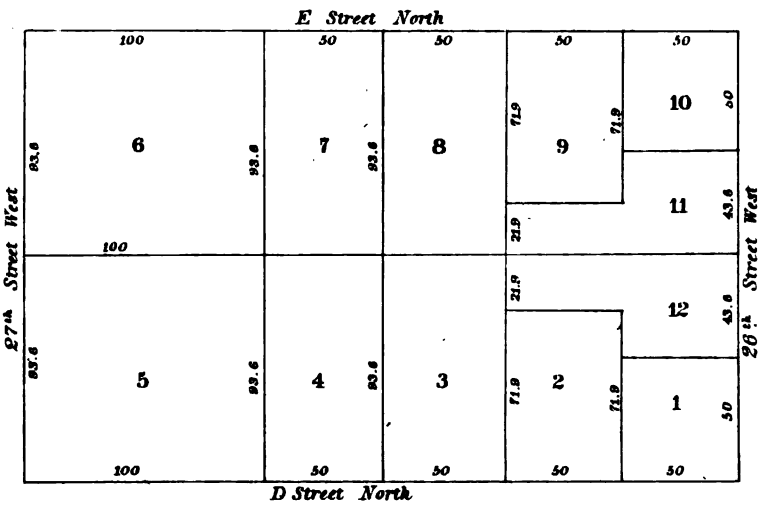



# SQUARE N° 19

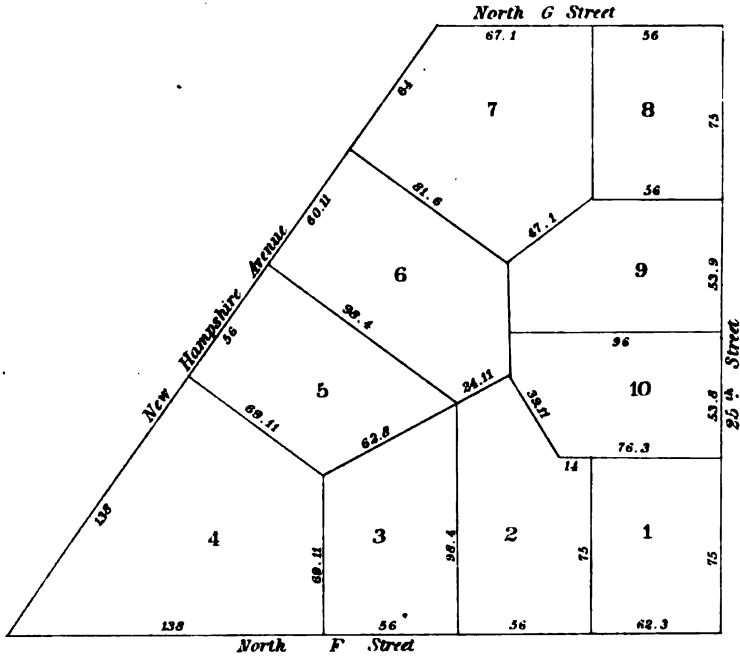

# SQUARE N° 20

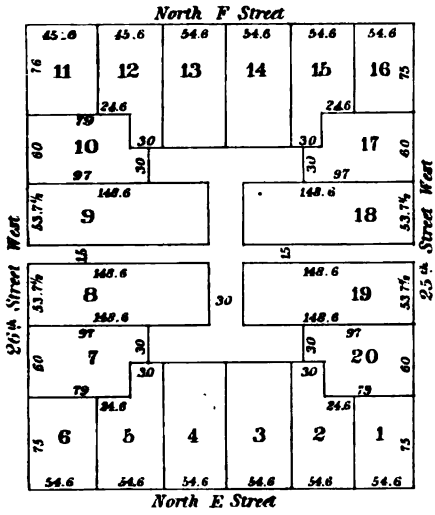

# SQUARE N° 22

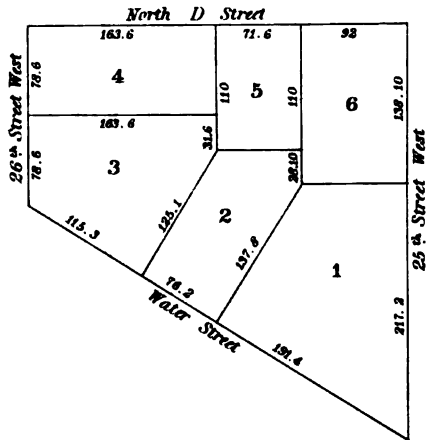

# SQUARE N° 21

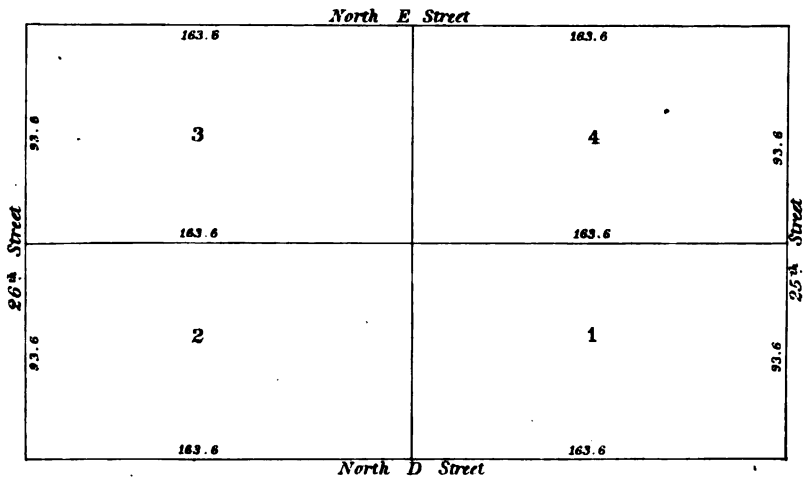



**SQUARE N°23**

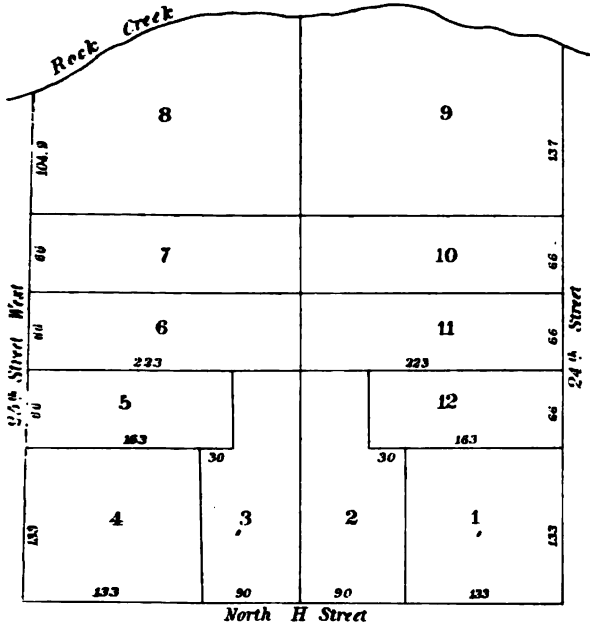

**SQUARE W. OF N°23**

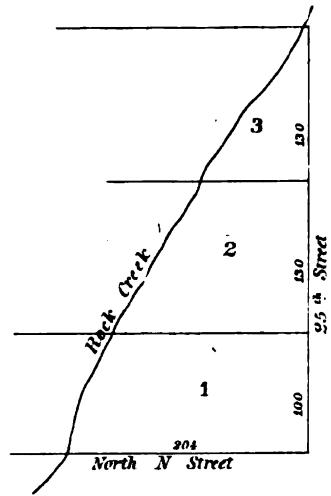

**SQUARE N°24**

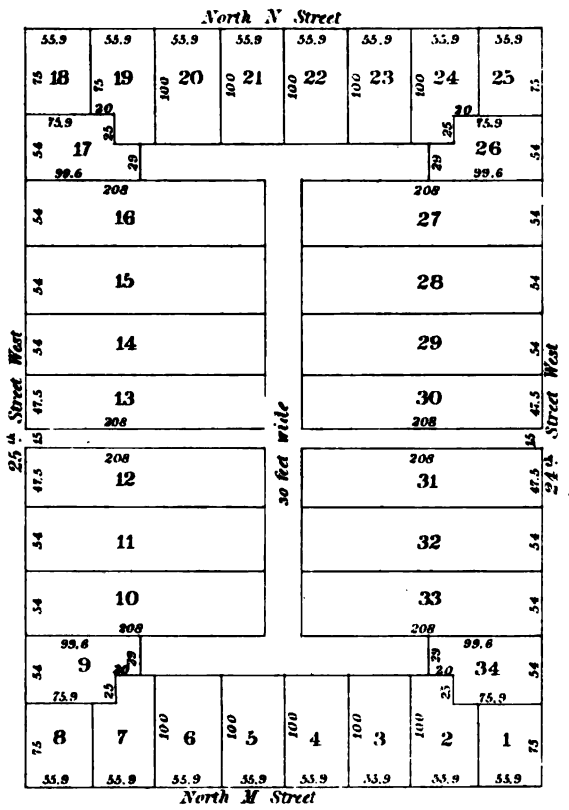

**SQUARE N°26**

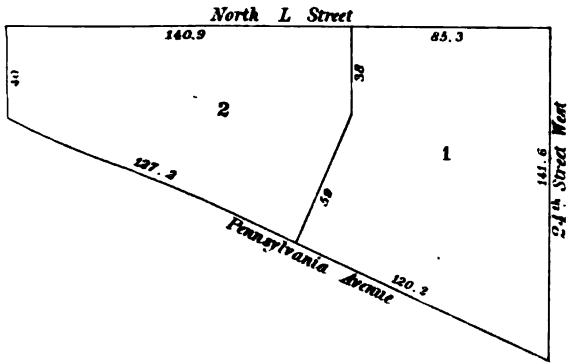

**SQUARE N°25**

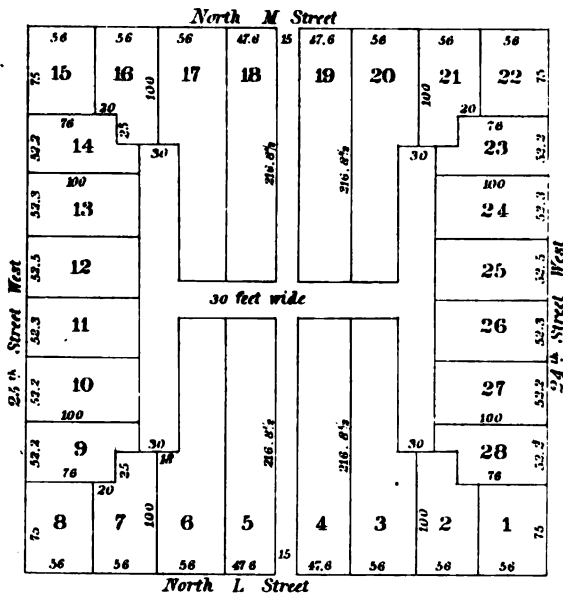





### SQUARE N°27

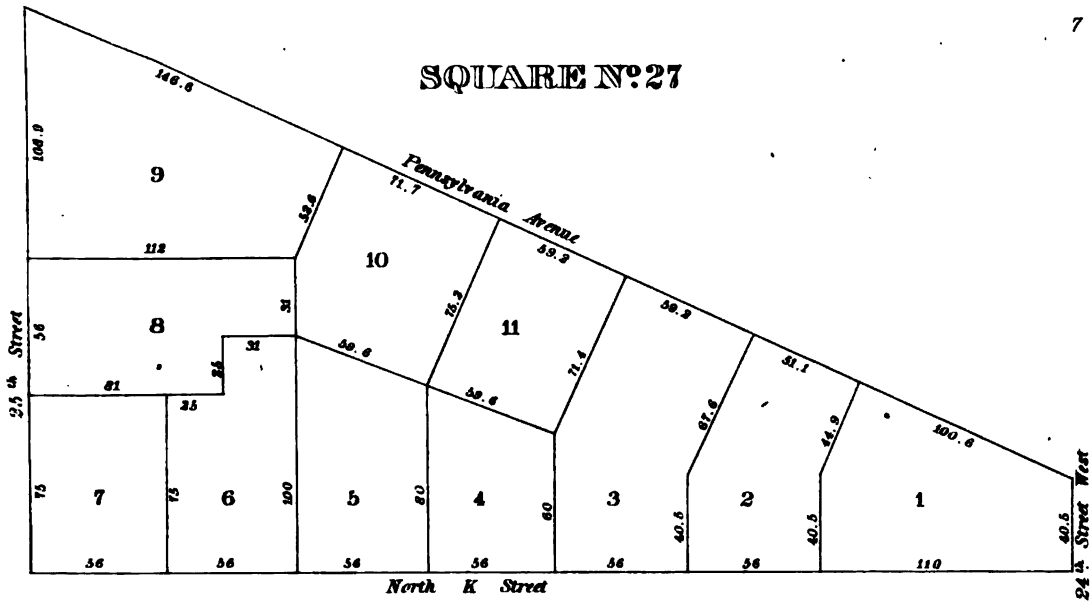

### SQUARE N°28

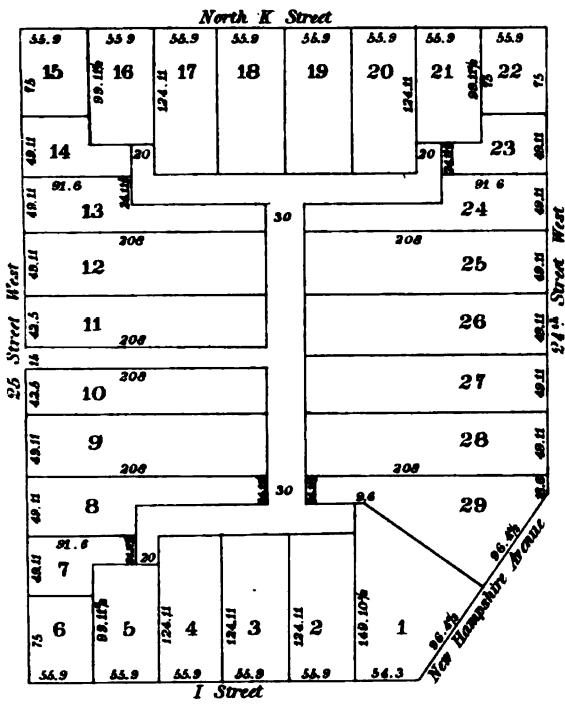

### SQUARE N°29

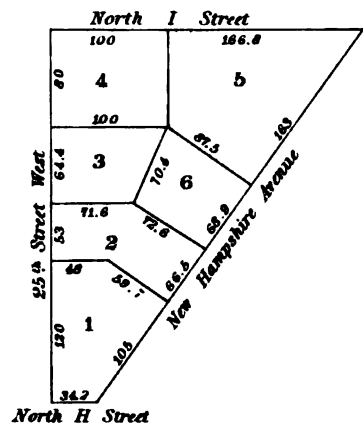

### SQUARE N°30

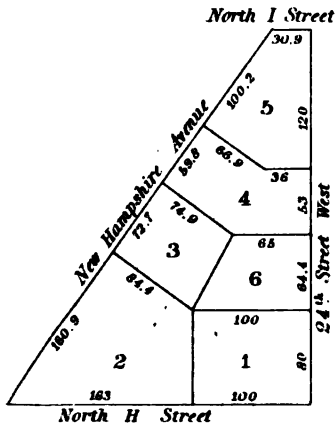

### SQUARE N°31

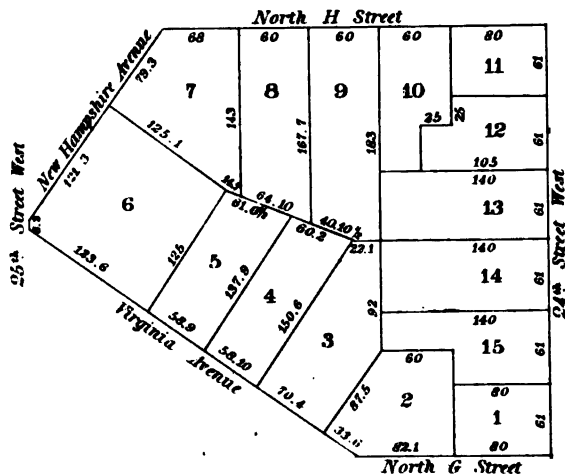



# SQUARE N°32

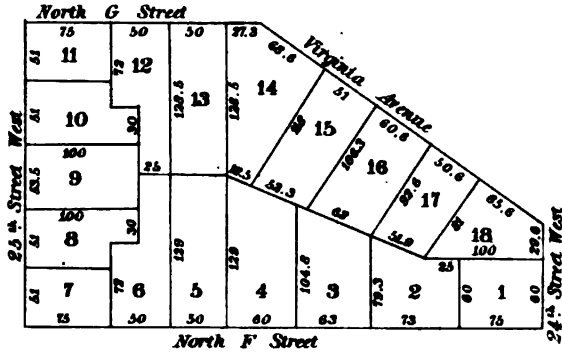

# SQUARE N°33

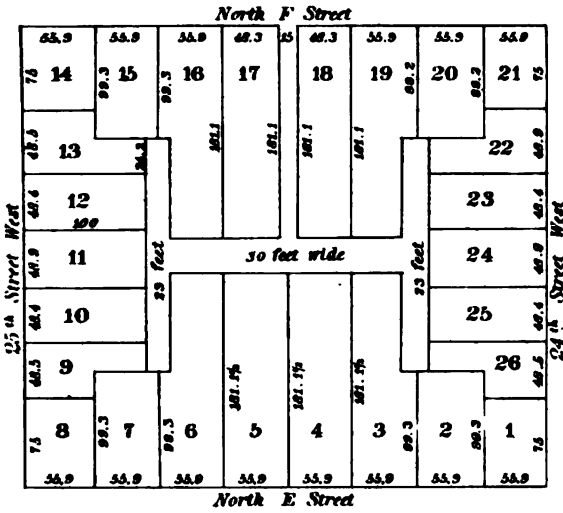

# SQUARE N°37

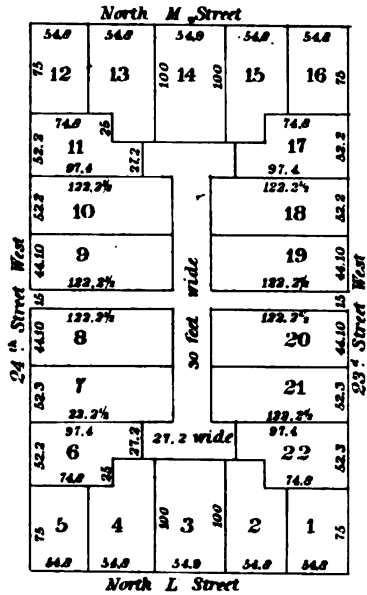

# SQUARE N°35

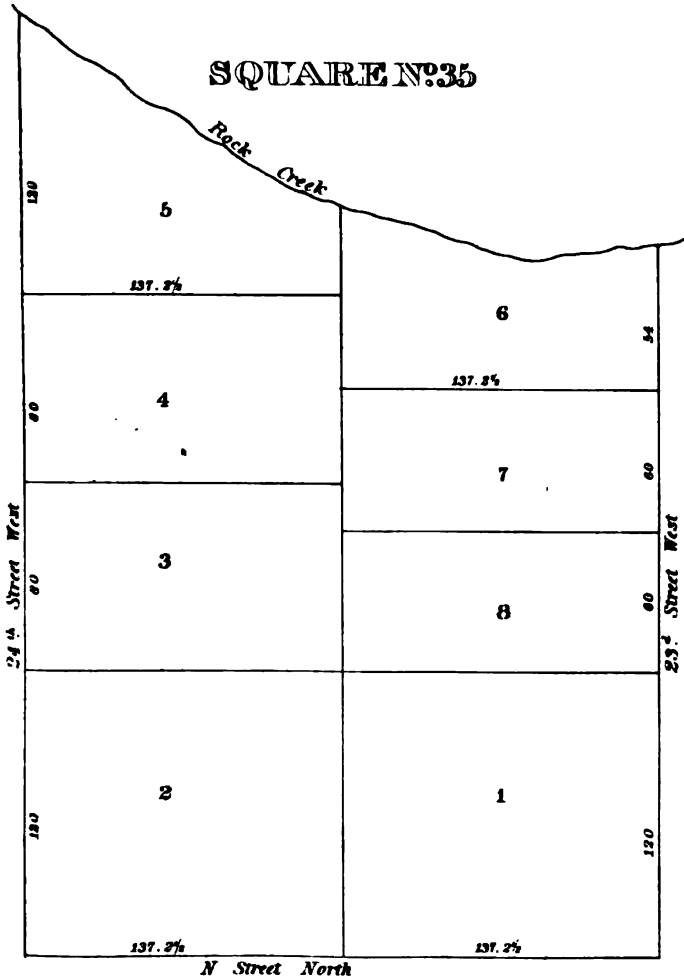

# SQUARE N°36

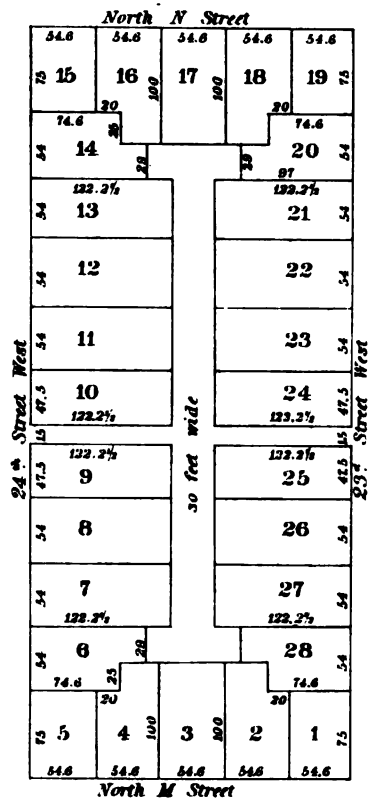



### SQUARE N°38

North L Street

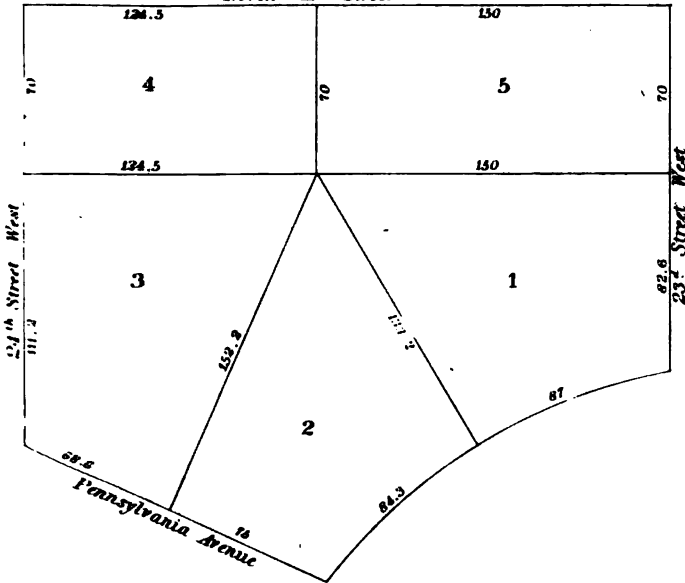

### SQUARE N°39

North K Street

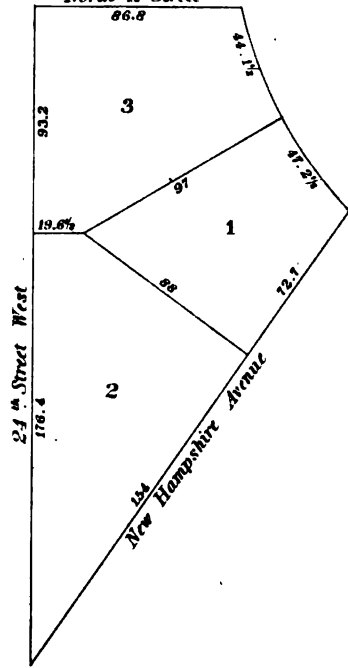

### SQUARE N°40

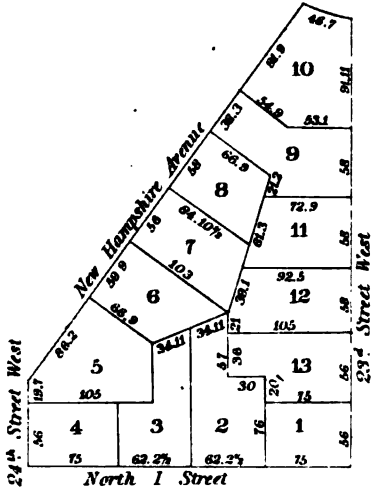

### SQUARE N°41

North I Street

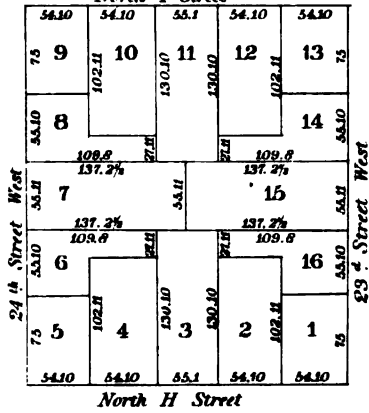

### SQUARE N°42

North H Street

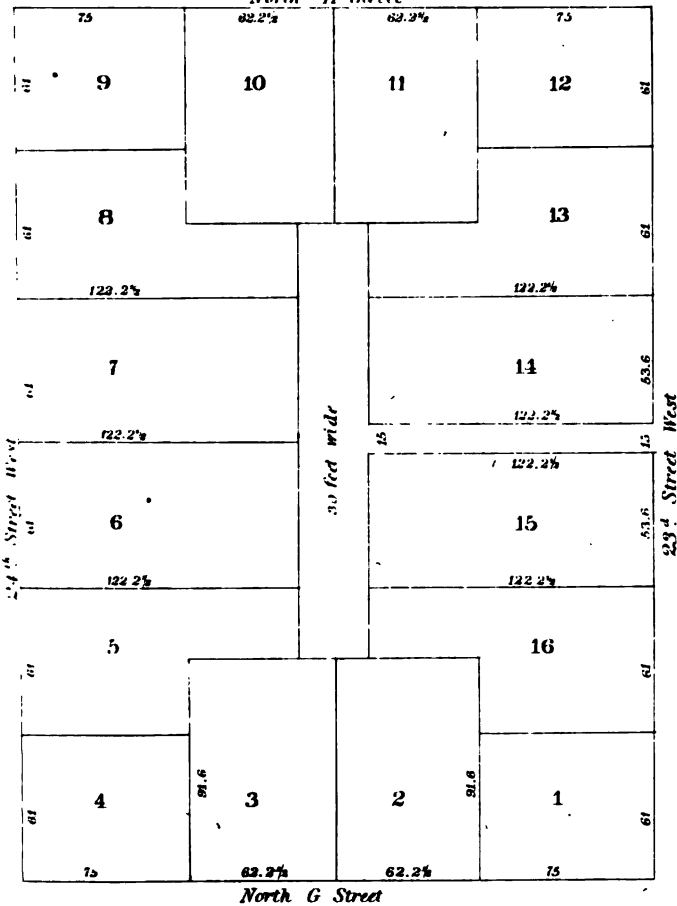

### SQUARE N°43

North G Street

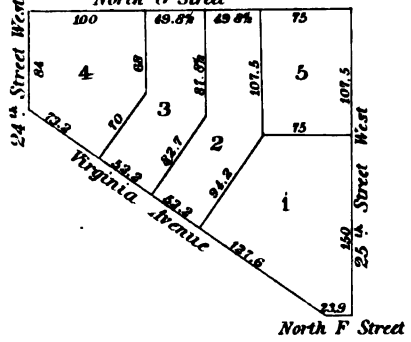

### SQUARE N°44

F Street North

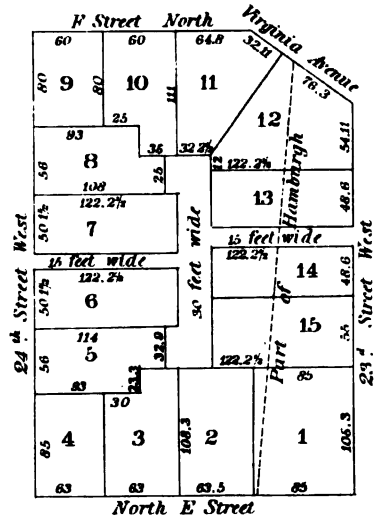



**SQUARE N°48**

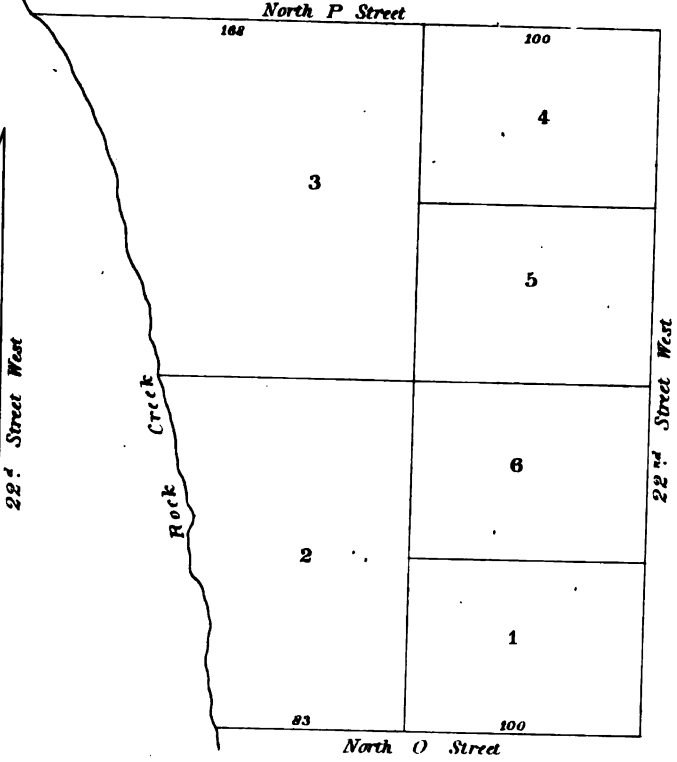

**SQUARE N°47**

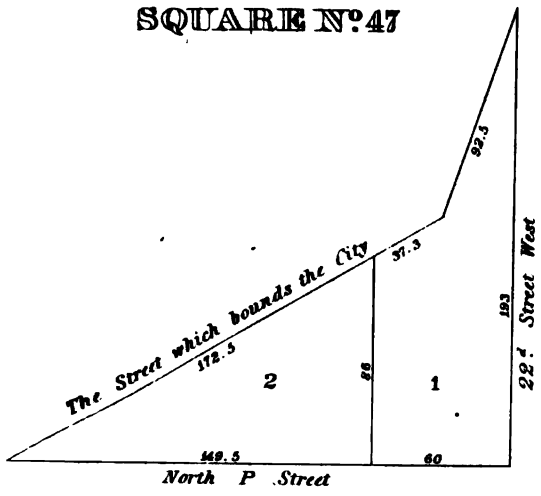

**SQUARE N°49**

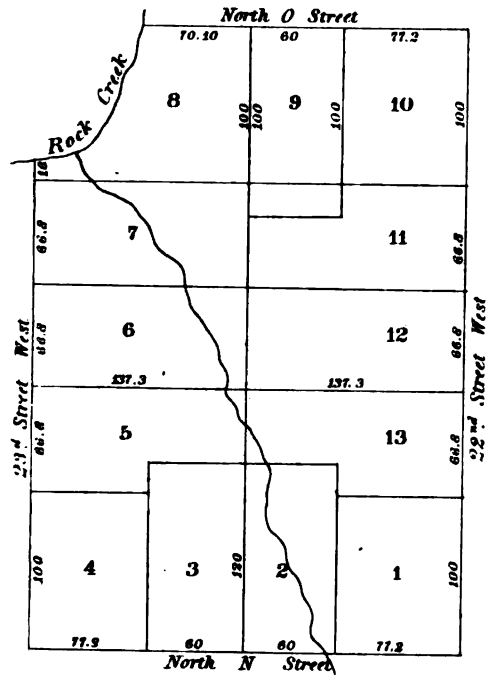

**SQUARE N°50**

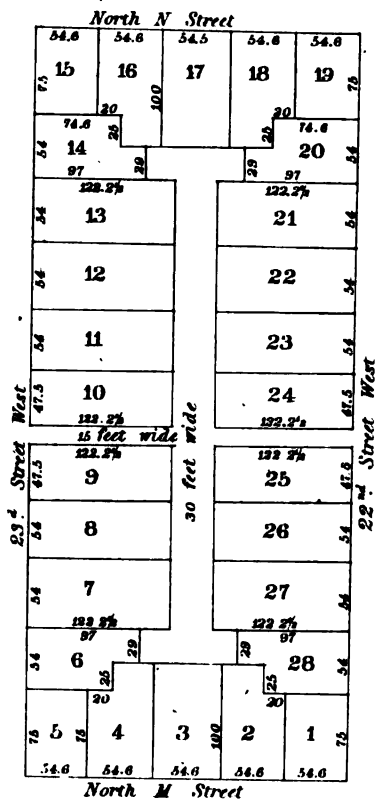

**SQUARE N°51**

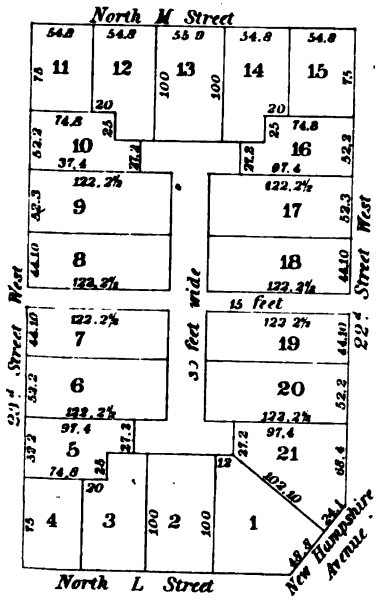

**SQUARE N°52**

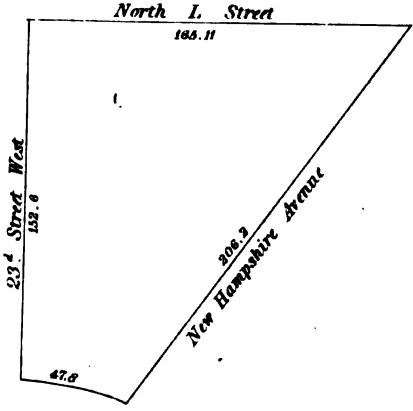





**SQUARE N° 53**

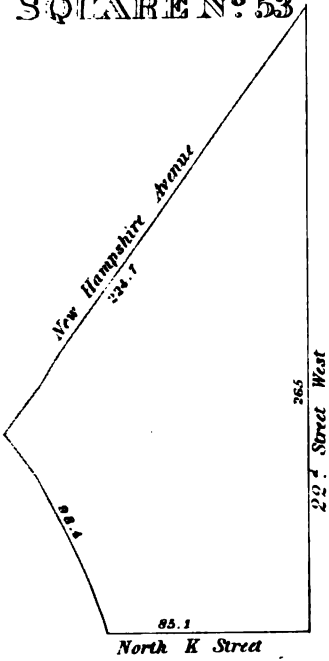

**SQUARE N° 54**

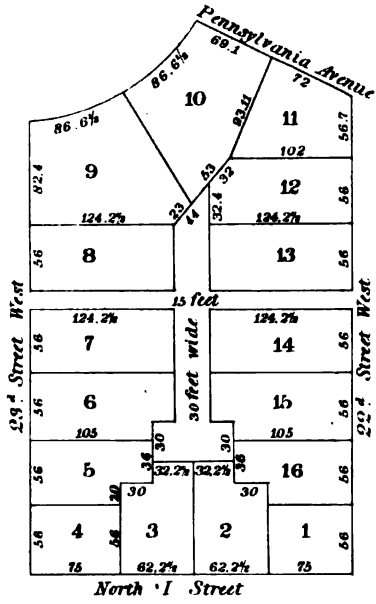

**SQUARE N° 55**

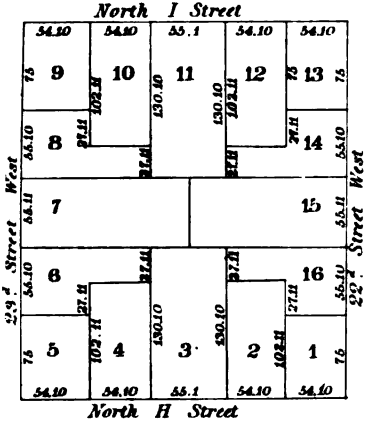

**SQUARE N° 56**

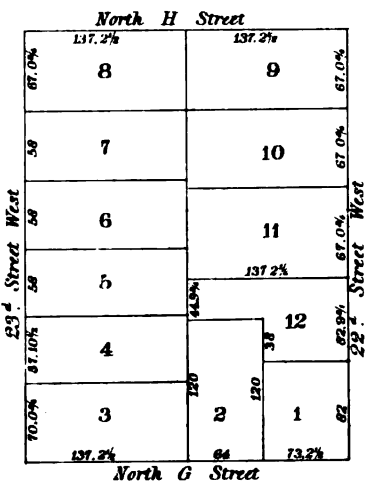

**SQUARE N° 57**

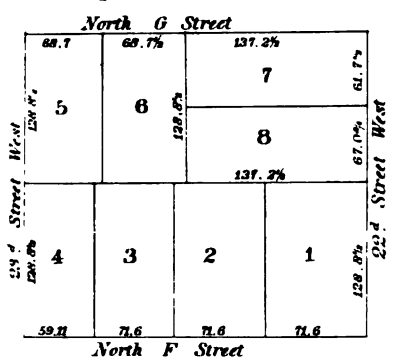

**SQUARE N° 58**

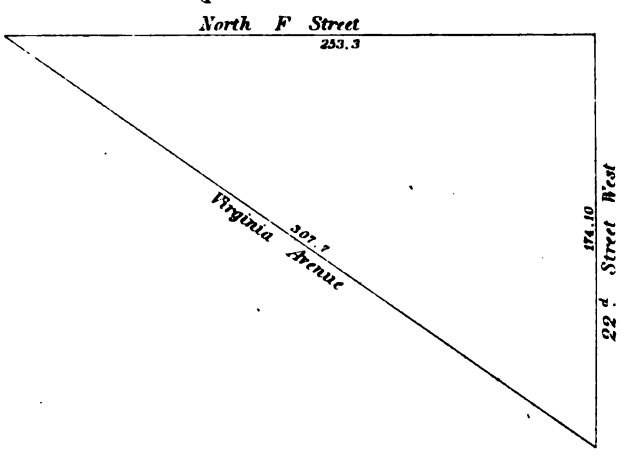

**SQUARE N° 59**

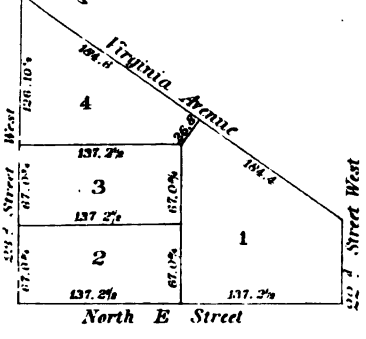

**SQUARE N° 60**

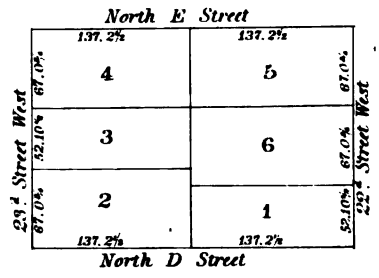



SQUARE N° 61

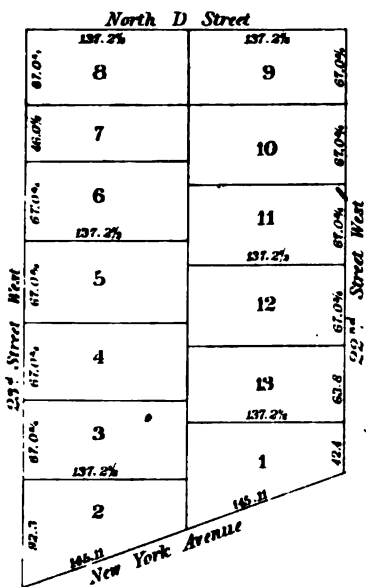

SQUARE N° 63

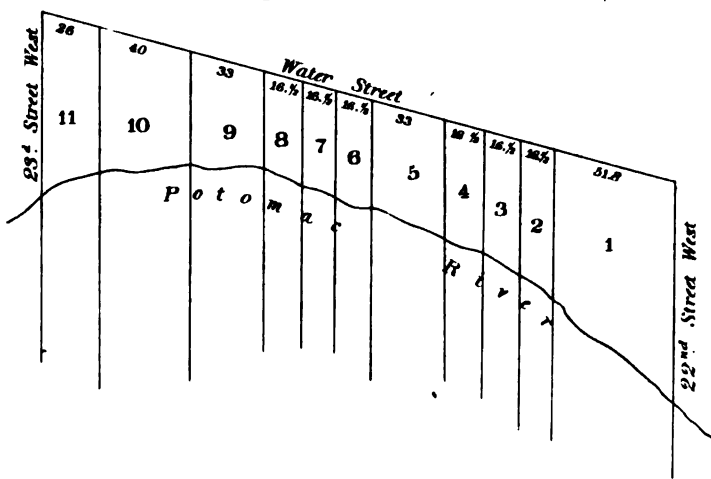

SQUARE N° 62

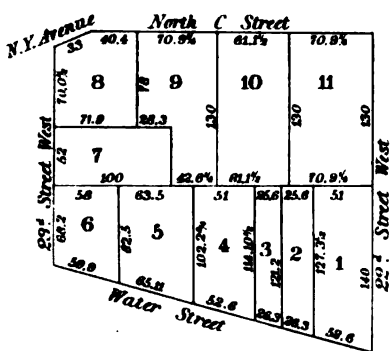

SQUARE N° 67

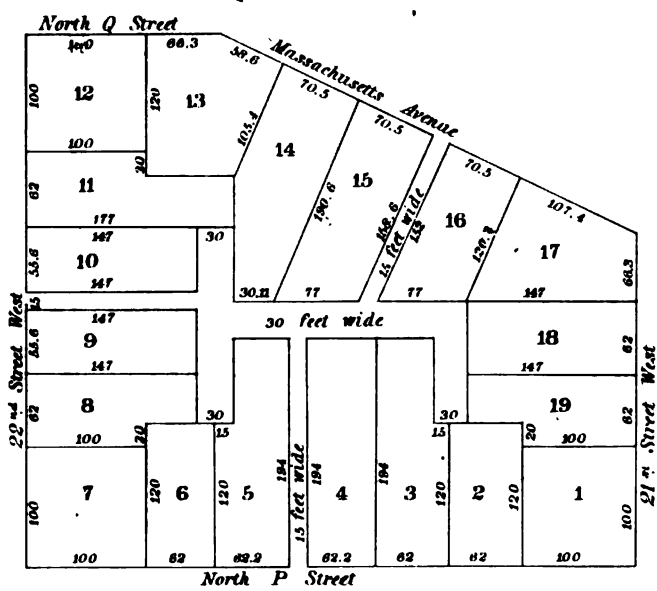

SQUARE N° 65

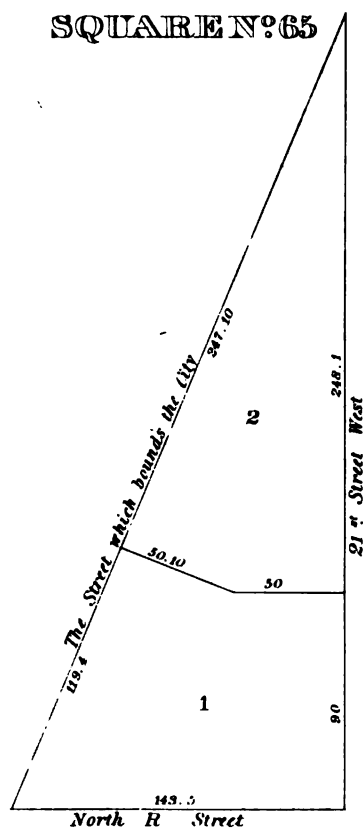

SQUARE N° 66

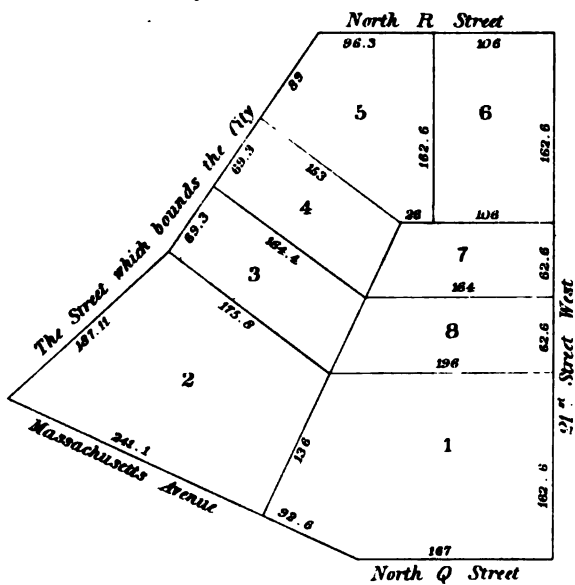



**SQUARE N°68**

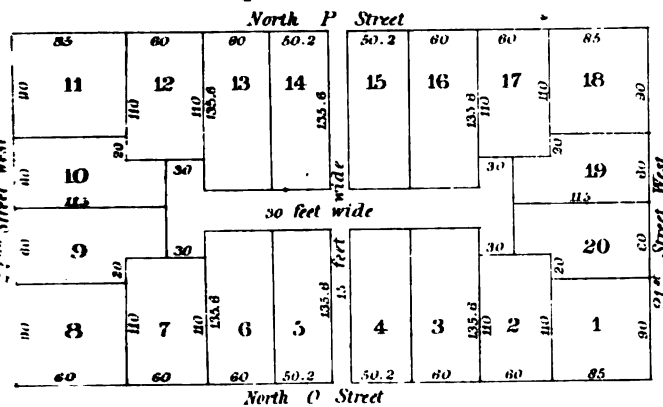

**SQUARE N°71**

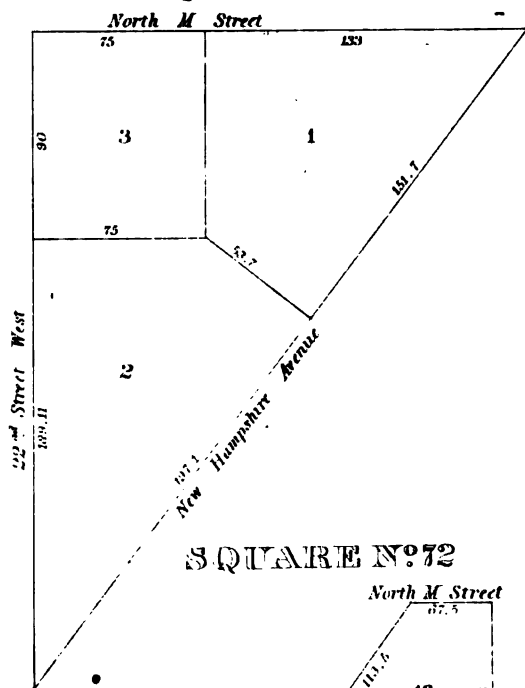

**SQUARE N°69**

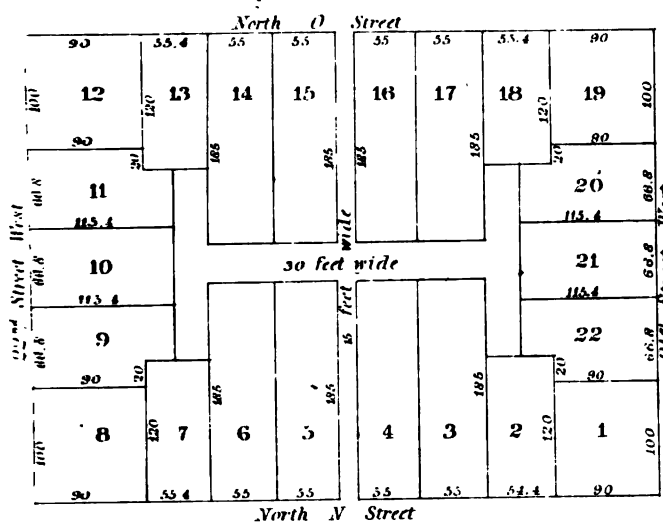

**SQUARE N°72**

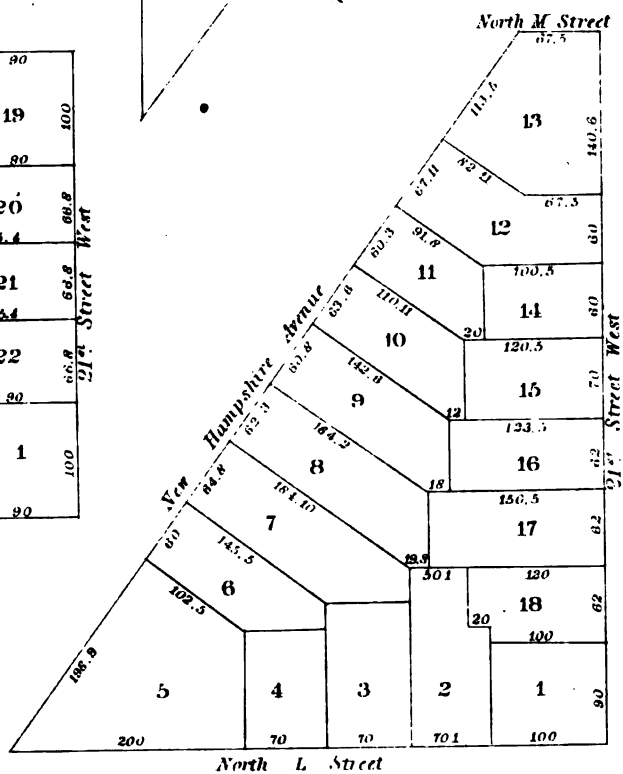

**SQUARE N°70**

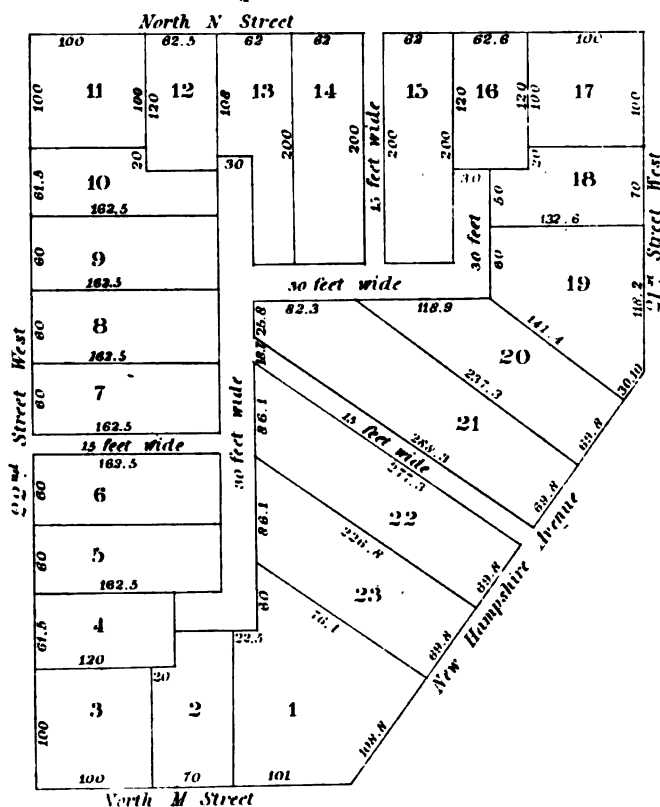

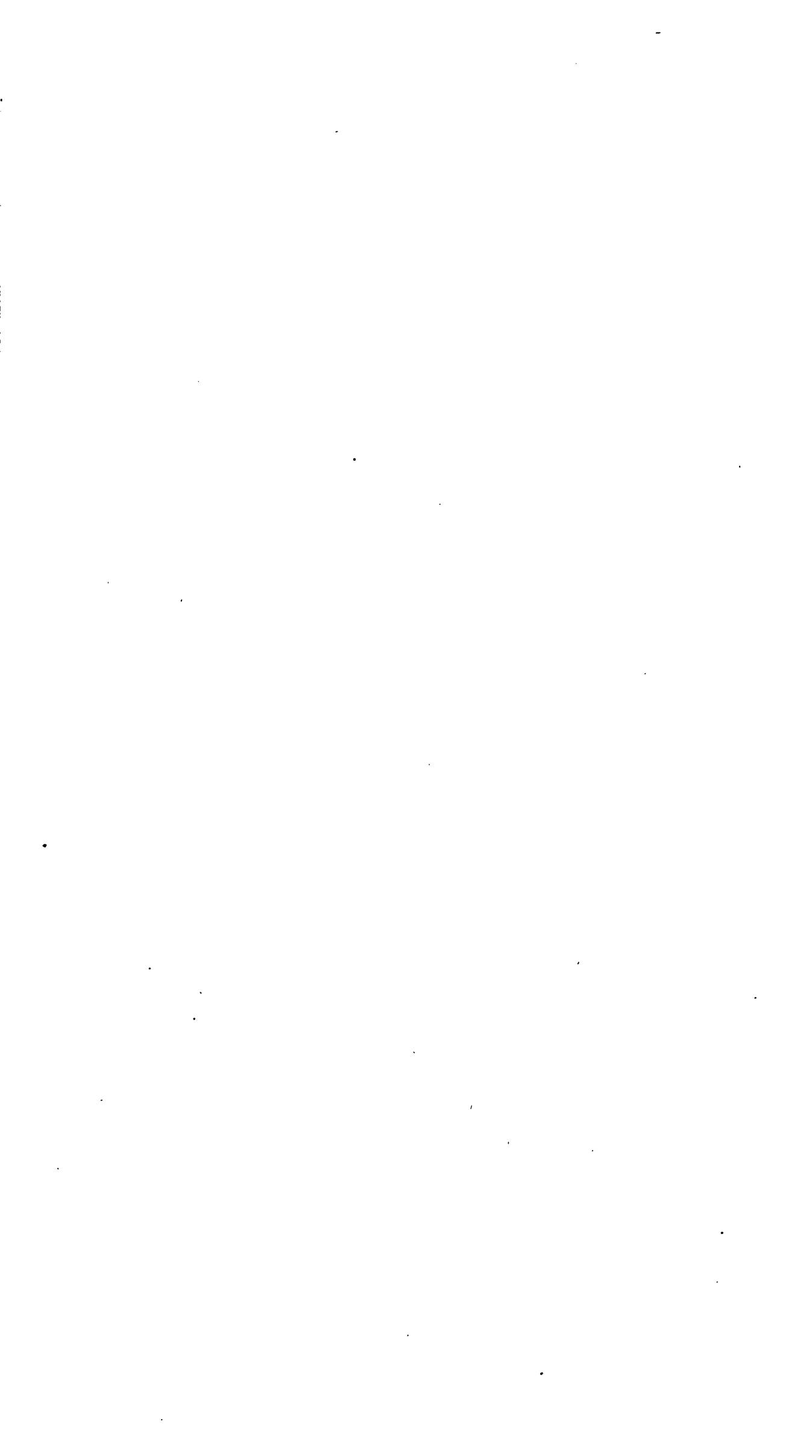

SQUARE N°73

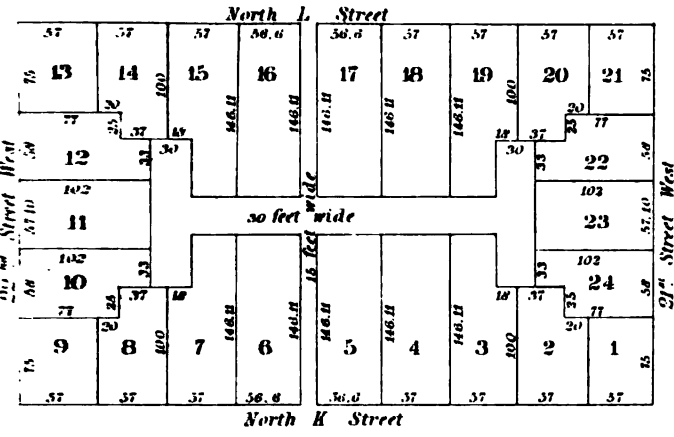

SQUARE N°76

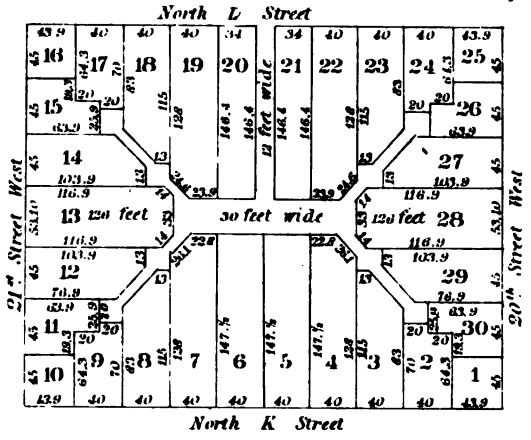

SQUARE N°75

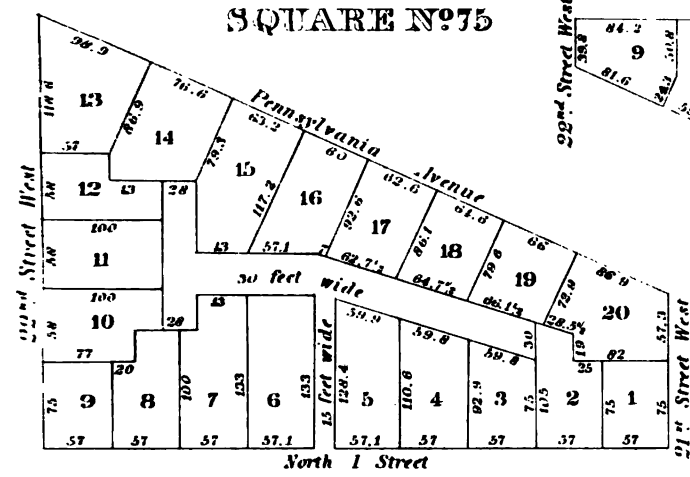

SQUARE N°74

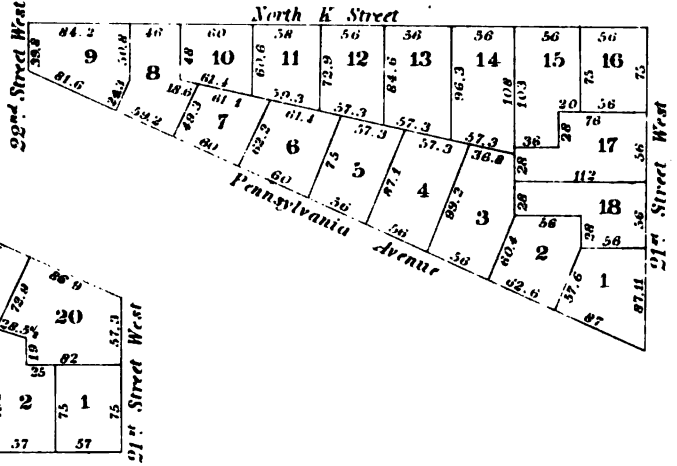

SQUARE N°77

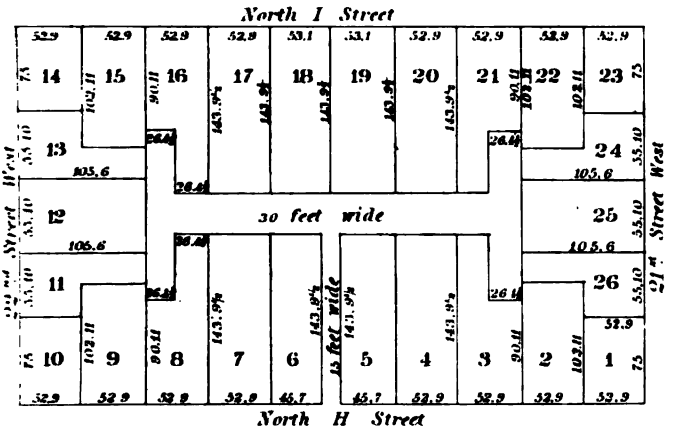

SQUARE N°78

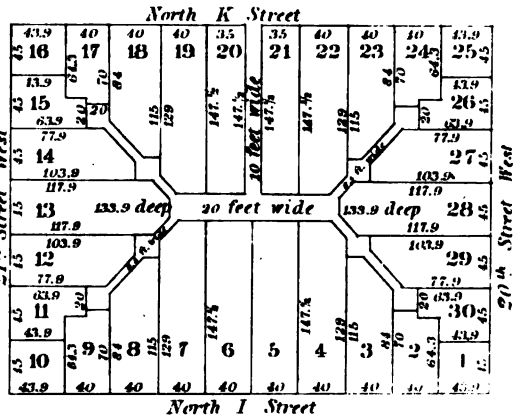

SQUARE N°79

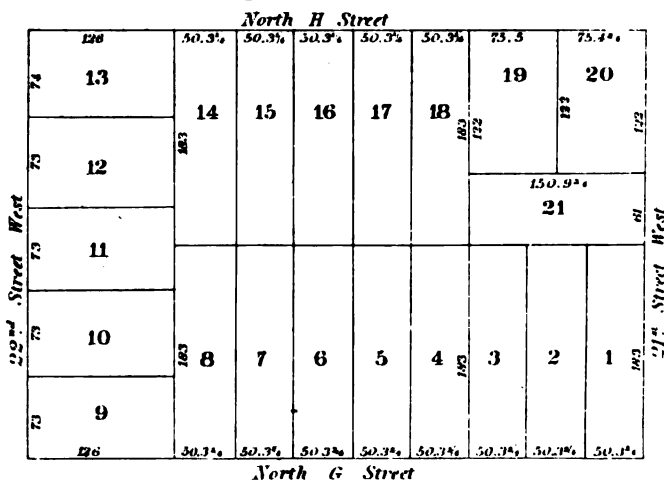



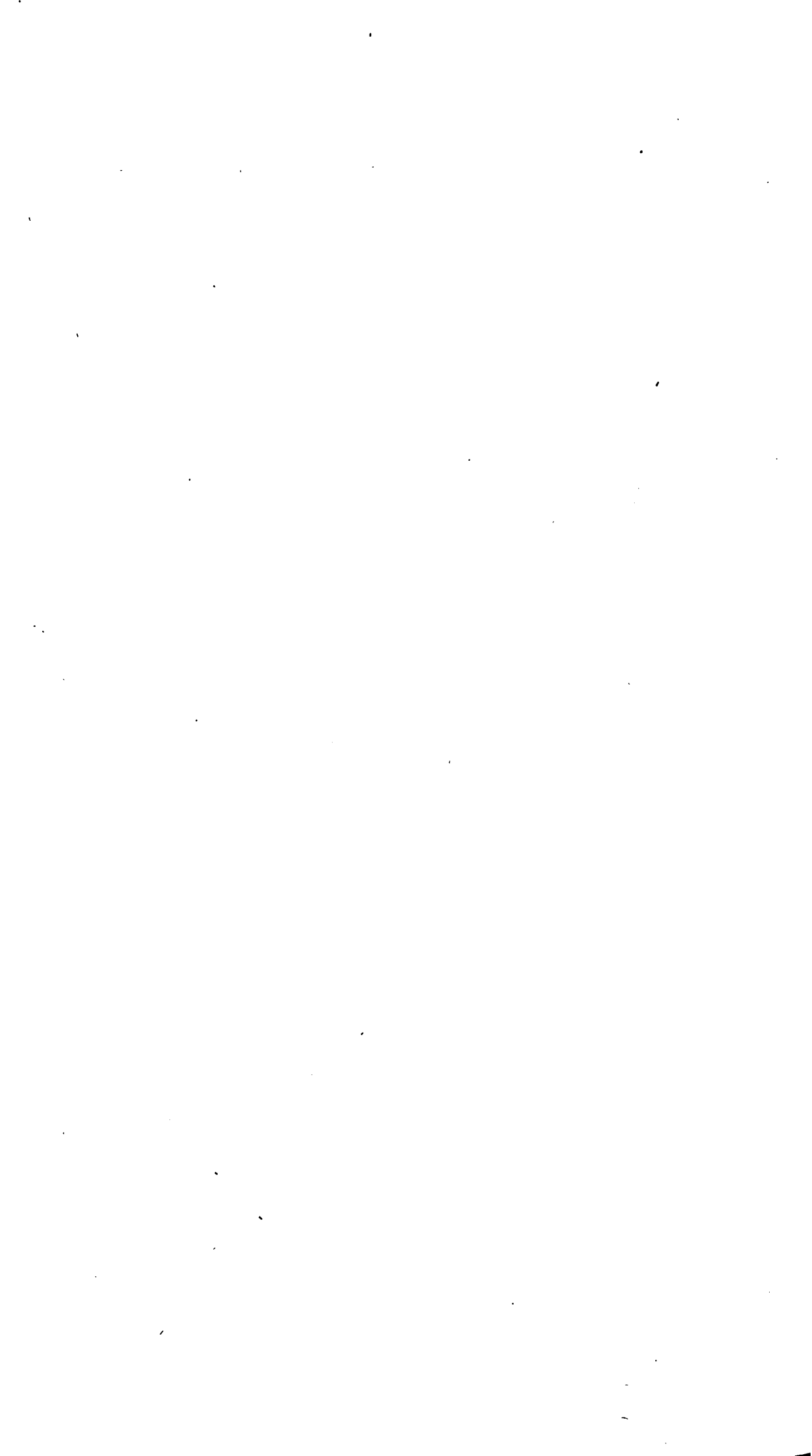

**SQUARE N°80**

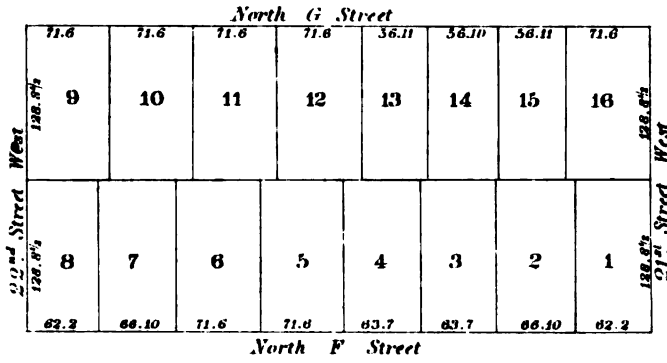

**SQUARE N°83**

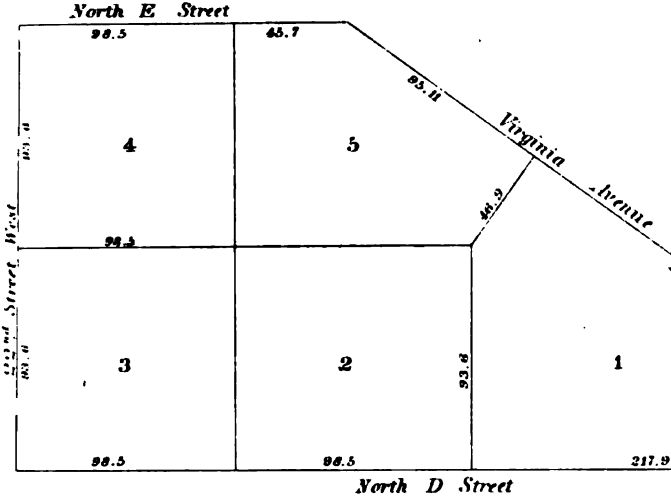

**SQUARE N°82**

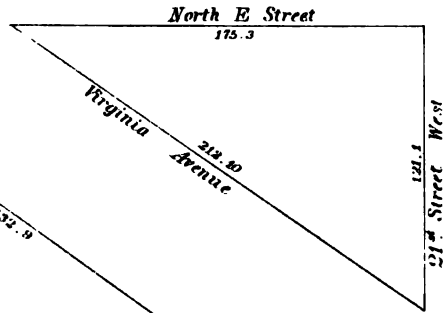

**SQUARE N°84**

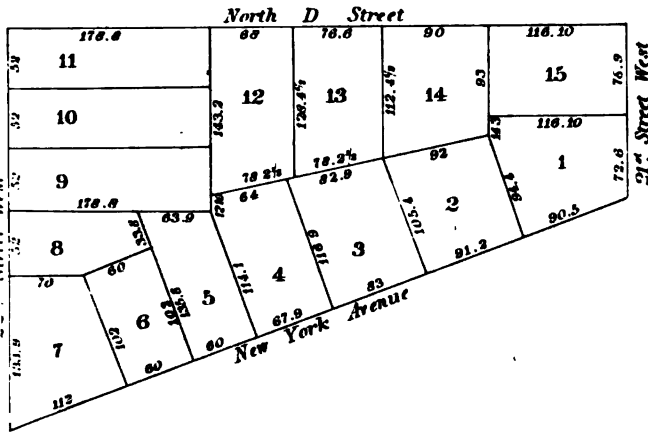

**SQUARE N°85**

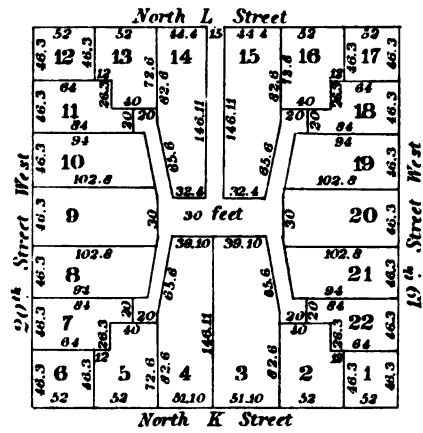

**SQUARE N°86**

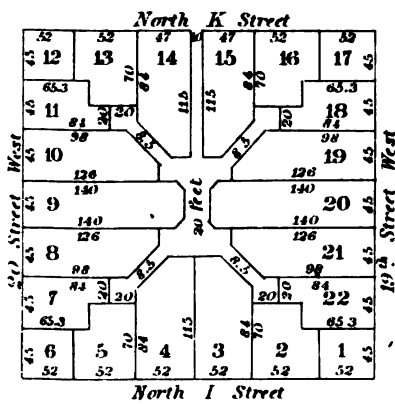

**SQUARE N°81**

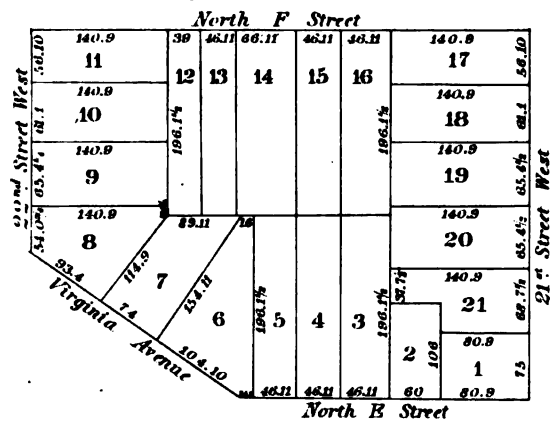

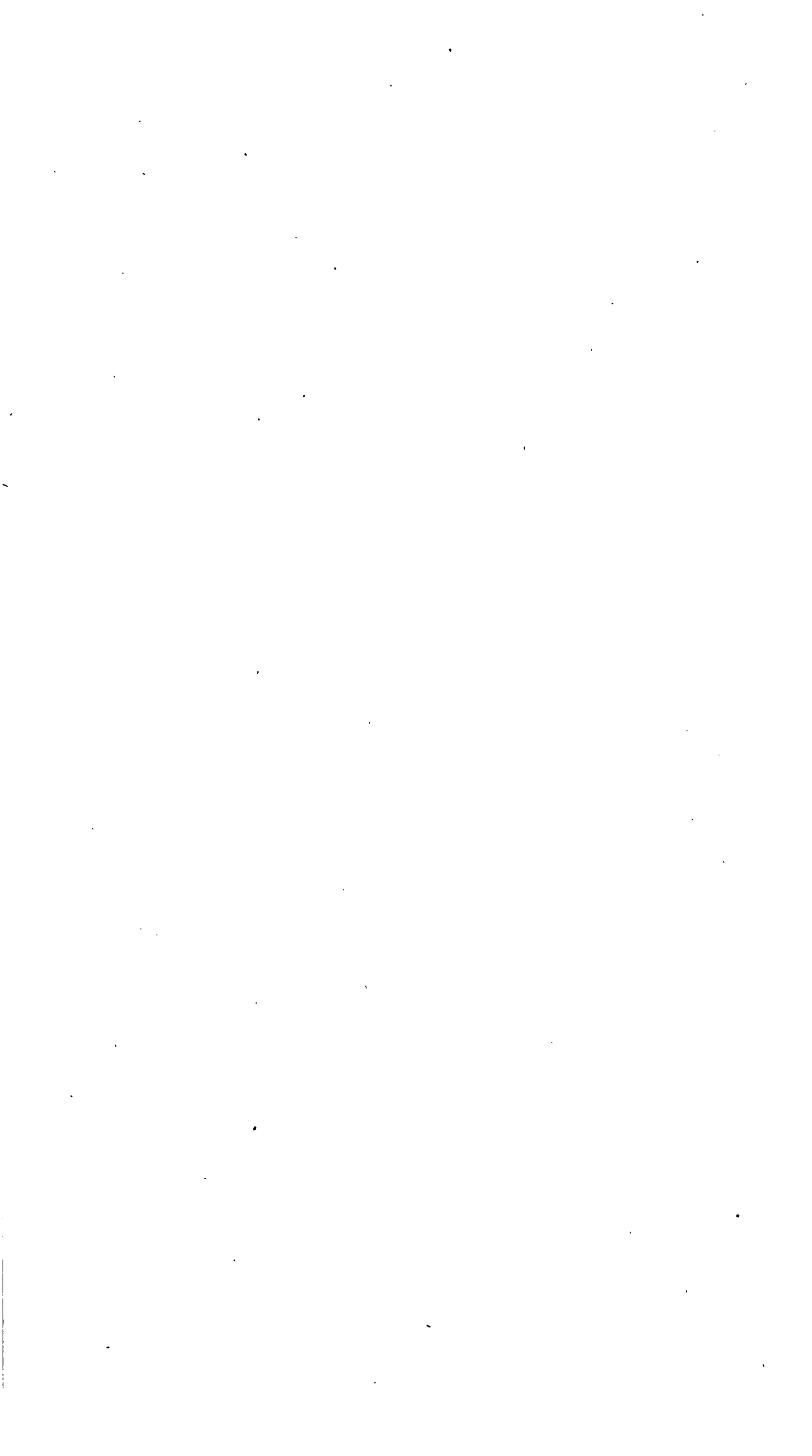

**SQUARE N°87**

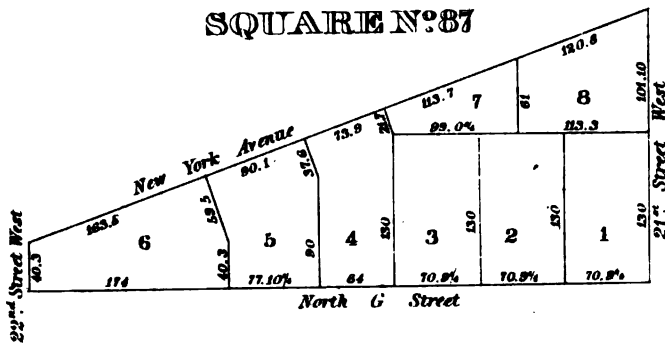

**SQUARE E. OF N°87**

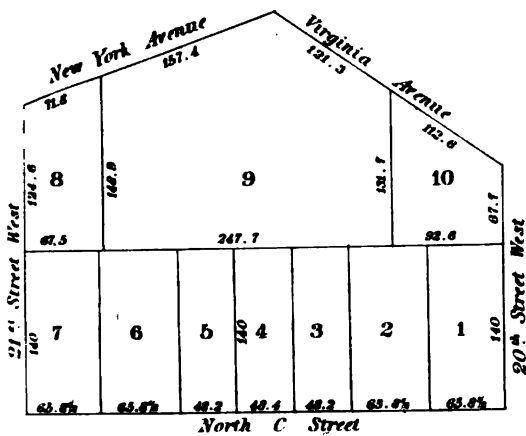

**SQUARE N°90**

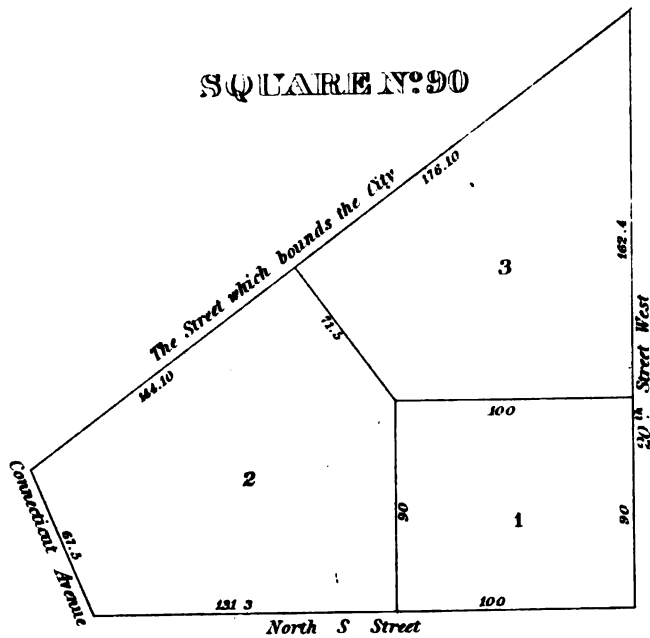

**SQUARE N°88**

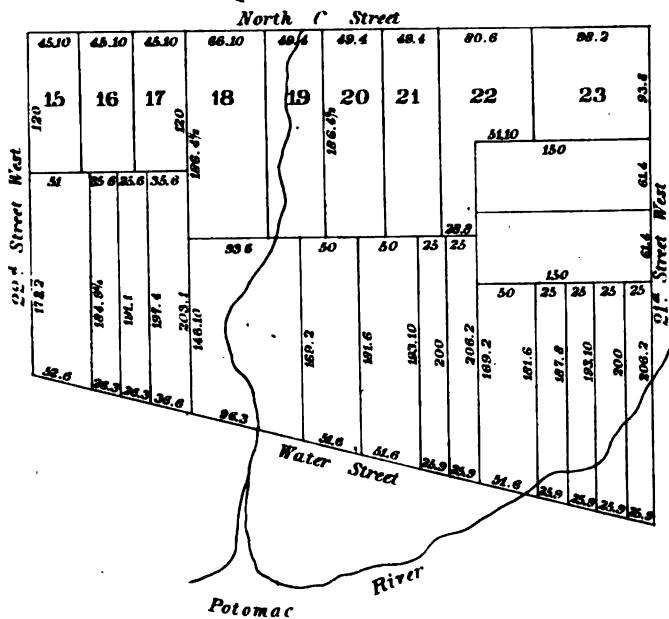

**SQUARE N°91**

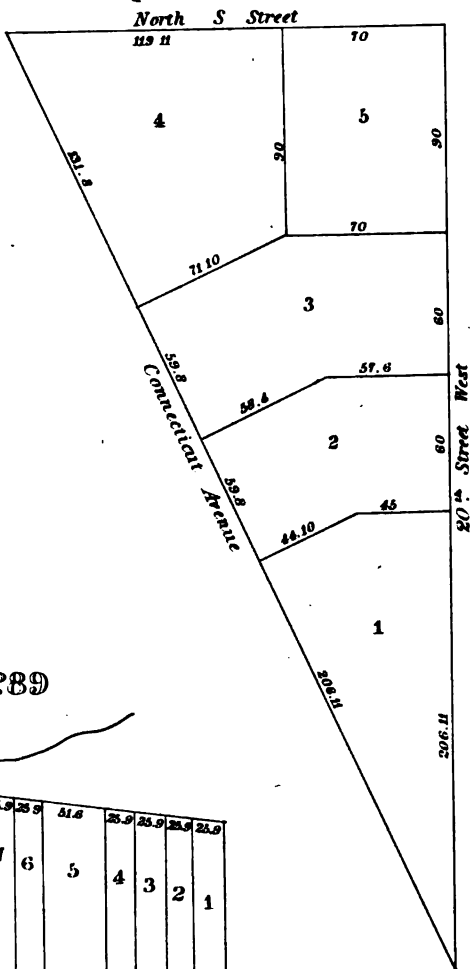

**SQUARE N°89**

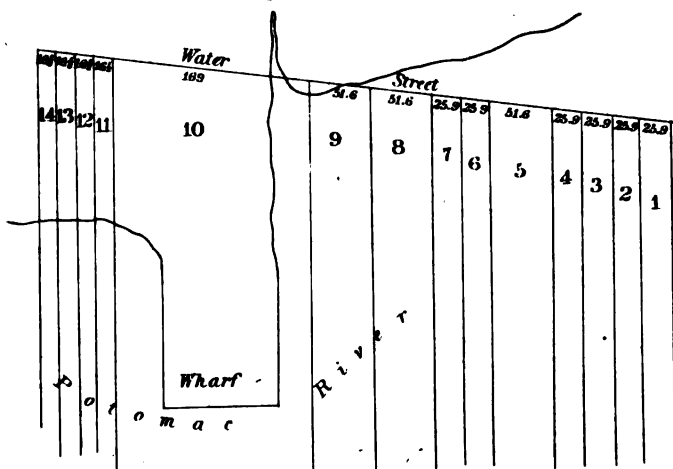



**SQUARE N°92**

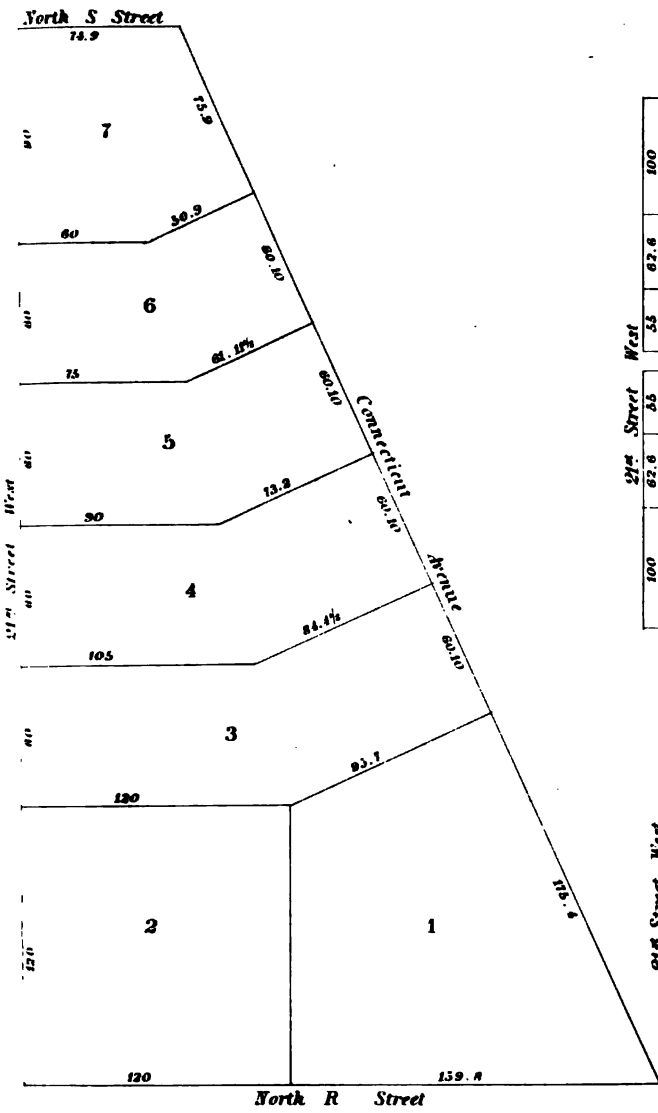

**SQUARE N°93**

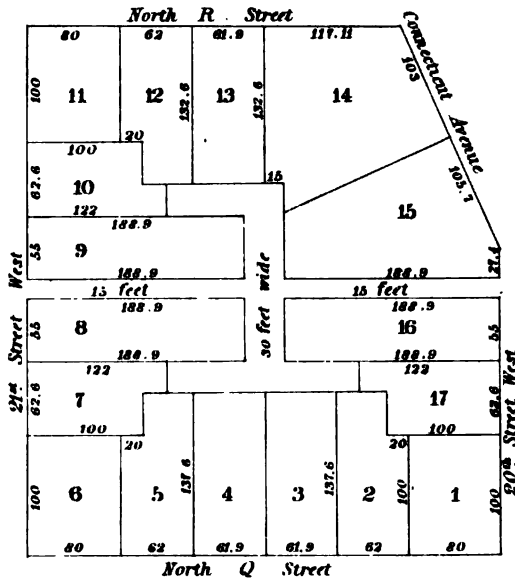

**SQUARE N°95**

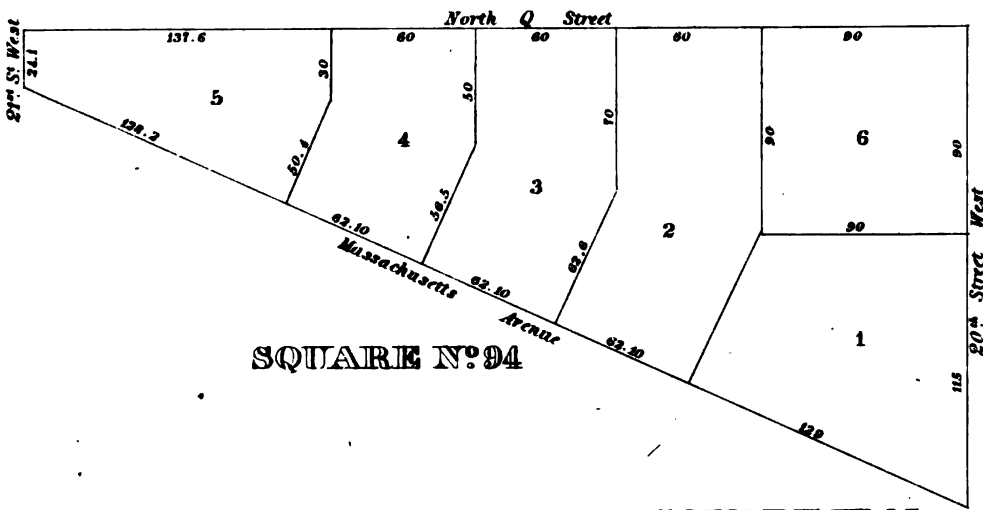
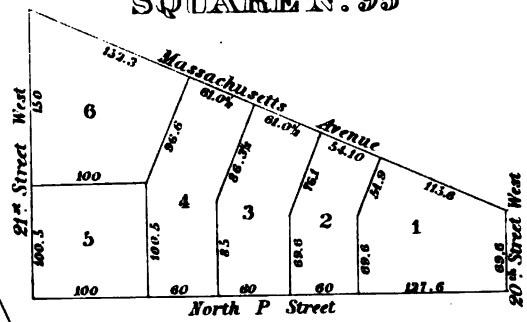

**SQUARE N°97**

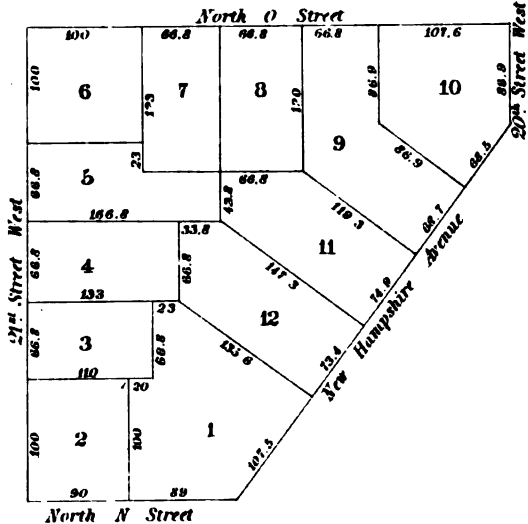

**SQUARE N°96**

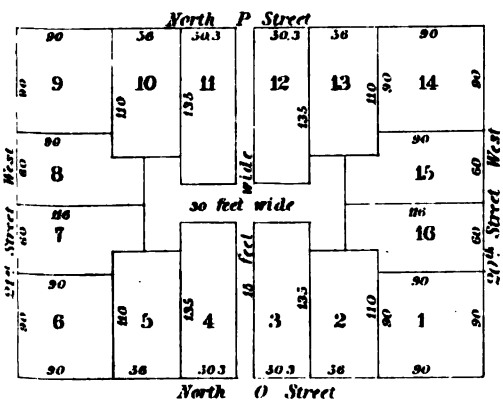



SQUARE N° 98

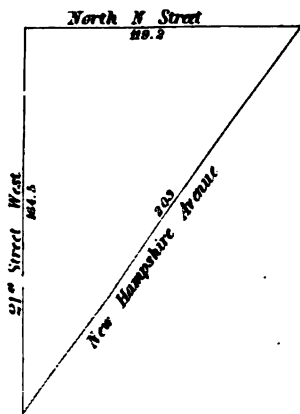

SQUARE N. OF N° 99

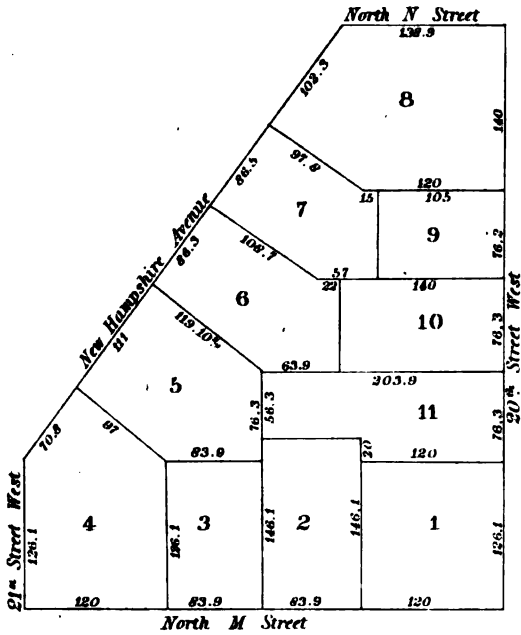
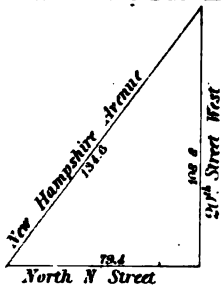

SQUARE N° 100

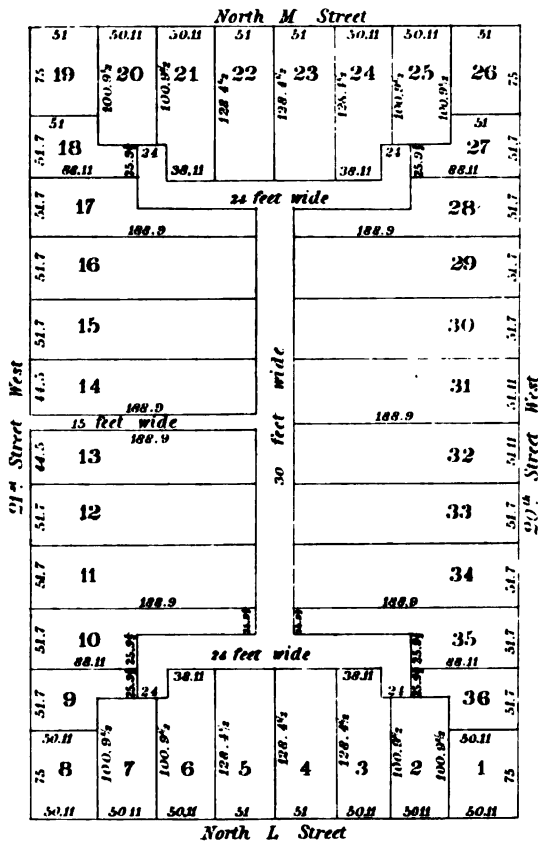

SQUARE N° 101

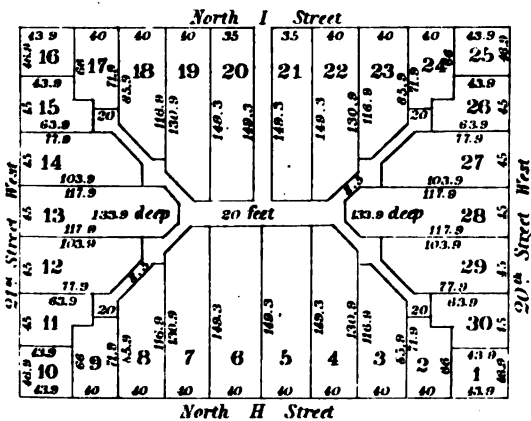

SQUARE N° 102

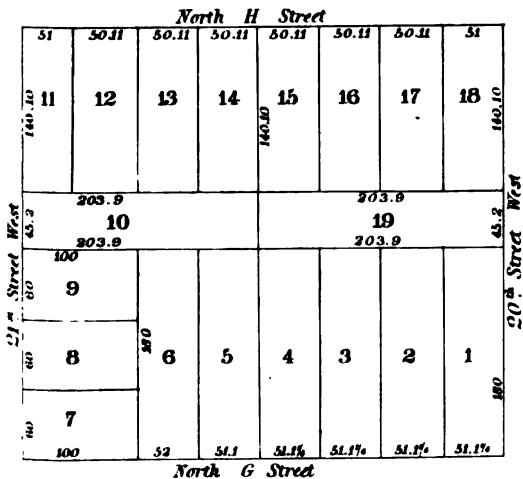

SQUARE N° 103

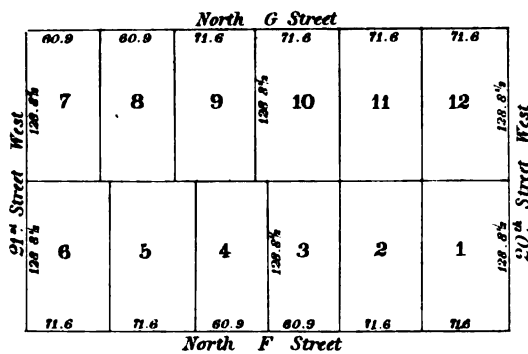





### SQUARE N<sup>o</sup>104

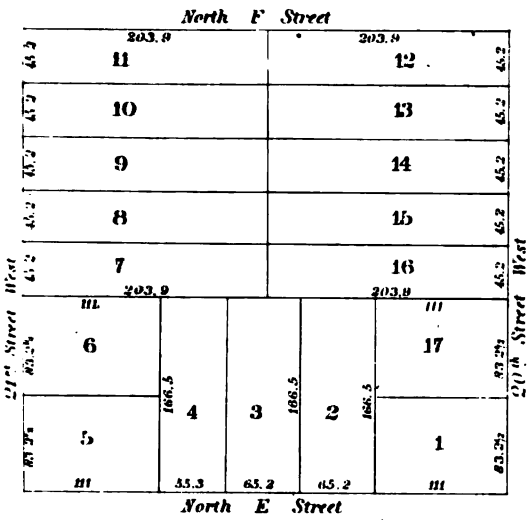

### SQUARE S. OF N<sup>o</sup>104

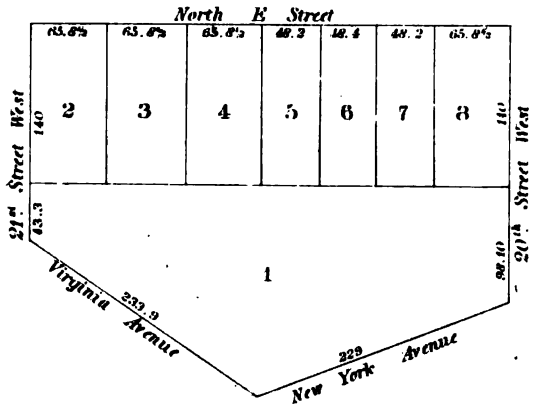

### SQUARE N<sup>o</sup>105

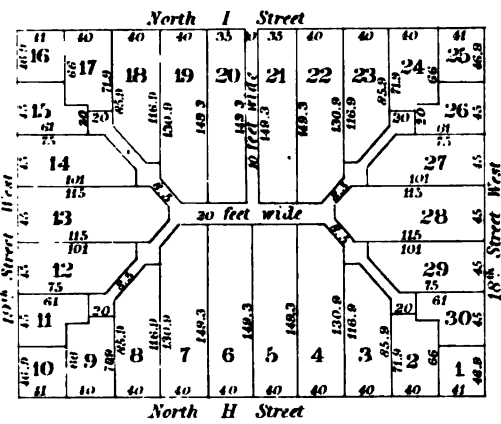

### SQUARE N<sup>o</sup>106

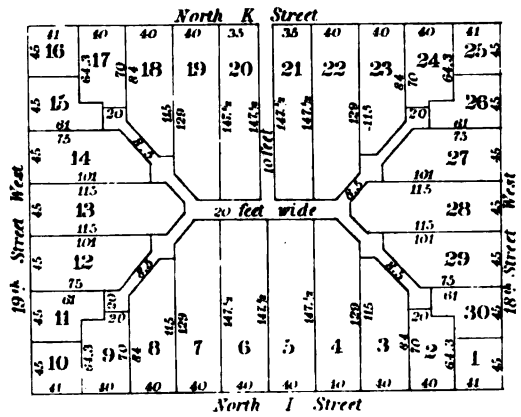

### SQUARE N<sup>o</sup>109

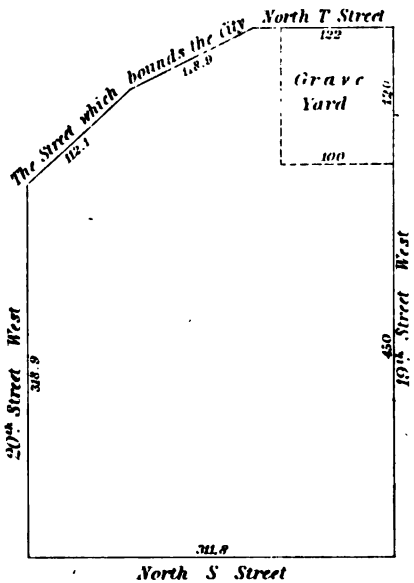

### SQUARE N<sup>o</sup>107

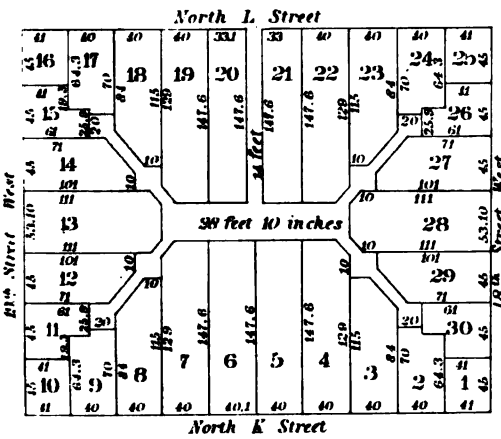

### SQUARE N<sup>o</sup>110

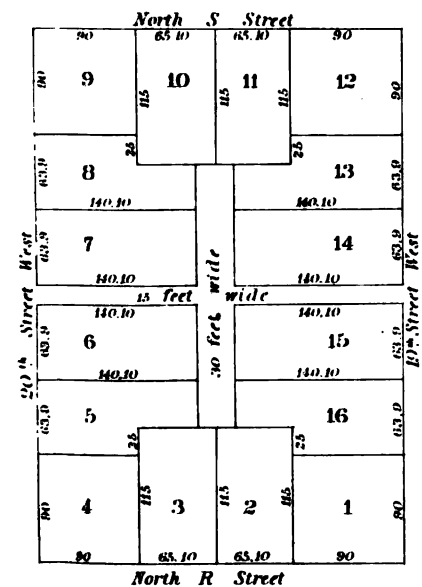

### SQUARE N<sup>o</sup>111

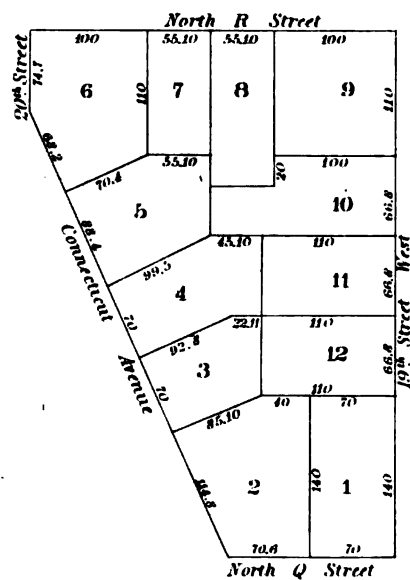



SQUARE N°112

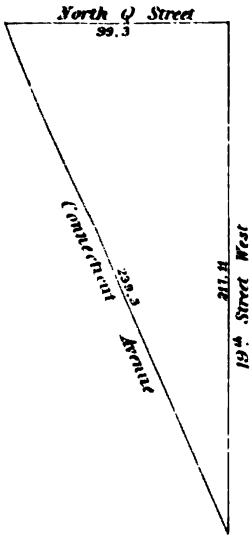

SQUARE N°113

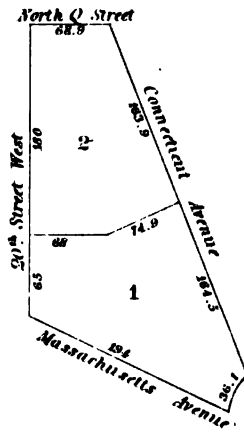

SQUARE N°114

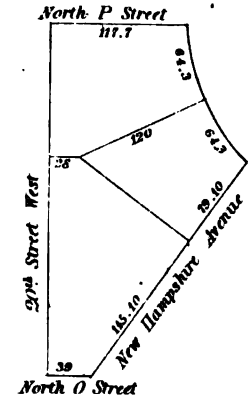

SQUARE N°115

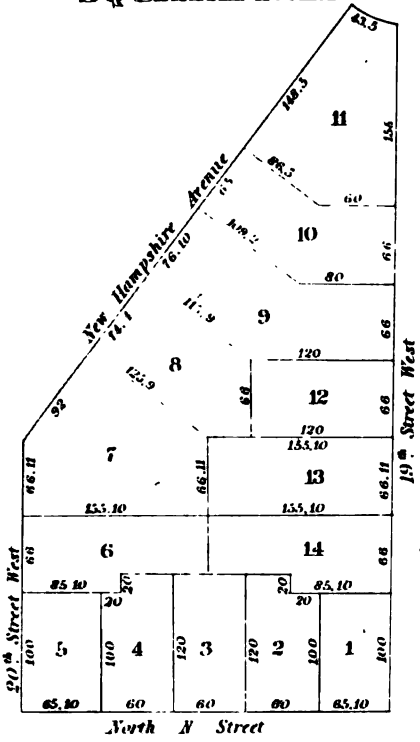

SQUARE N°116

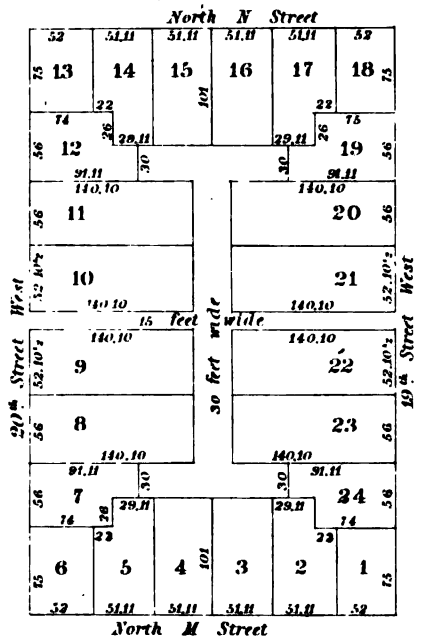

SQUARE N°117

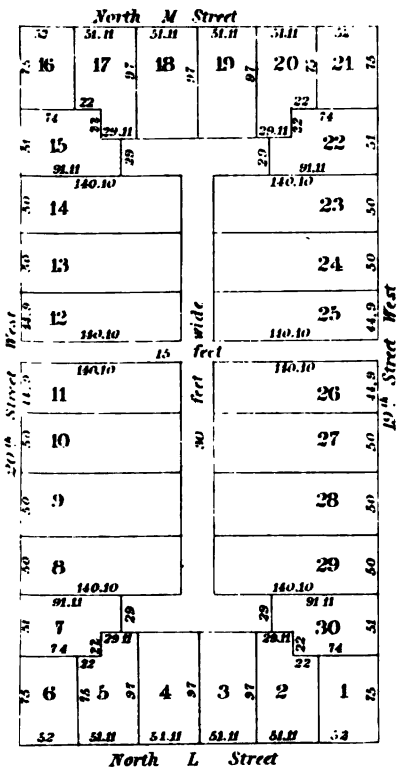

SQUARE N°118

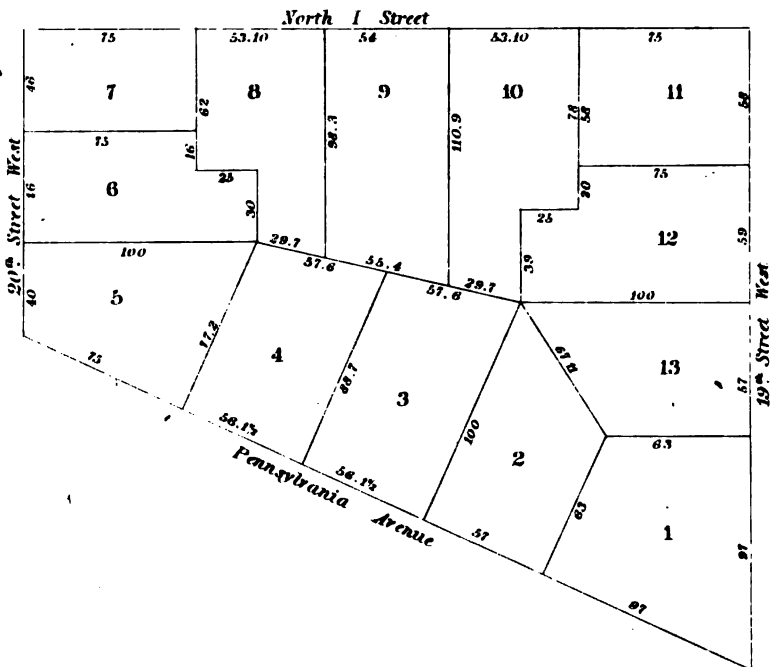



### SQUARE N°127

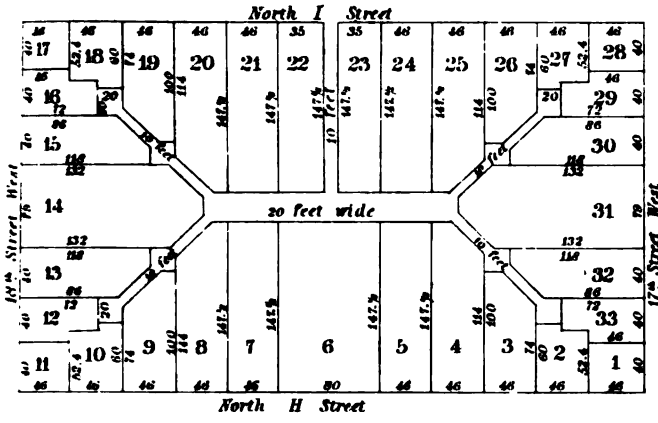

### SQUARE N.OF N°128

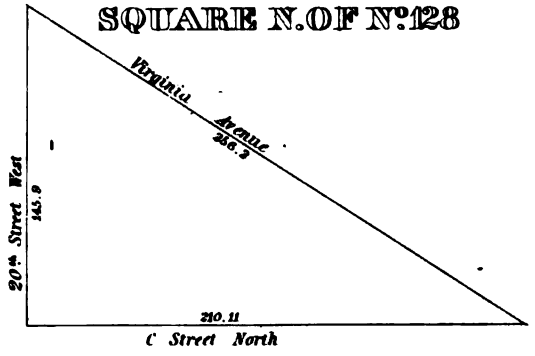

### SQUARE N°129

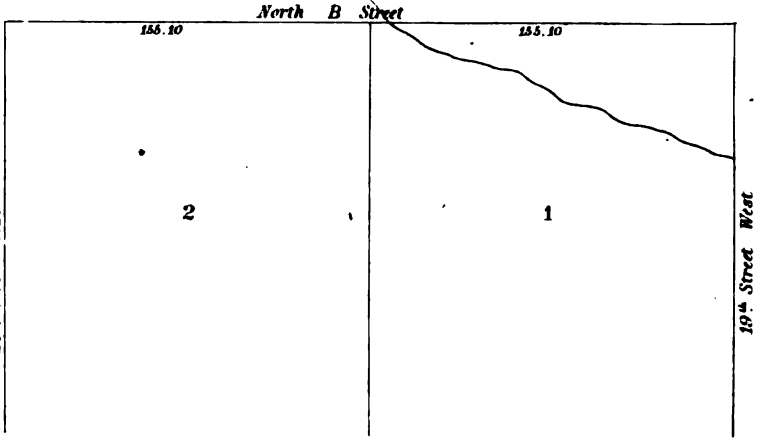

### SQUARE N°128

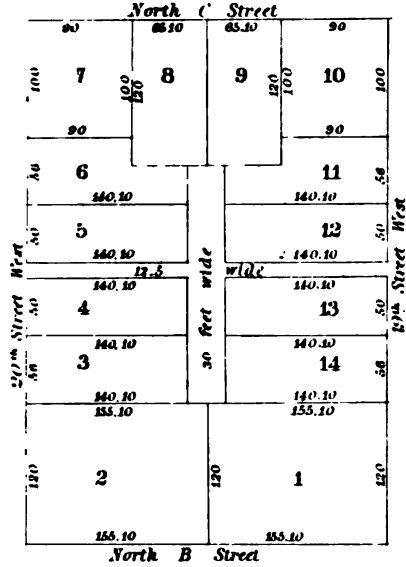

### SQUARE N°132

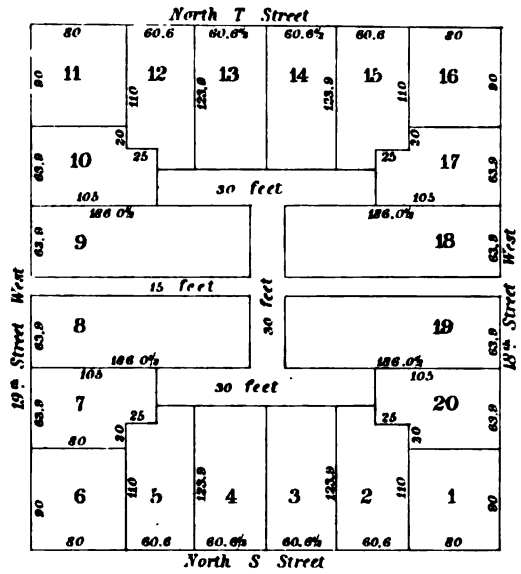

### SQUARE N°131

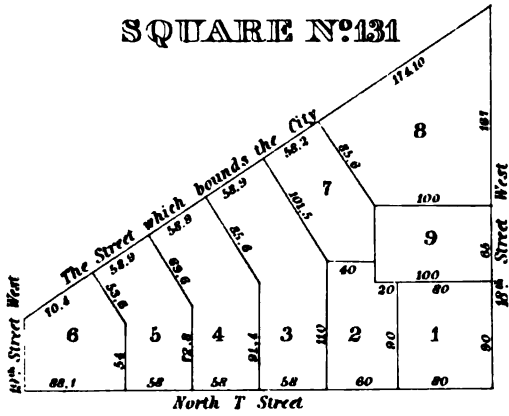

### SQUARE N°133

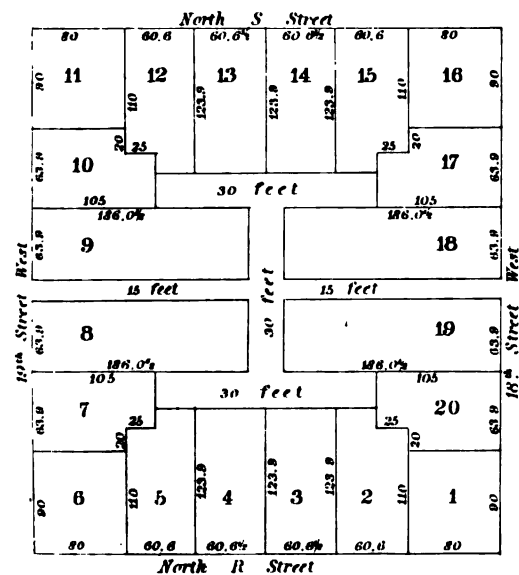

### SQUARE N°134

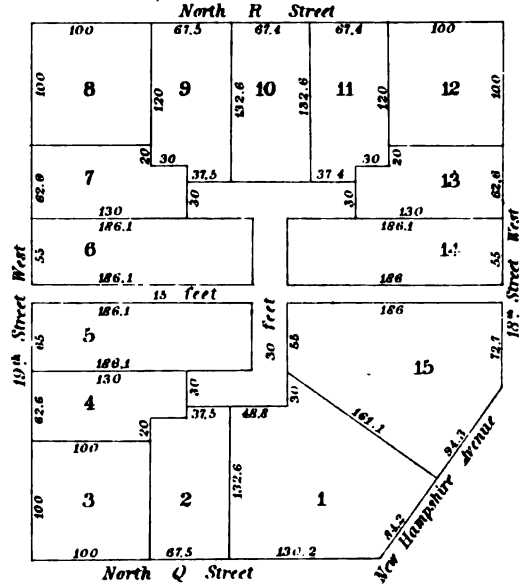



**SQUARE N°135**

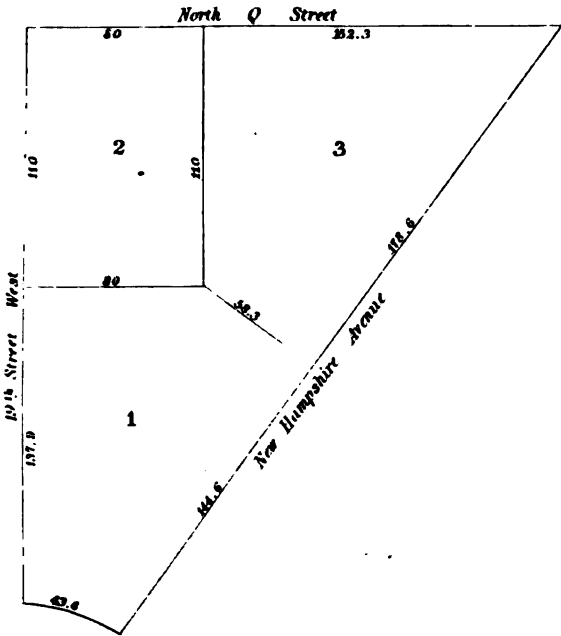

**SQUARE N°137**

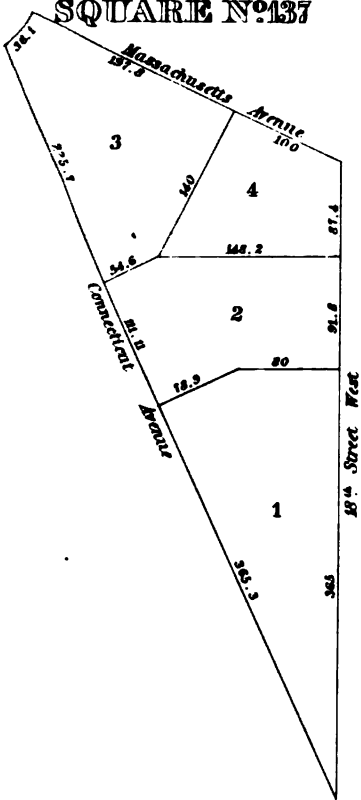

**SQUARE N°138**

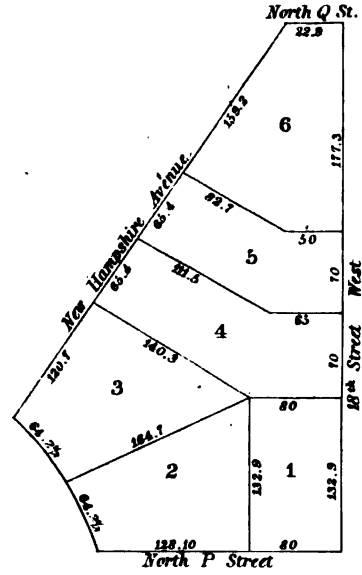
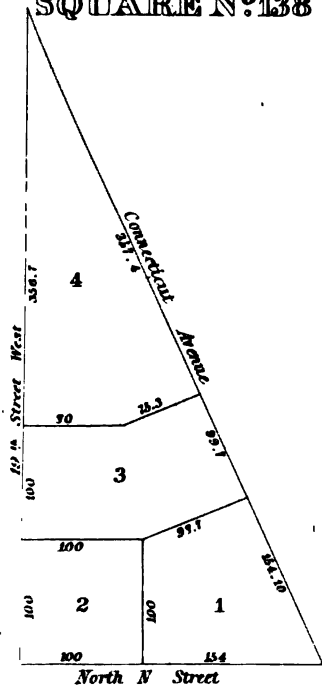

**SQUARE N. OF N°137**

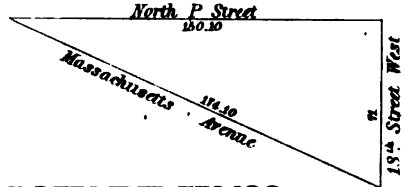

**SQUARE N°139**

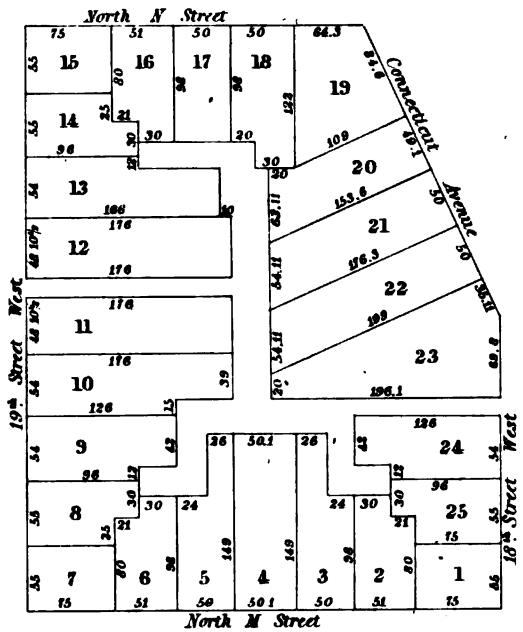

**SQUARE N°140**

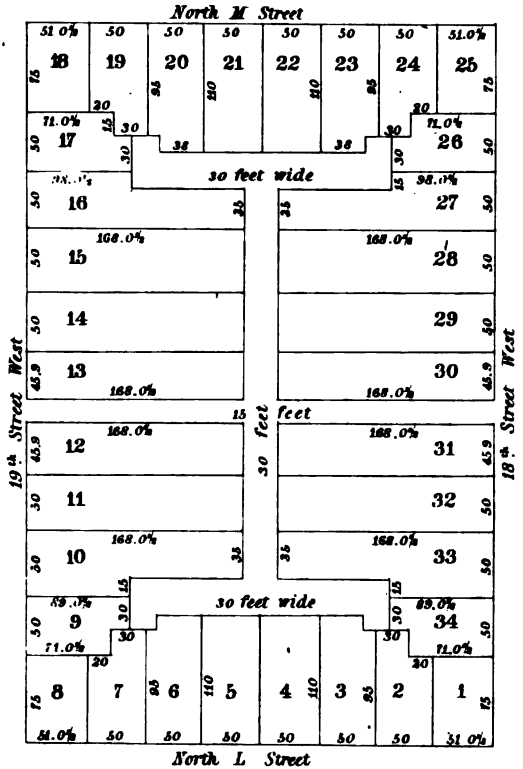



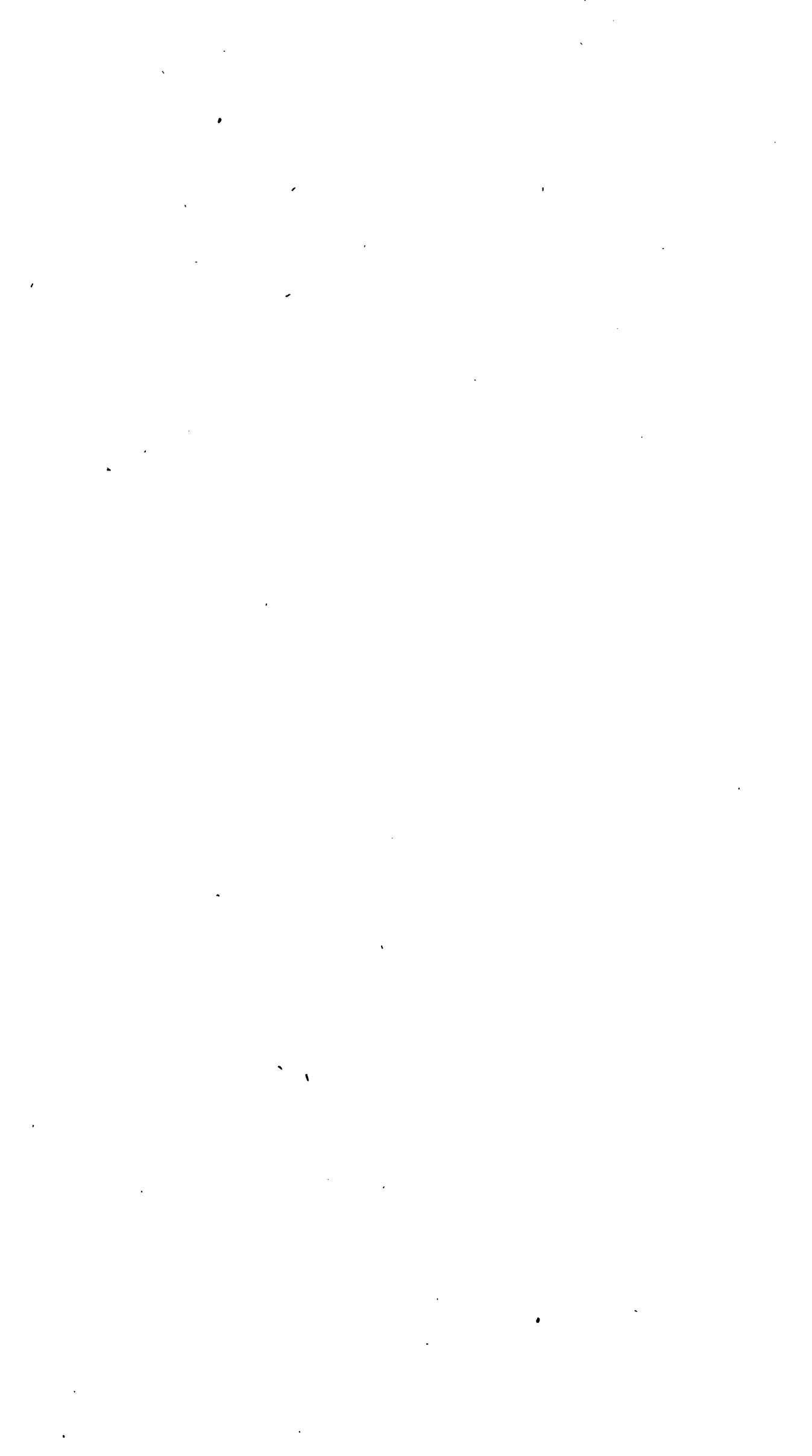

### SQUARE N°141

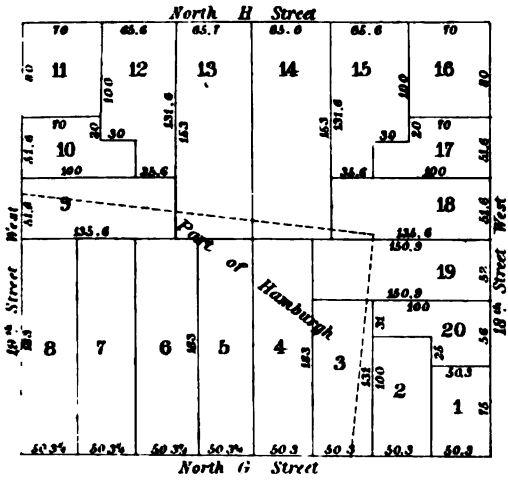

### SQUARE N°142

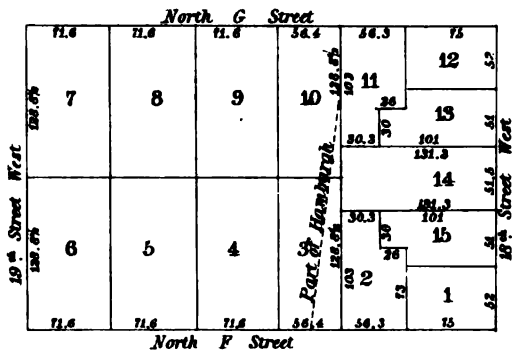

### SQUARE N°143

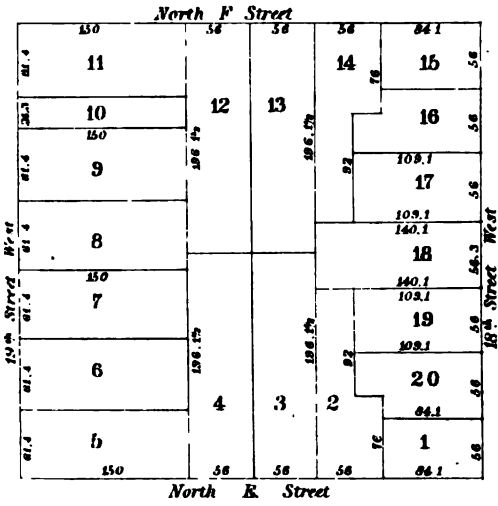

### SQUARE N°144

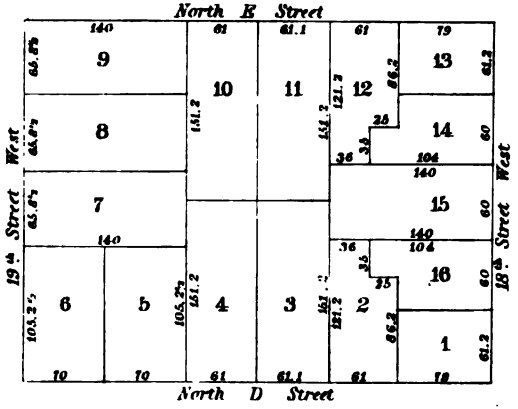

### SQUARE N°145

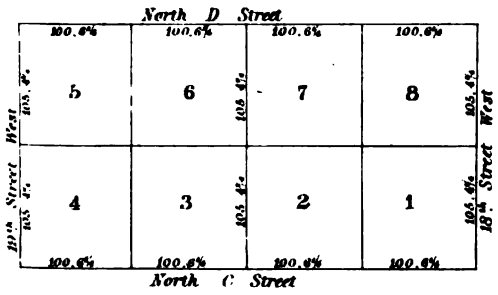

### SQUARE N°147

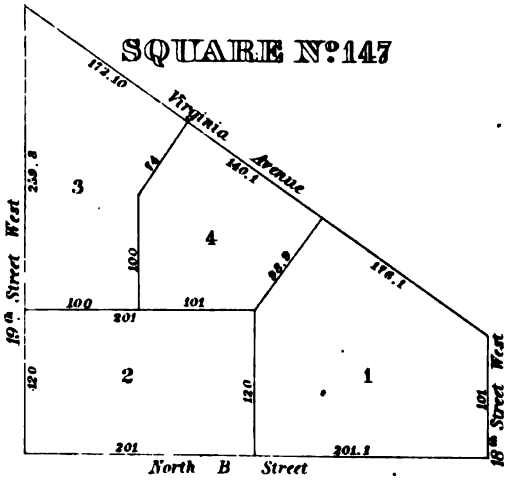

### SQUARE N°146

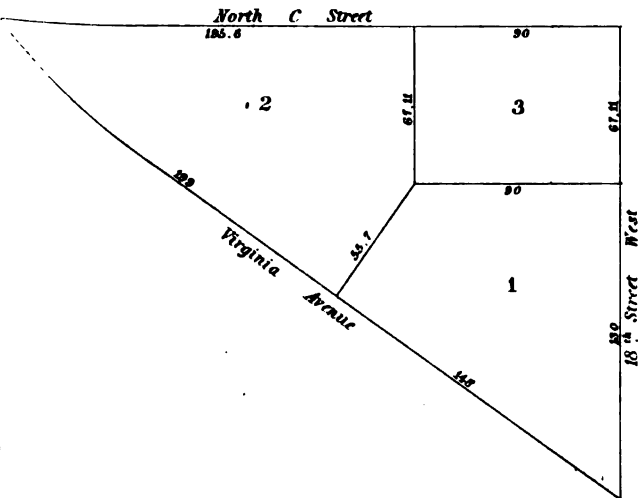

### SQUARE N°148

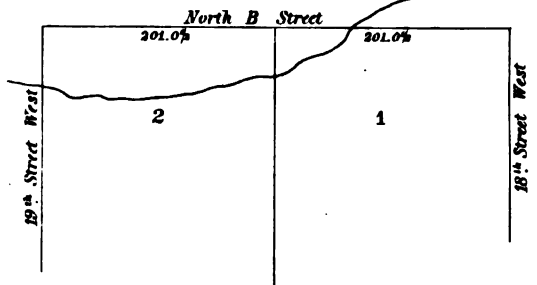

### SQUARE N°149

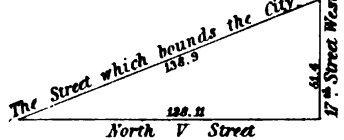



**SQUARE N°150**

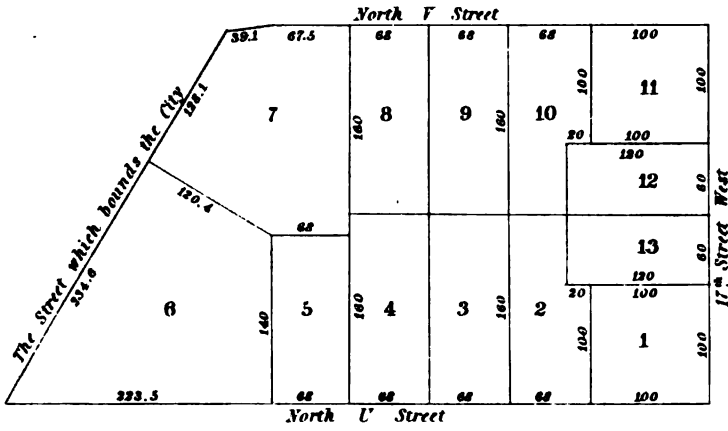

**SQUARE N°151**

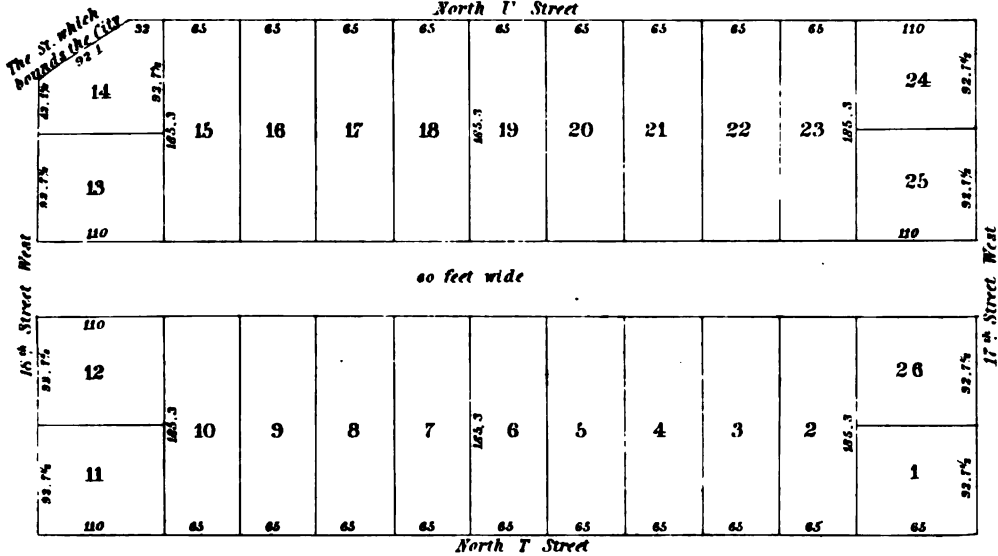

**SQUARE N°152**

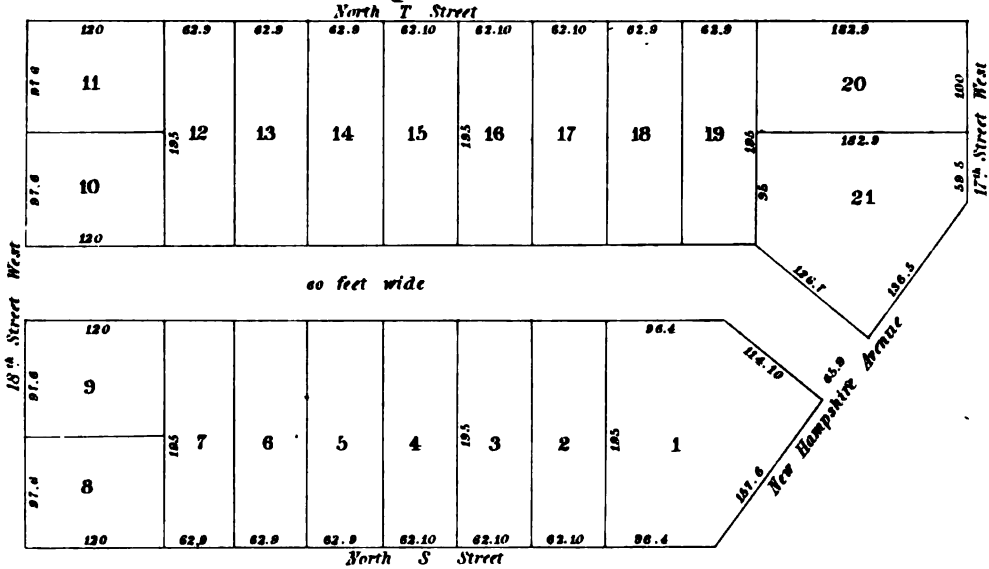

**SQUARE N°153**

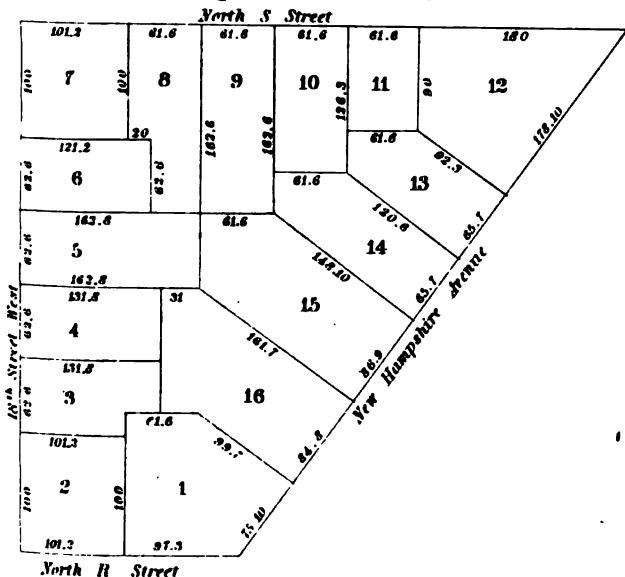

**SQUARE S. OF N°153**

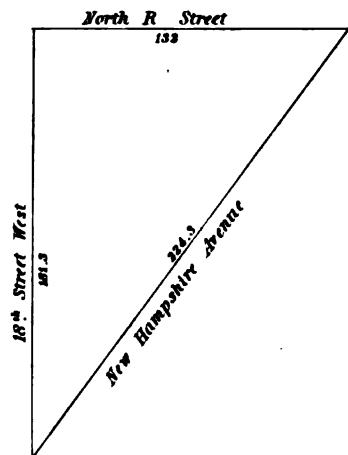



### SQUARE N° 154

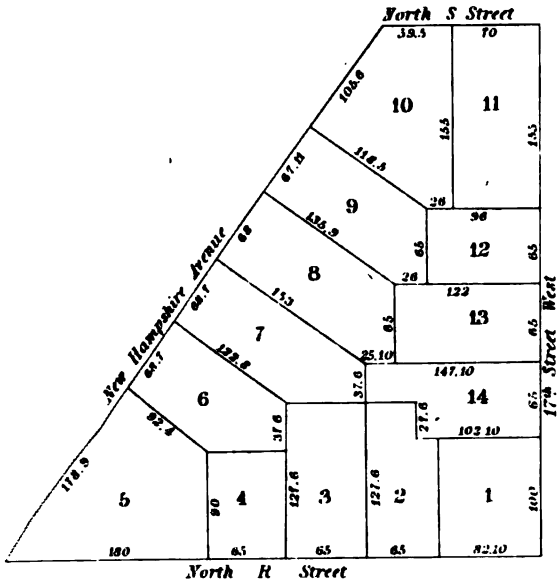

### 18th Street West No. 10

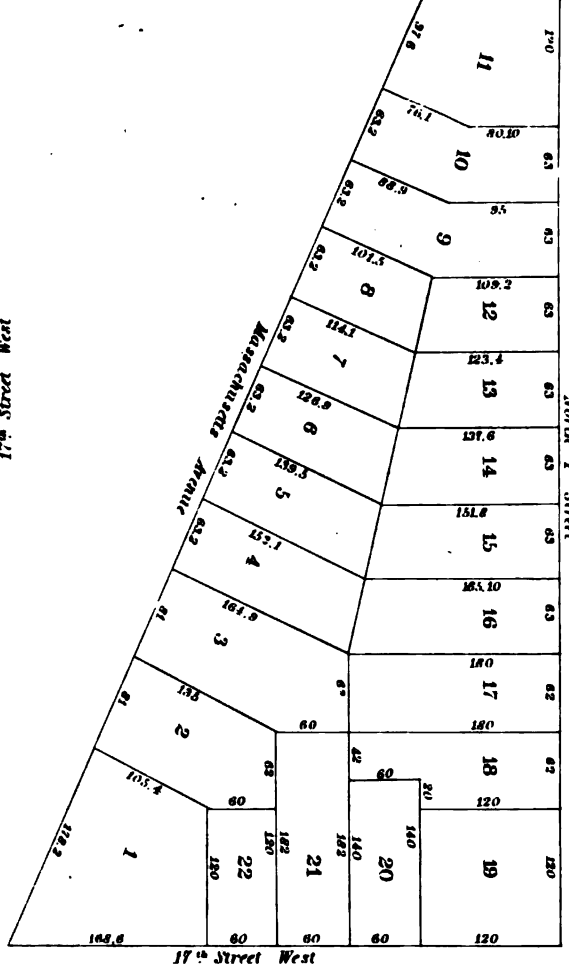

### SQUARE N° 157

### SQUARE N° 155

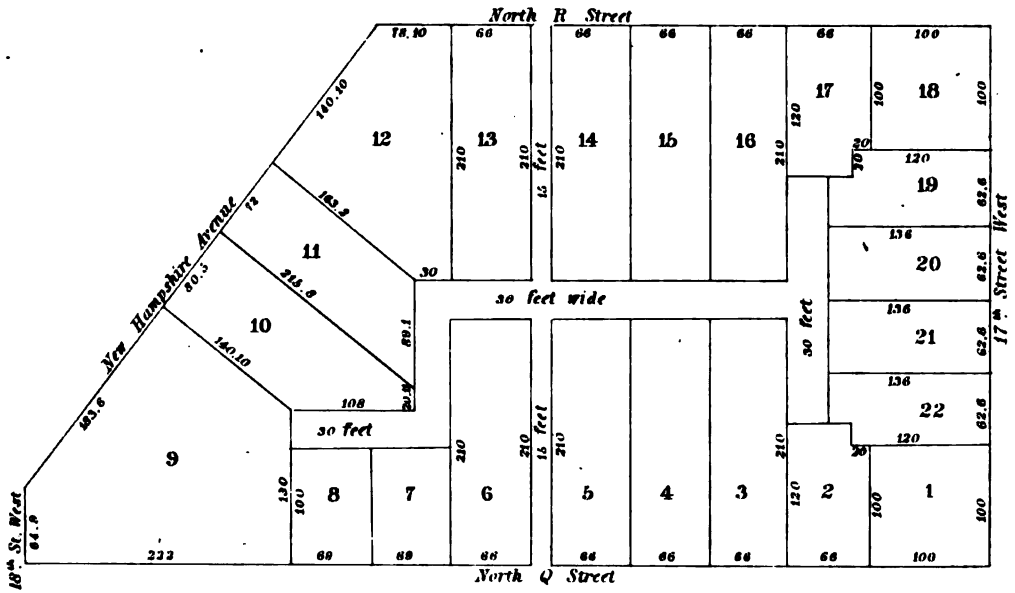

### SQUARE N° 156

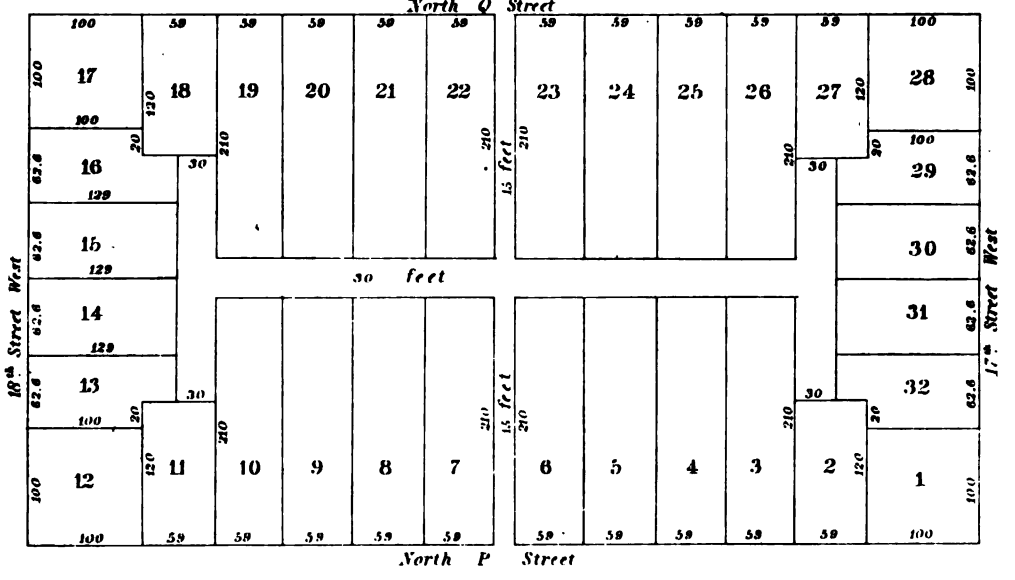



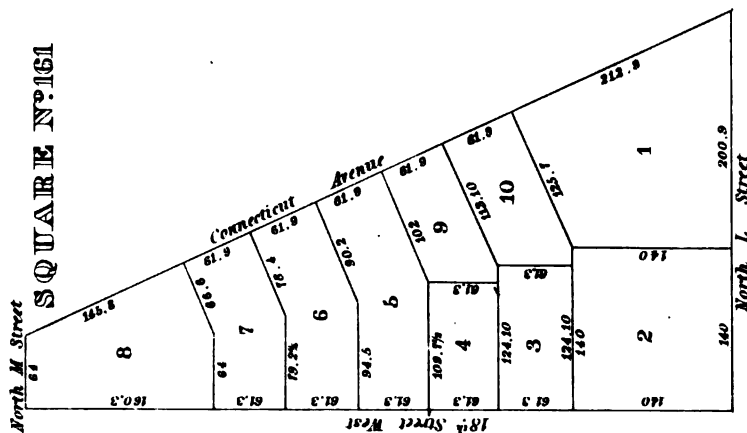
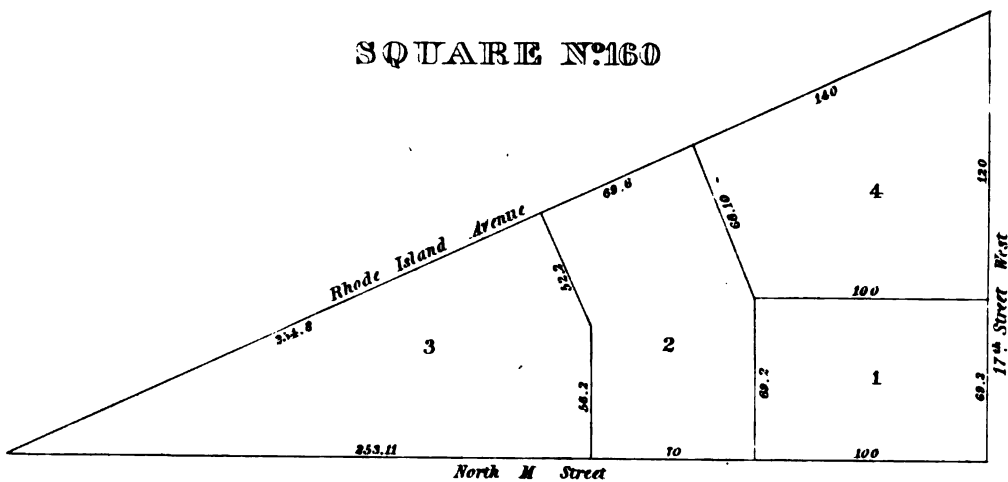
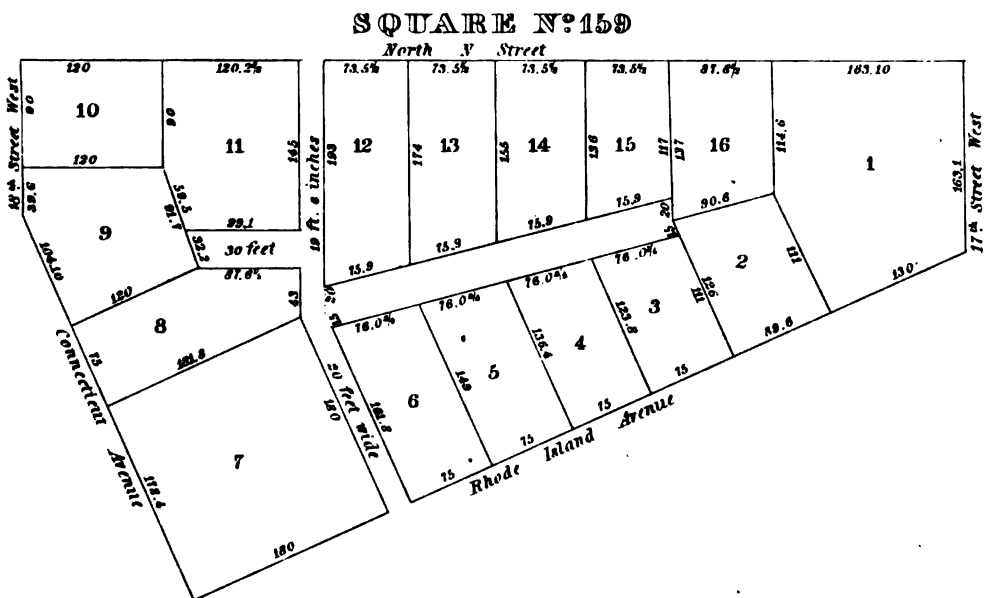
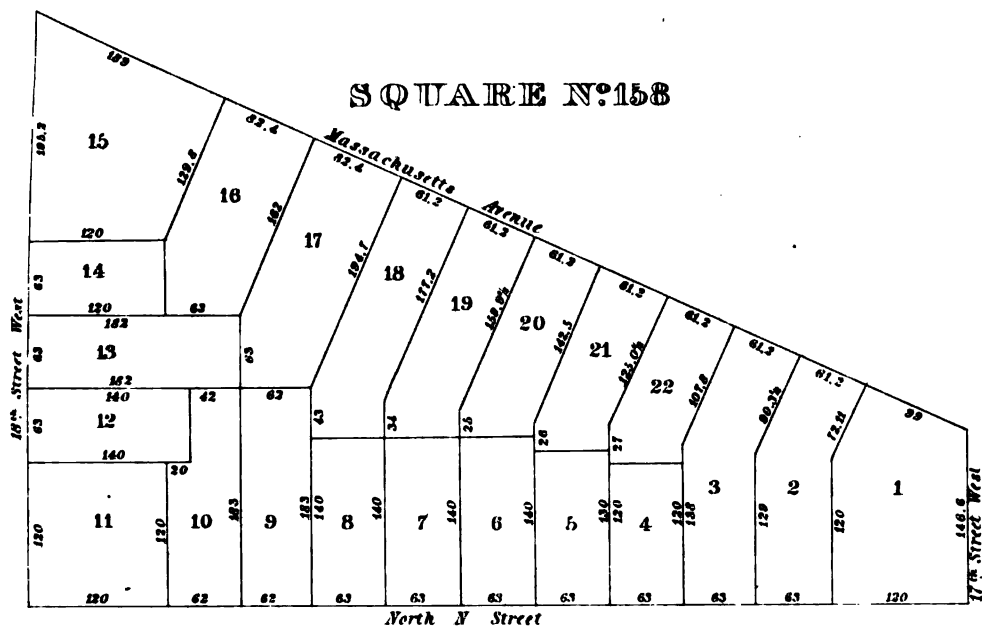





### SQUARE N°162

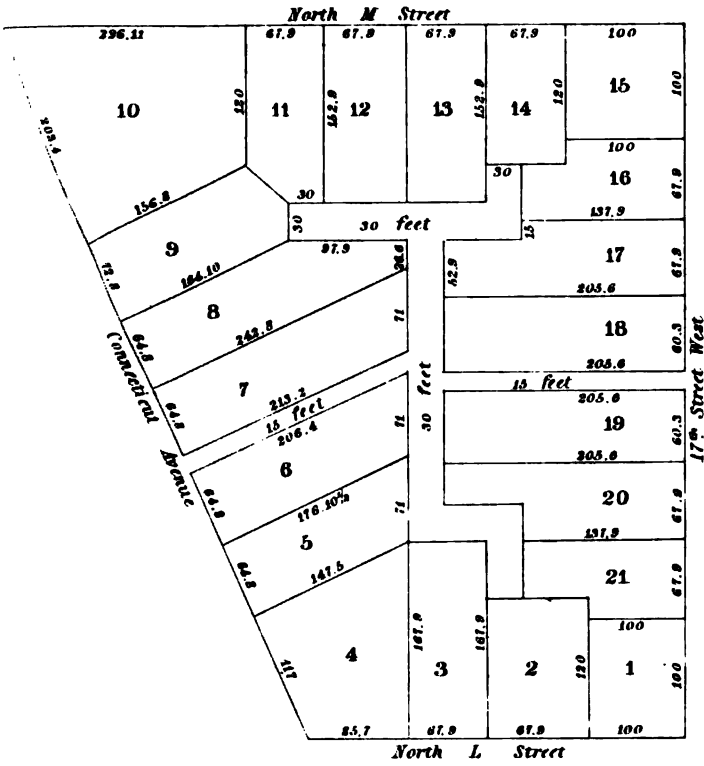

### SQUARE N°164

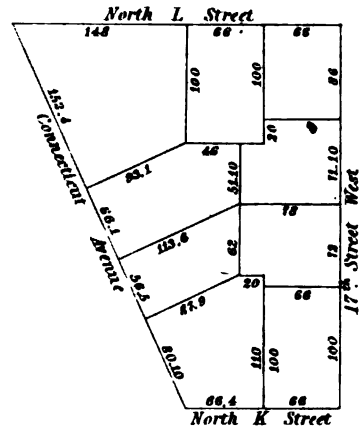

### SQUARE N°163

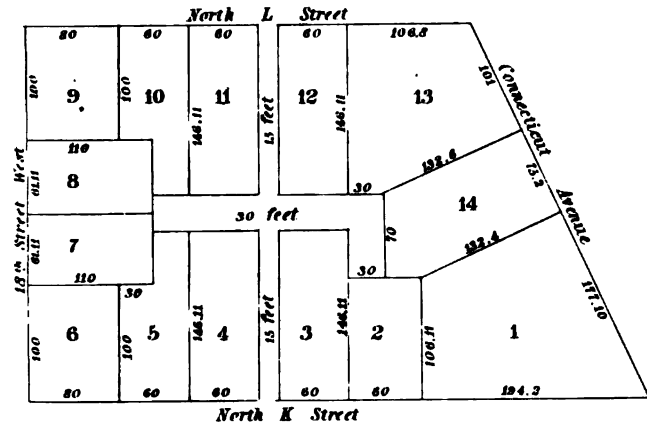

### SQUARE N°167

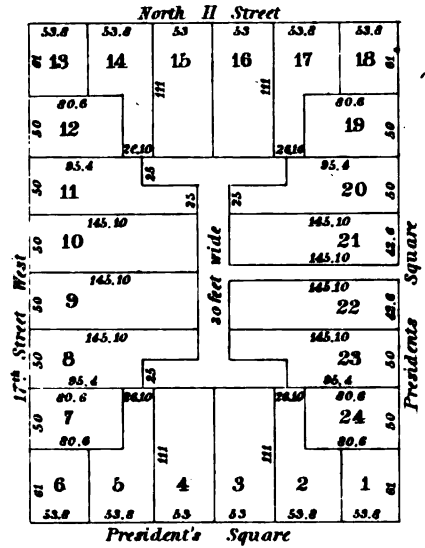

### SQUARE N°165

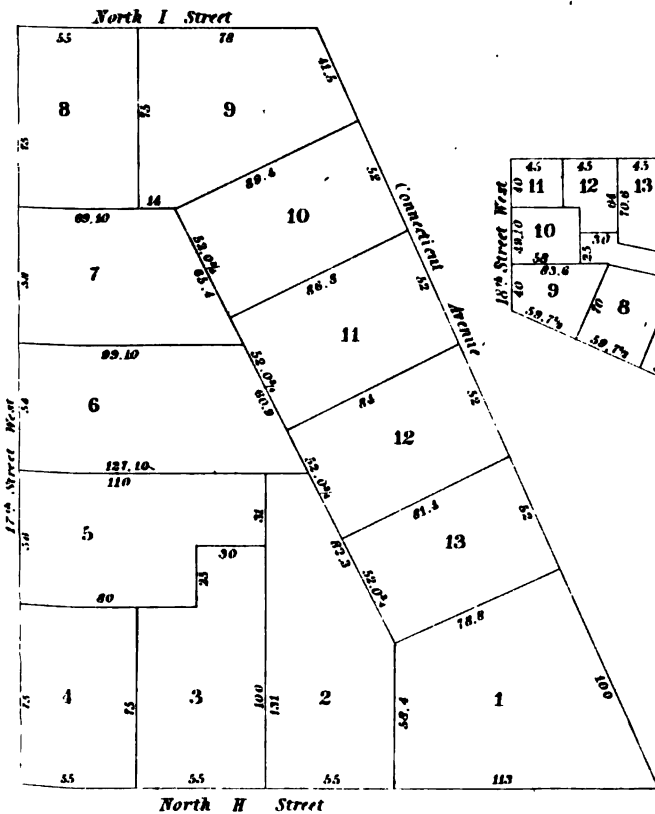

### SQUARE N°166

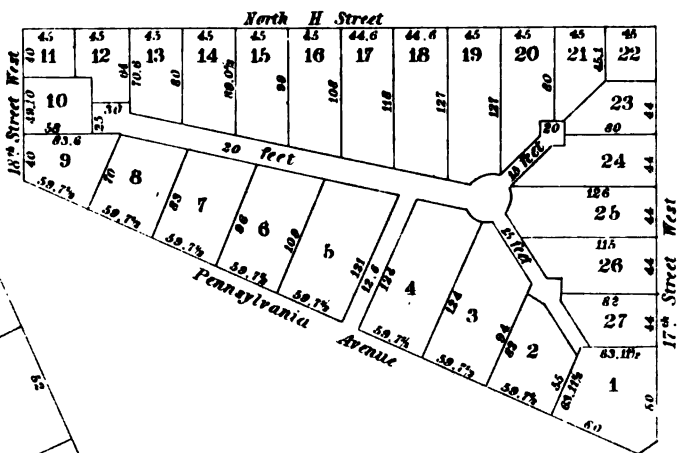



SQUARE N:168

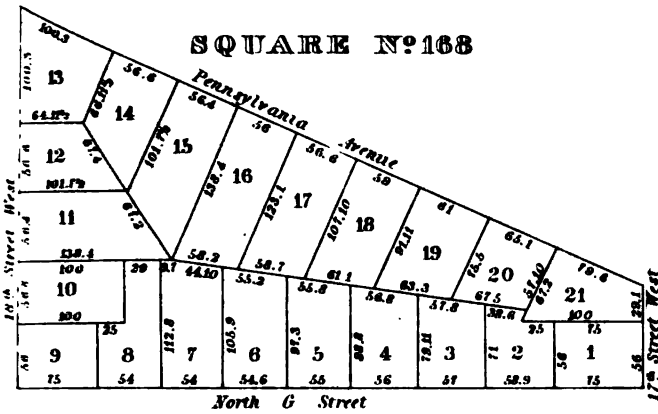

SQUARE N:169

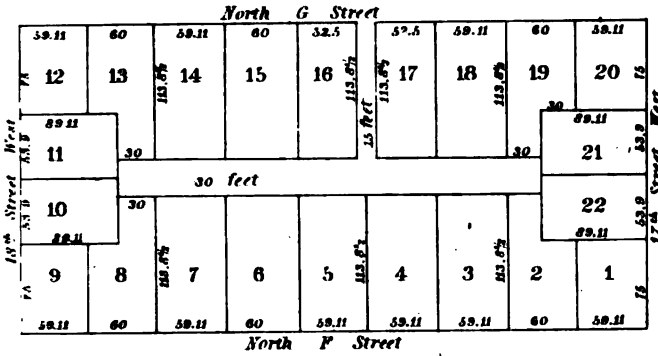

SQUARE N:170

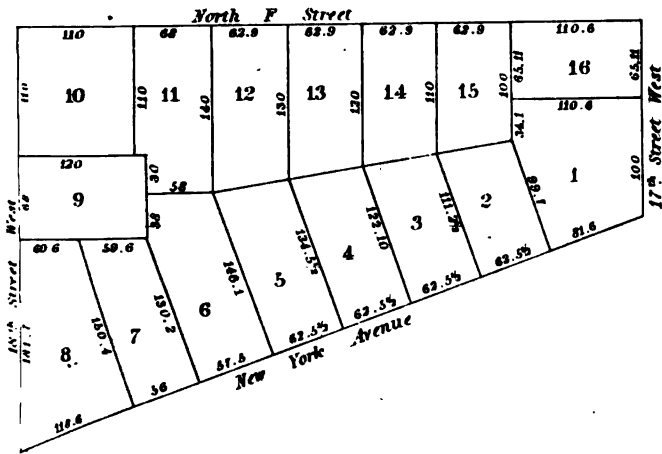

SQUARE N:171

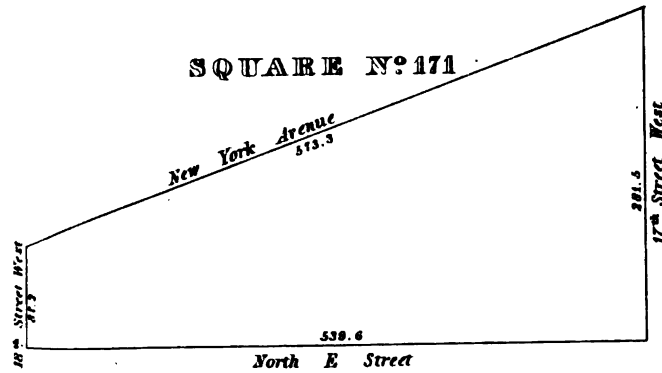

SQUARE N:172

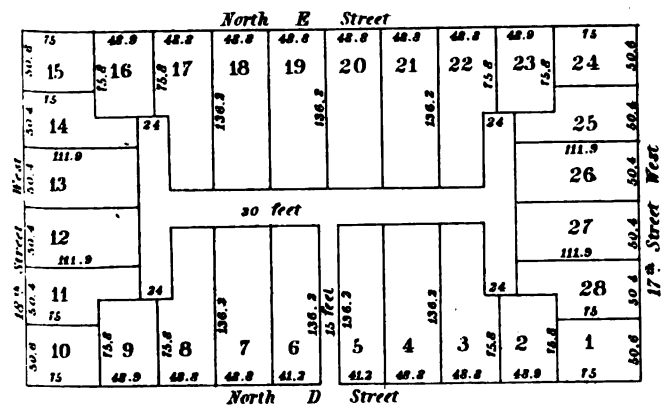

16th Street West

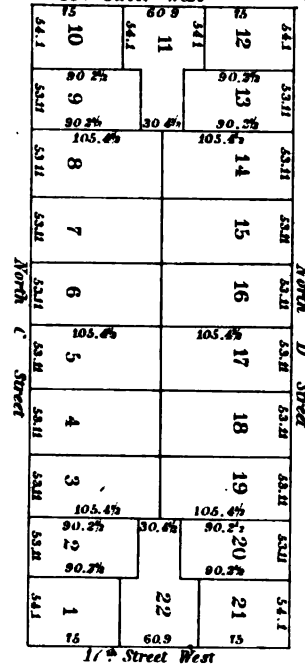

SQUARE N:173

SQUARE S. OF N:173

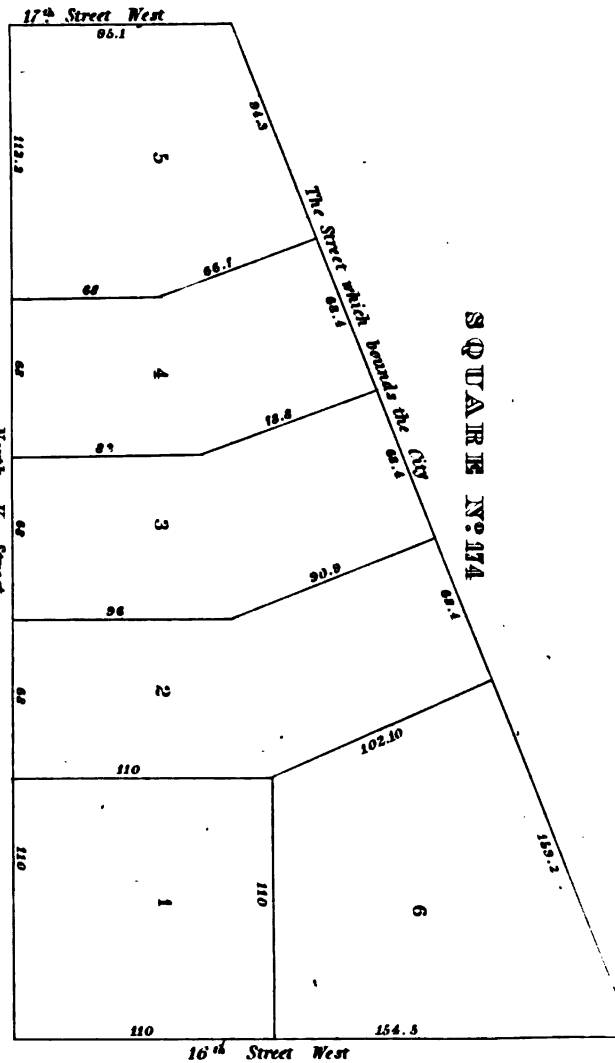
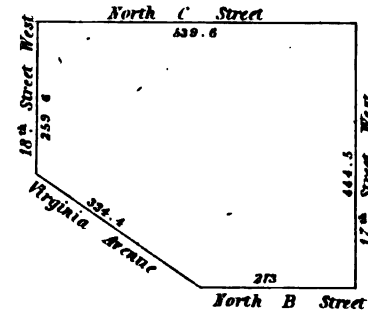

SQUARE N:174



**SQUARE N° 175**

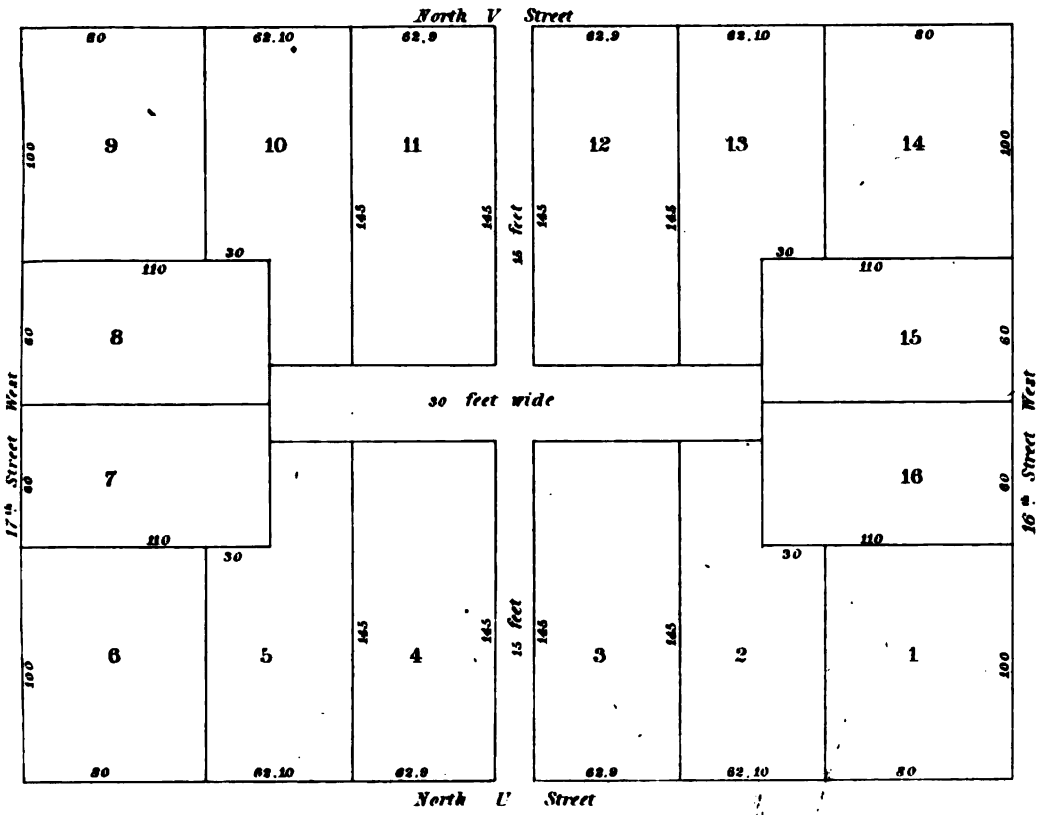

**SQUARE N° 176**

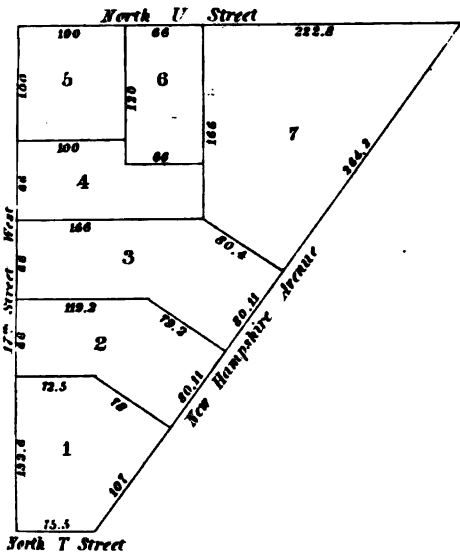

**SQUARE N° 177**

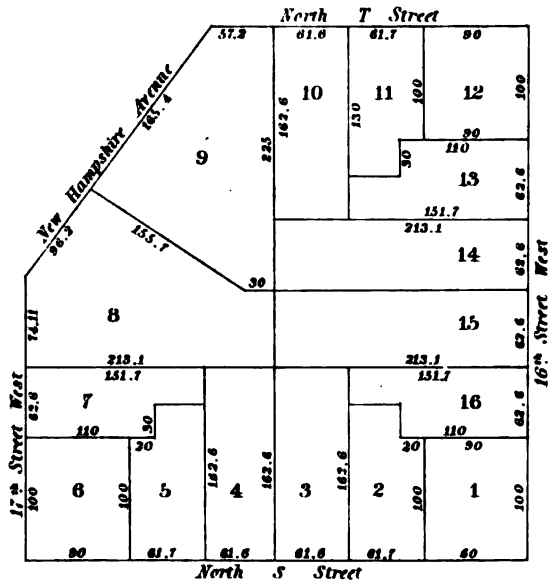

**SQUARE N. OF N° 177**

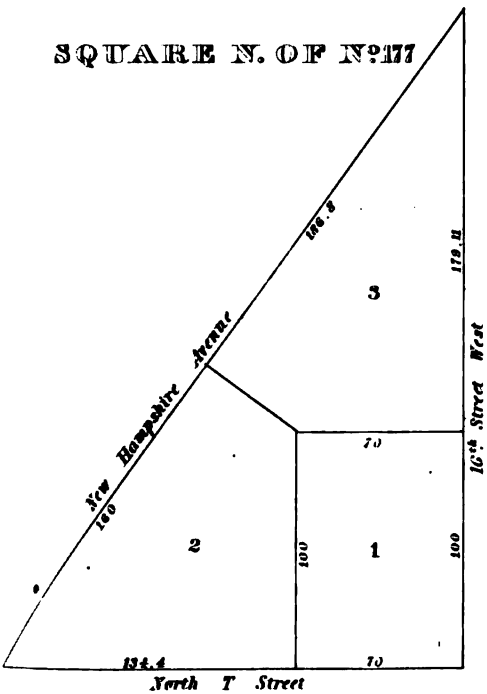

**SQUARE N° 178**

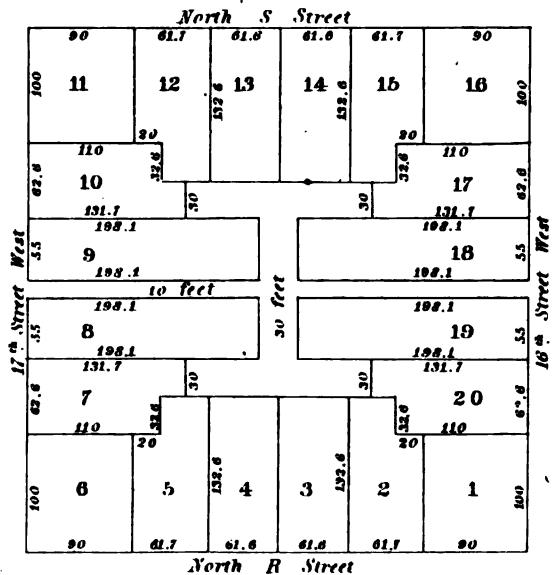



SQUARE N°179

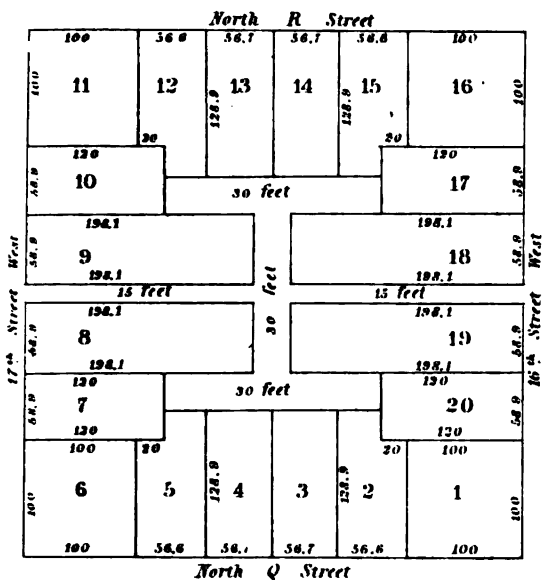

SQUARE N°180

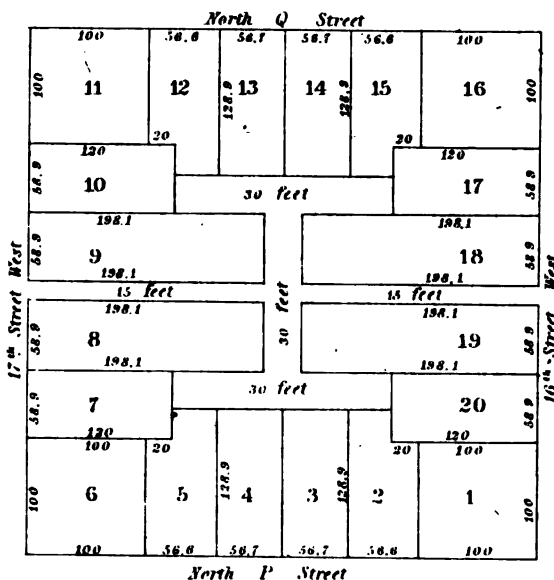

SQUARE S. OF N°181

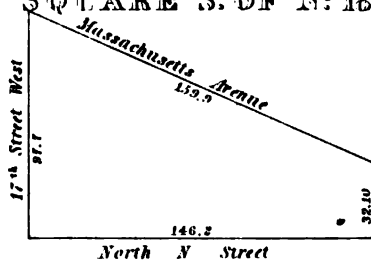

SQUARE N°181

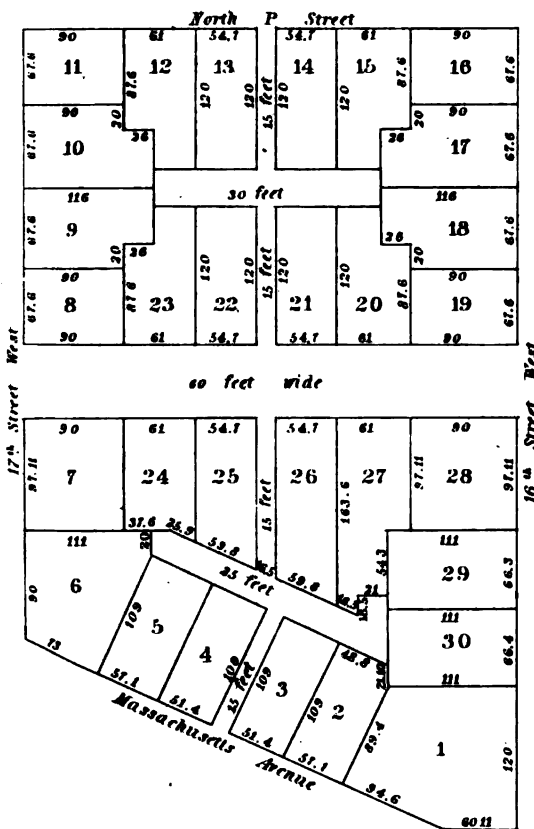

SQUARE N°182

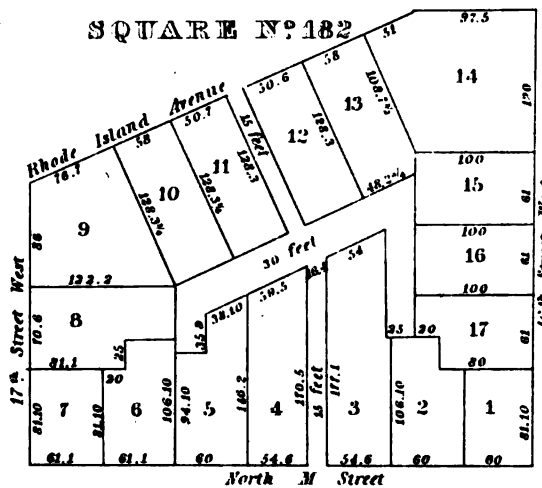

SQUARE N°183

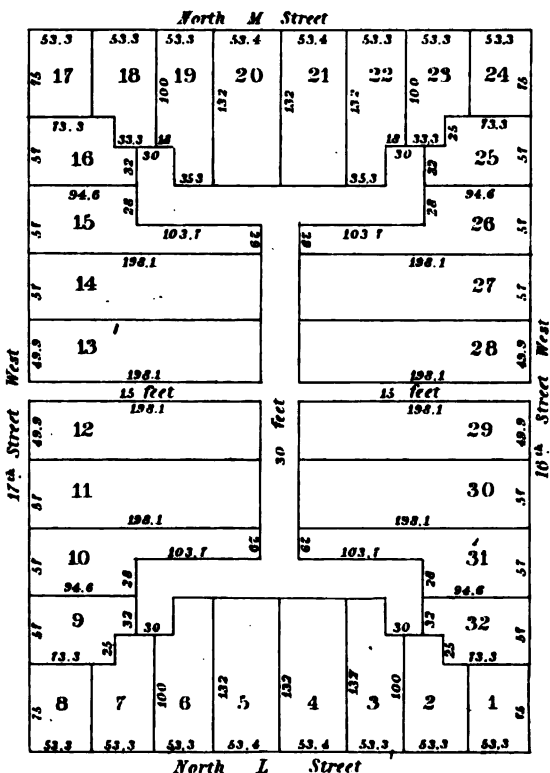

SQUARE N. OF N°182

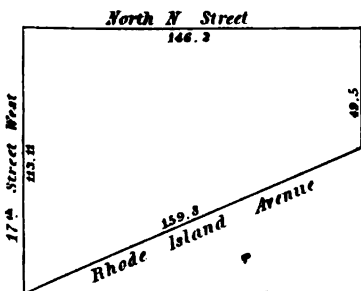





**SQUARE N°170**

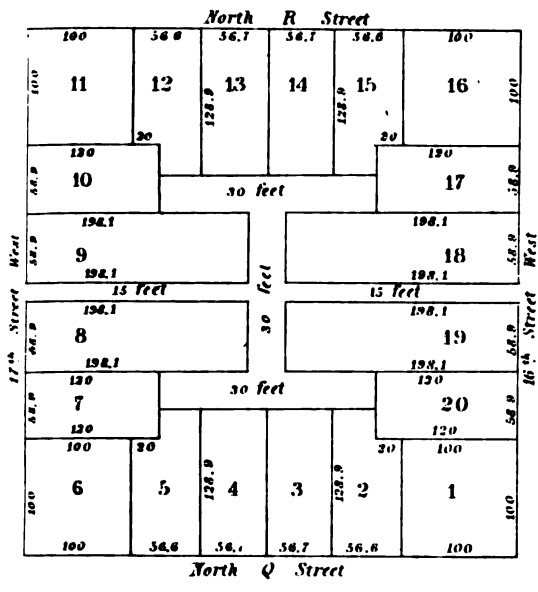

**SQUARE N°180**

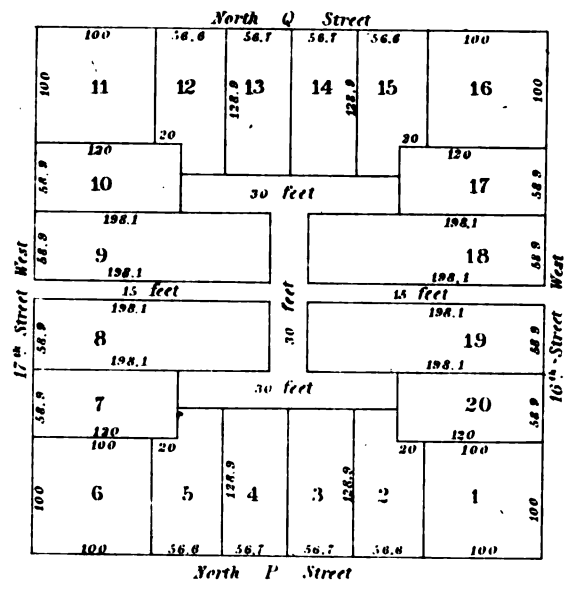

**SQUARE N°181**

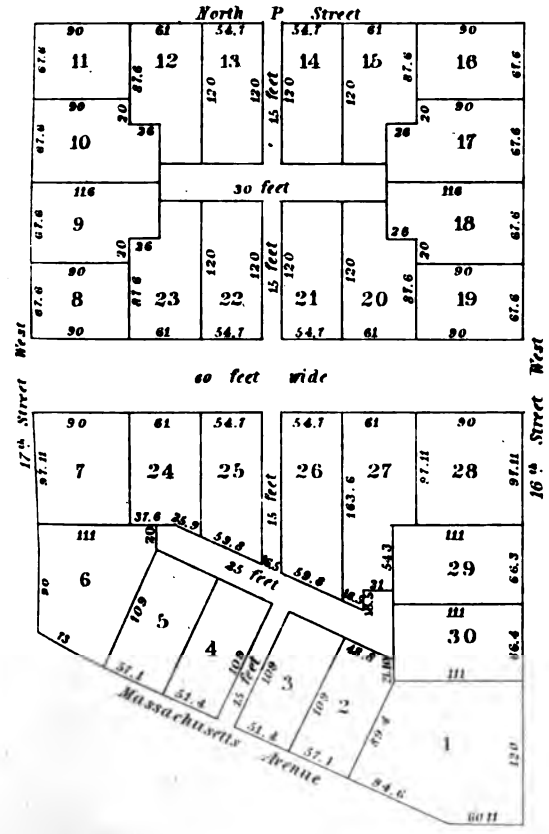

**SQUARE S. OF N°181**

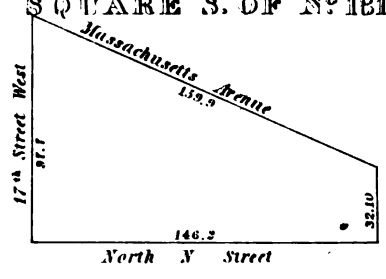

**SQUARE N°182**

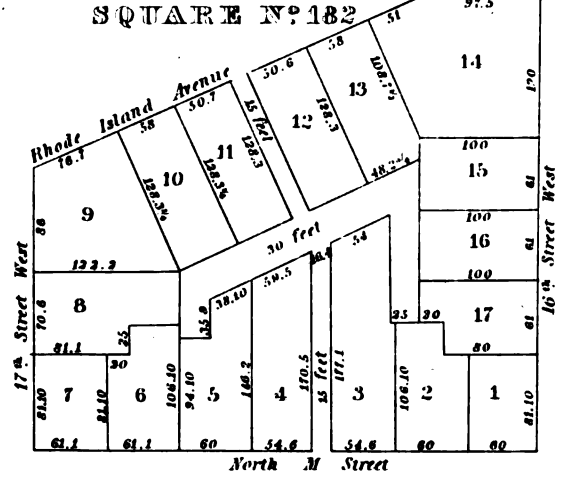

**SQUARE N°183**

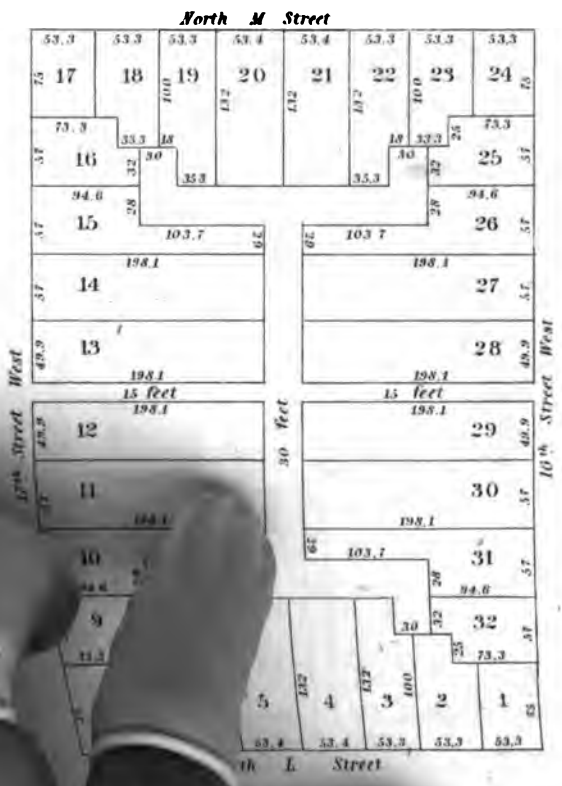

**SQUARE N. OF N°182**





SQUARE N:179

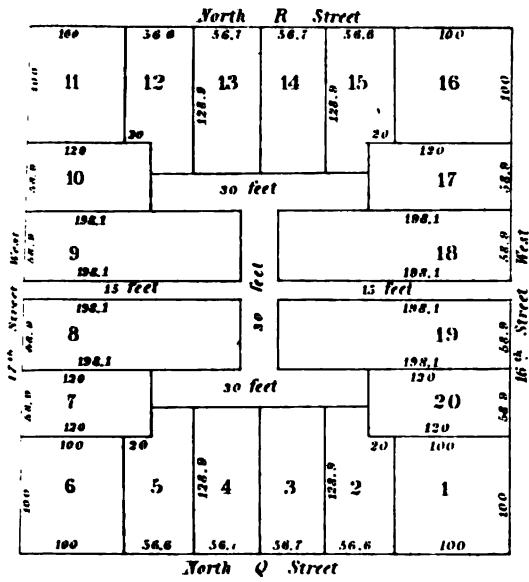

SQUARE N:180

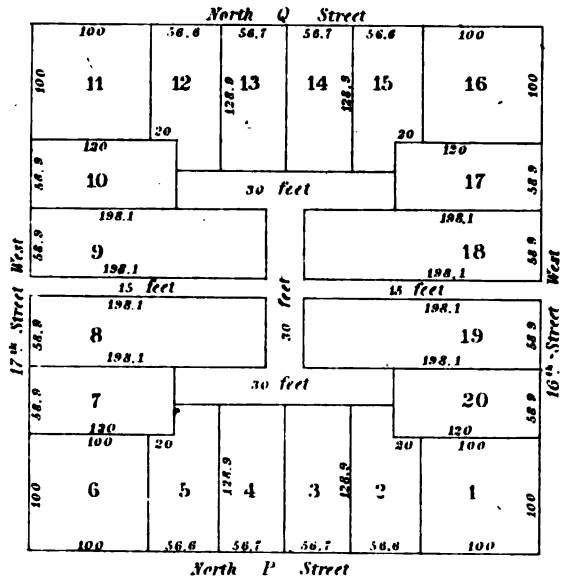

SQUARE N:181

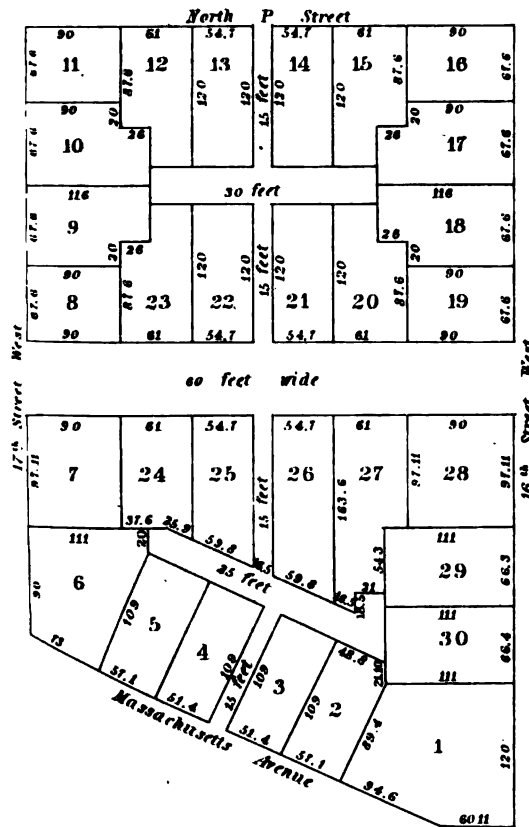

SQUARE S. OF N:181

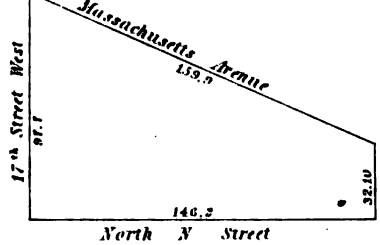

SQUARE N:182

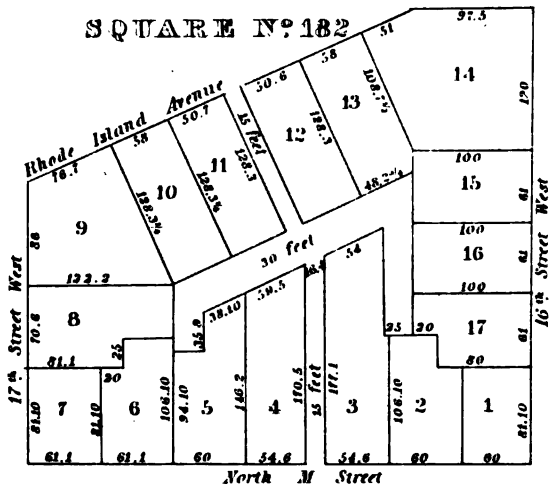

SQUARE N:183

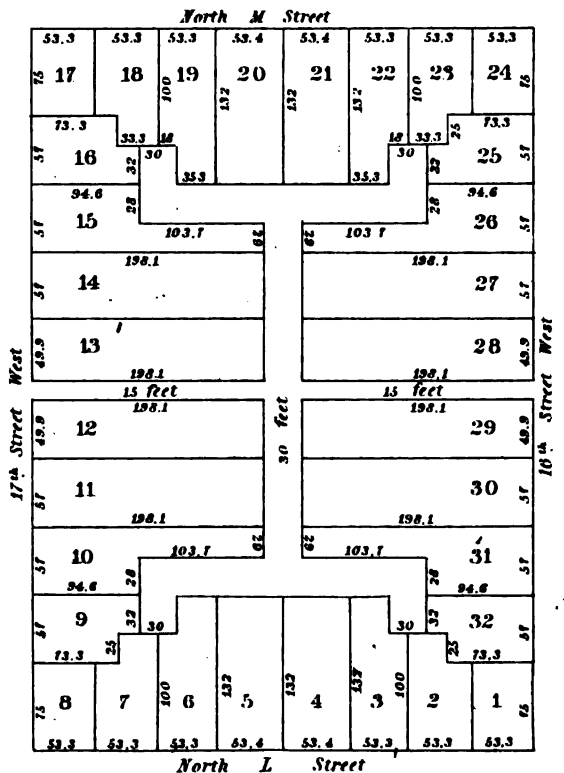

SQUARE N. OF N:182

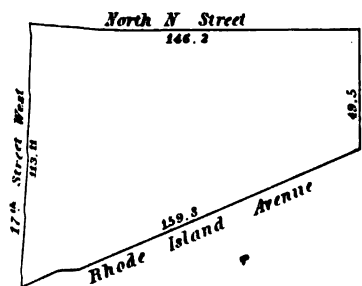



SQUARE N° 184

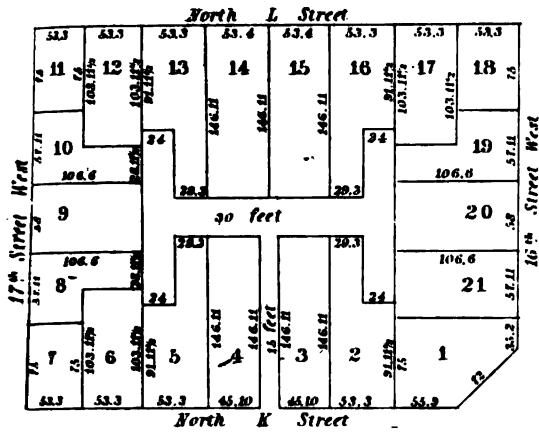

SQUARE N° 185

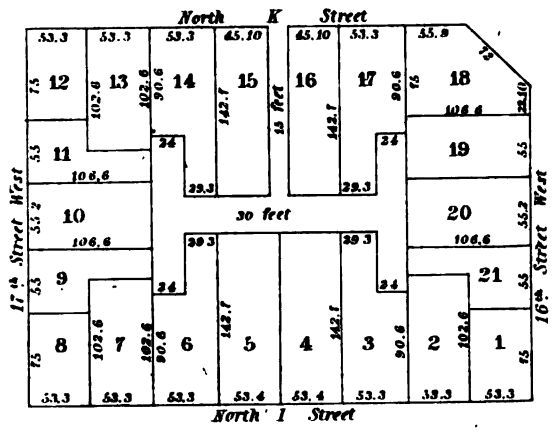

SQUARE N° 186

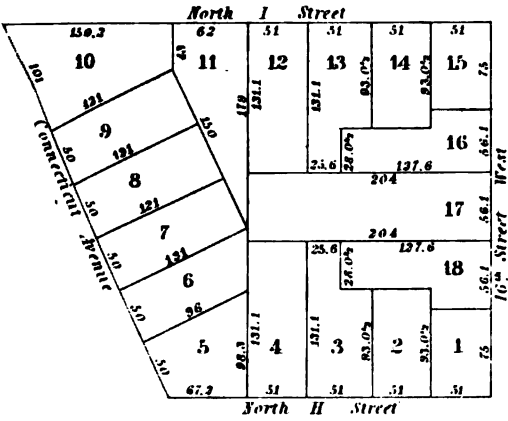

SQUARE N° 188

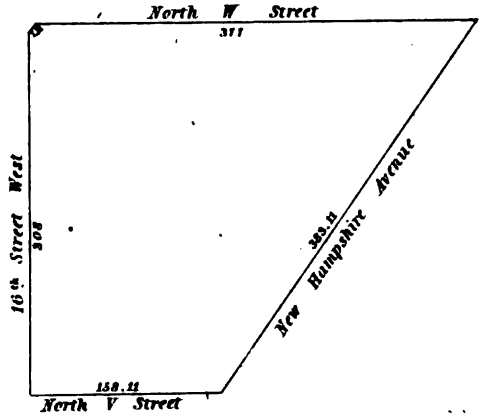

SQUARE S. OF N° 188

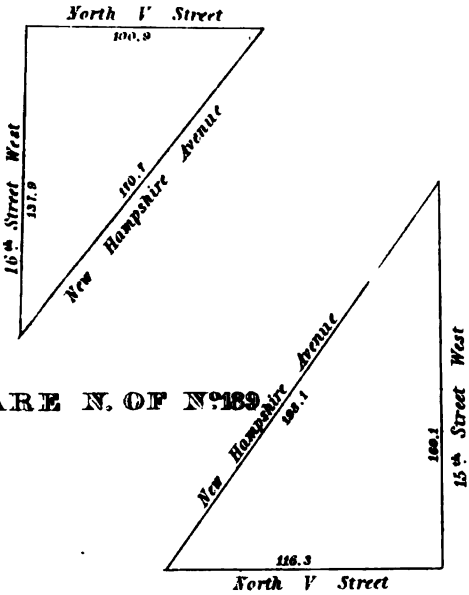

SQUARE N° 189

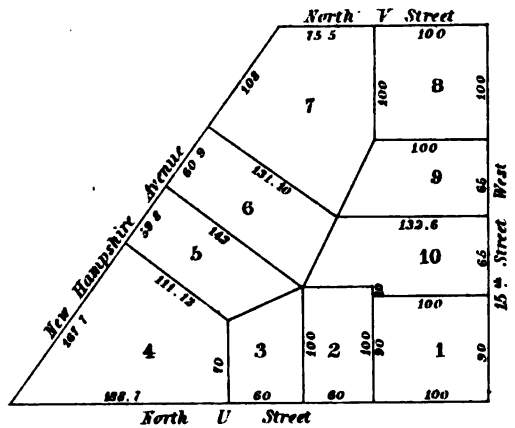

SQUARE N. OF N° 189

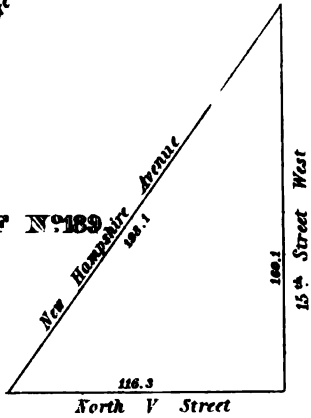

SQUARE N° 191

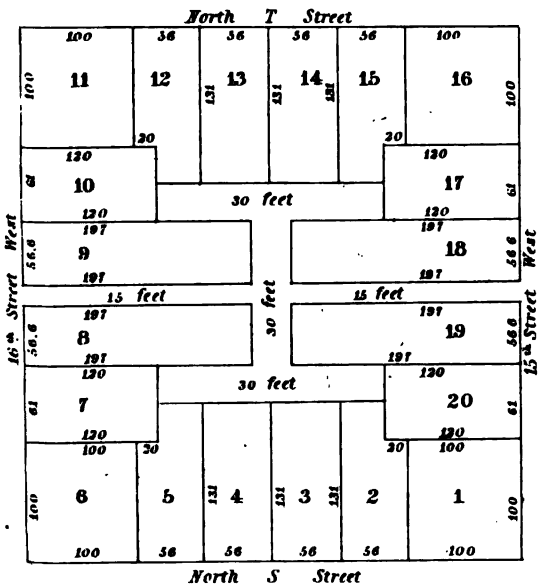

SQUARE N° 190

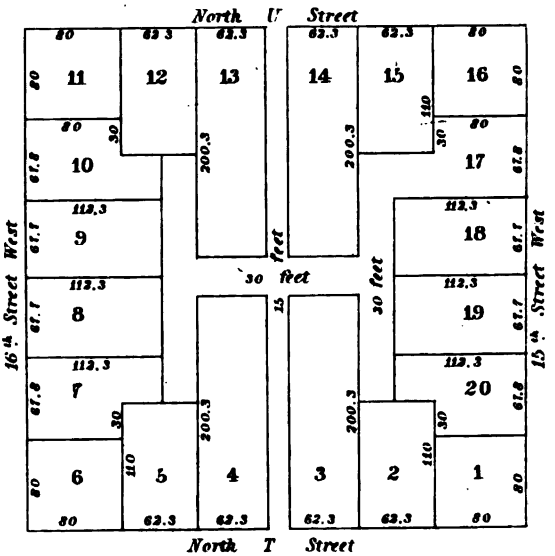



SQUARE N: 192

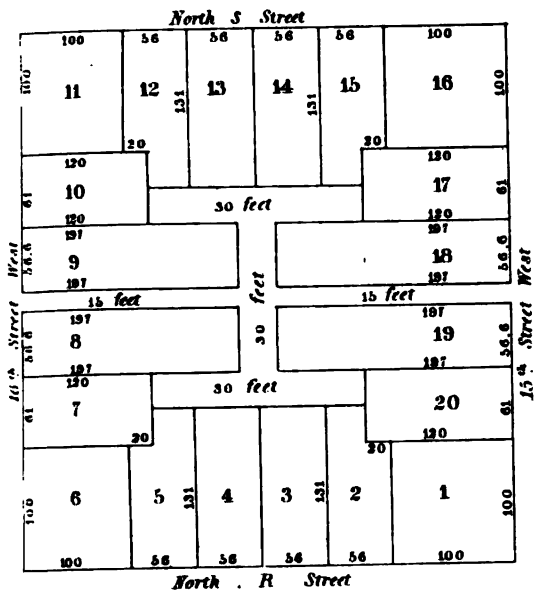

SQUARE N: 193

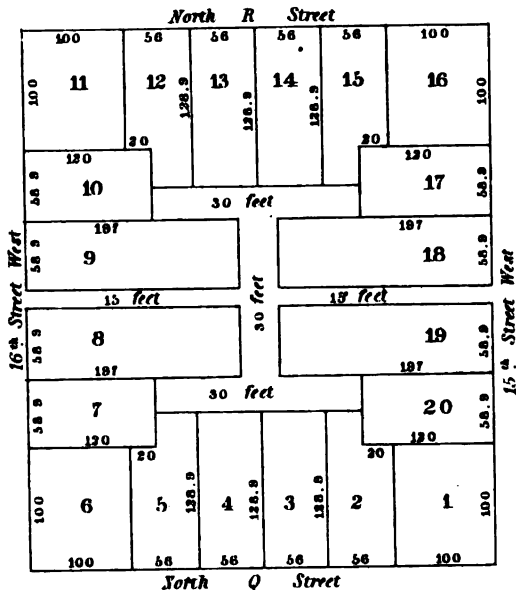

SQUARE N: 194

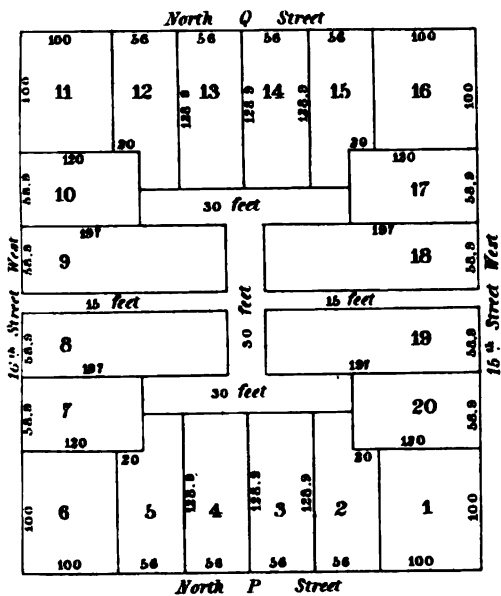

SQUARE N: 195

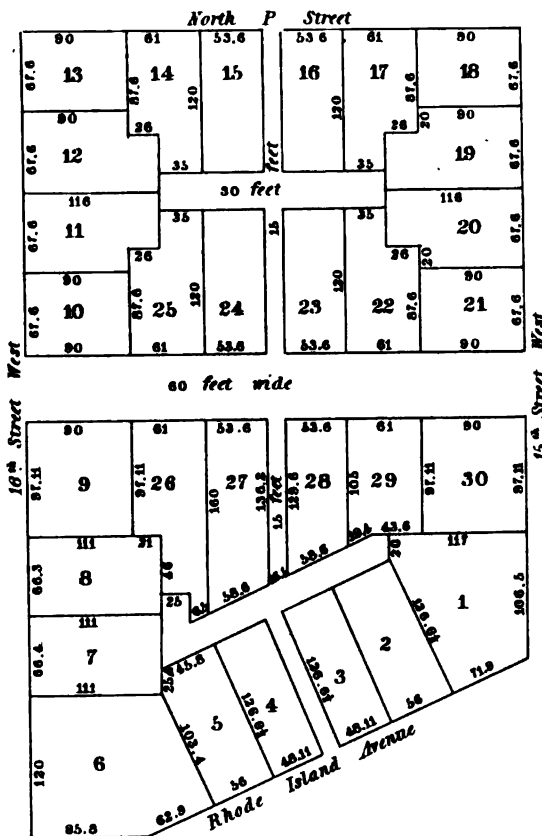

SQUARE S. OF N: 195

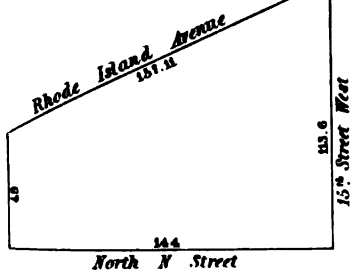

SQUARE N. OF N: 196

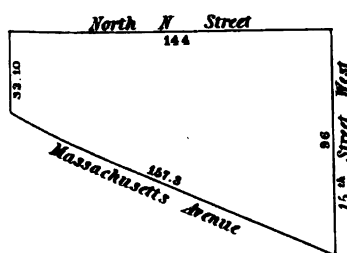

SQUARE N: 196

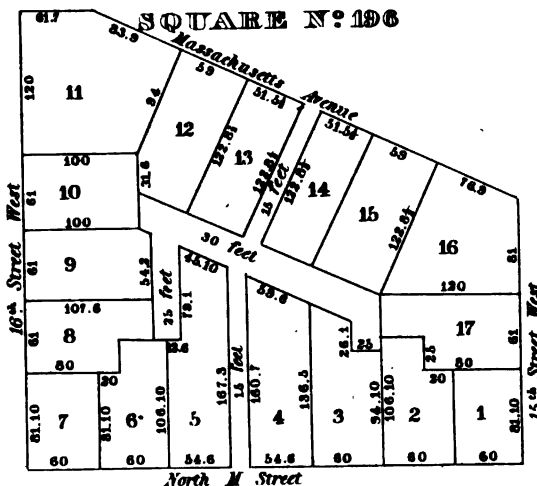





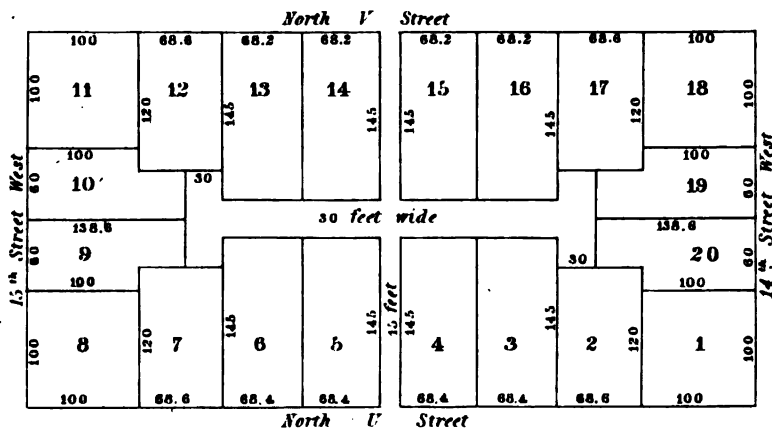
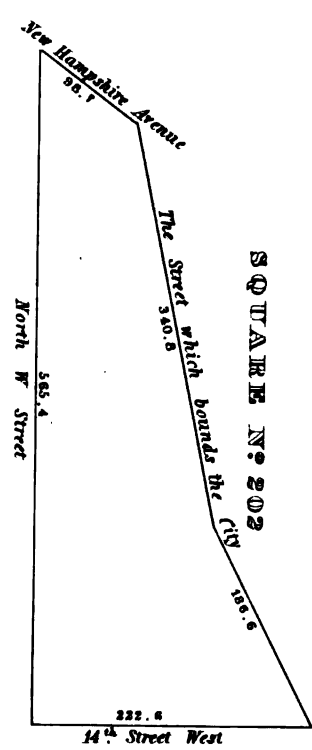
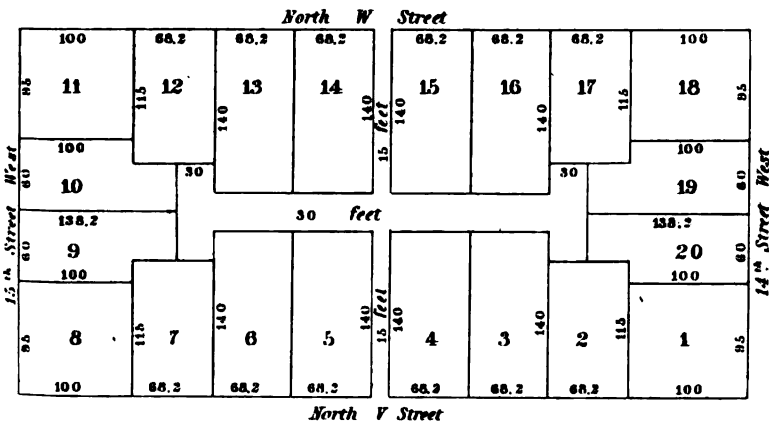
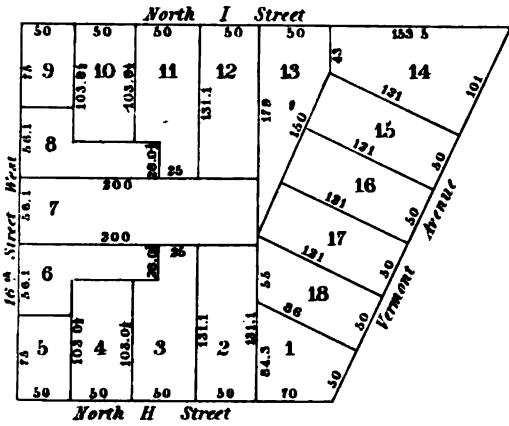
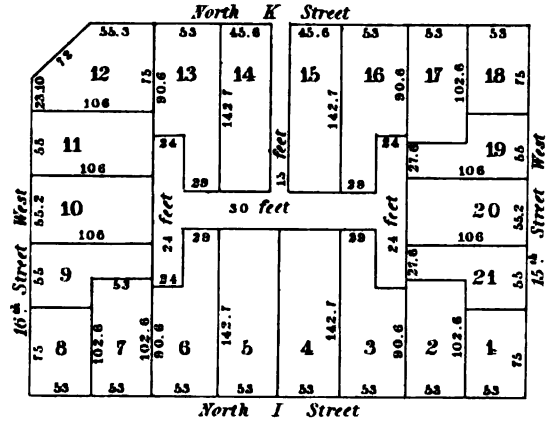
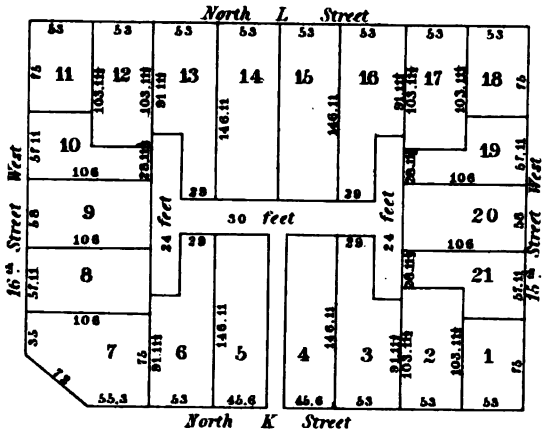
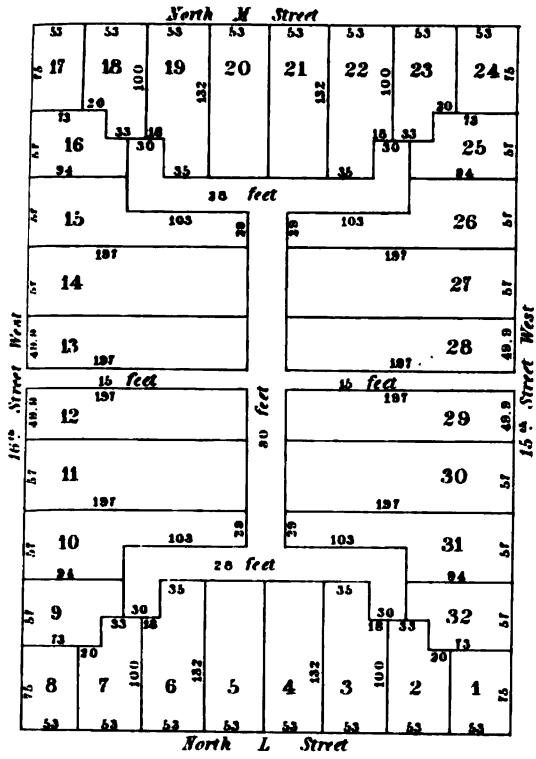



**SQUARE N°170**

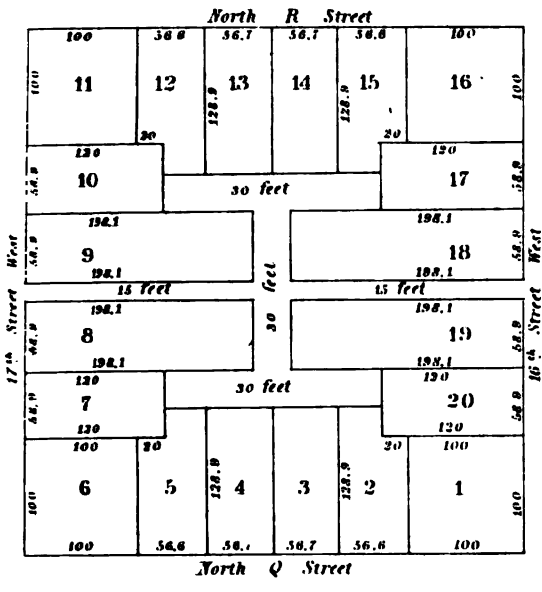

**SQUARE N°180**

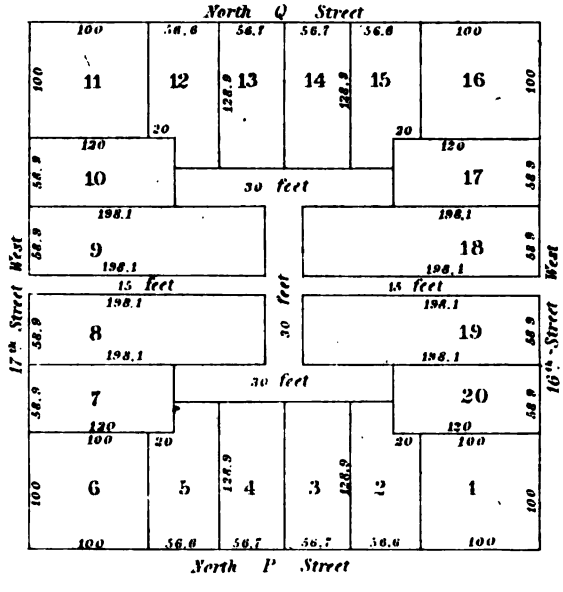

**SQUARE N°181**

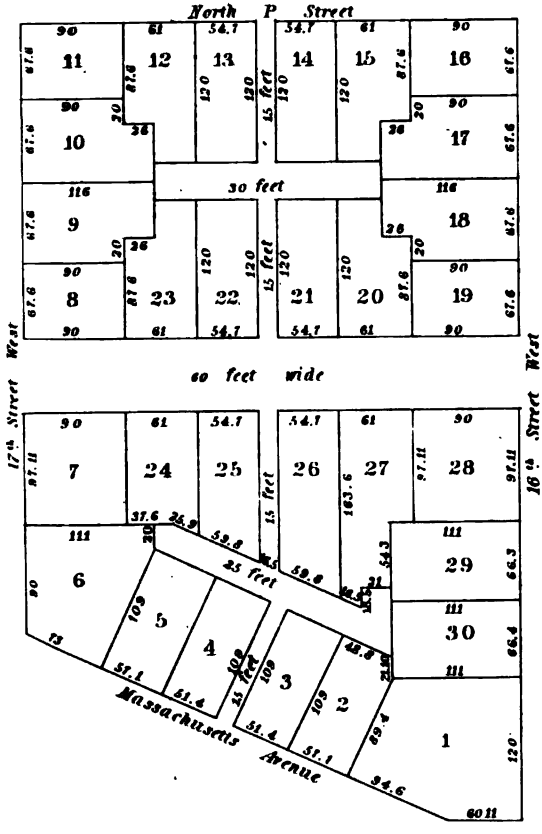

**SQUARE S. OF N°181**

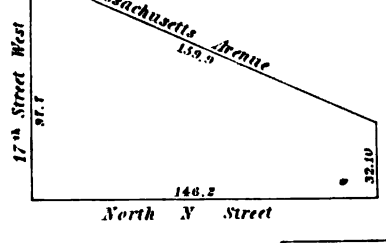

**SQUARE N°182**

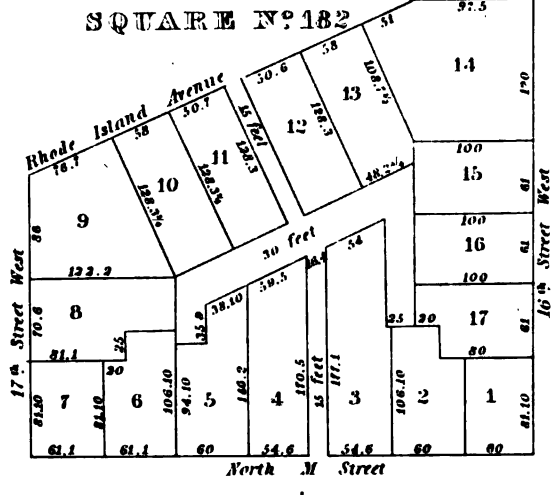

**SQUARE N°183**

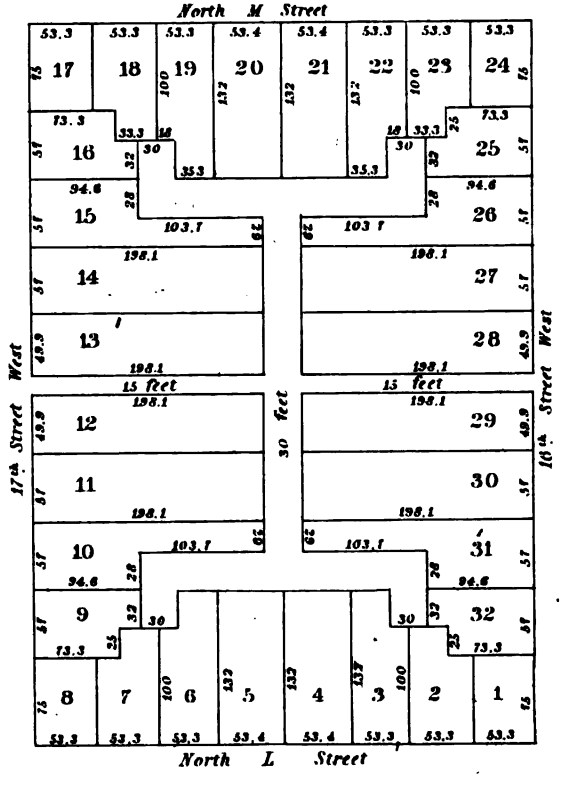

**SQUARE N. OF N°182**

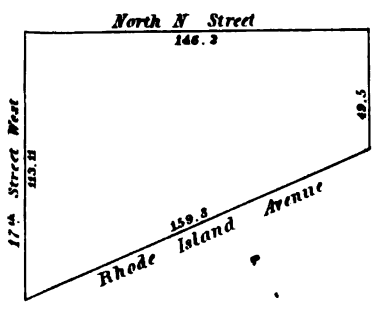



SQUARE N°184

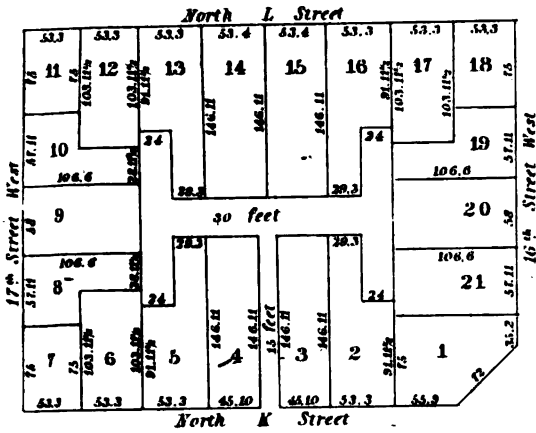

SQUARE N°185

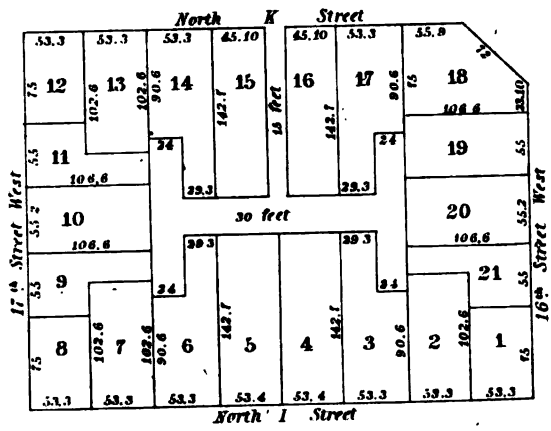

SQUARE N°186

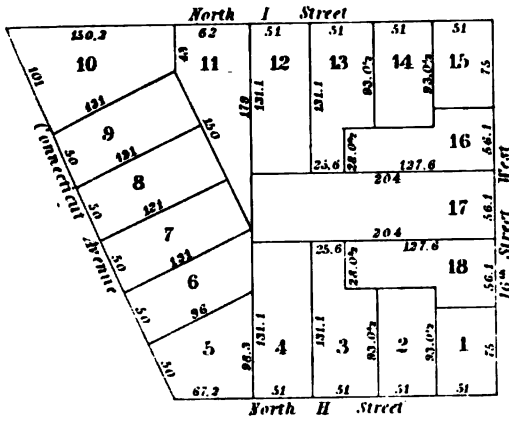

SQUARE N°188

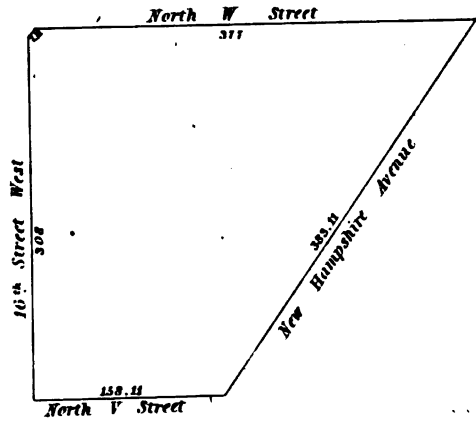

SQUARE S. OF N°188

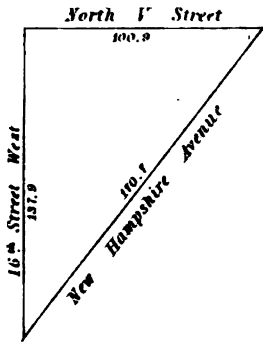

SQUARE N°189

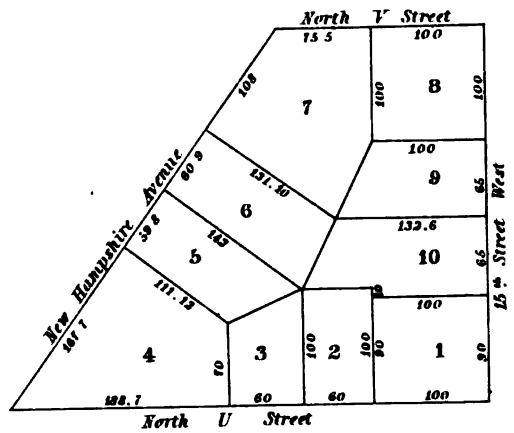

SQUARE N. OF N°189

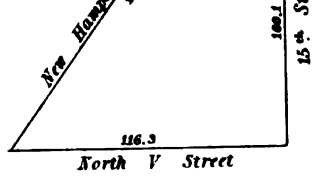

SQUARE N°191

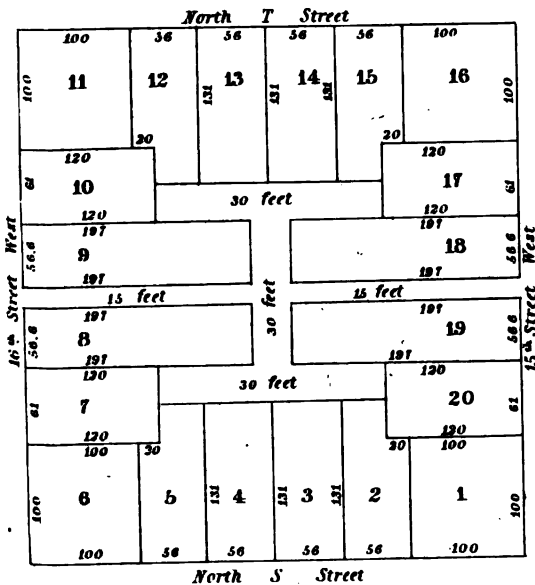

SQUARE N°190

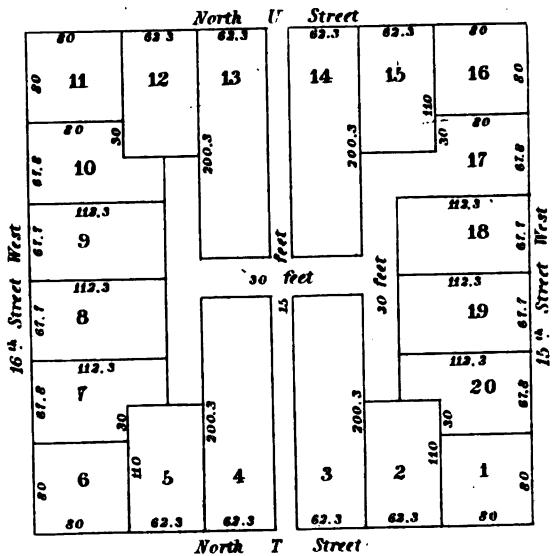



SQUARE N: 192

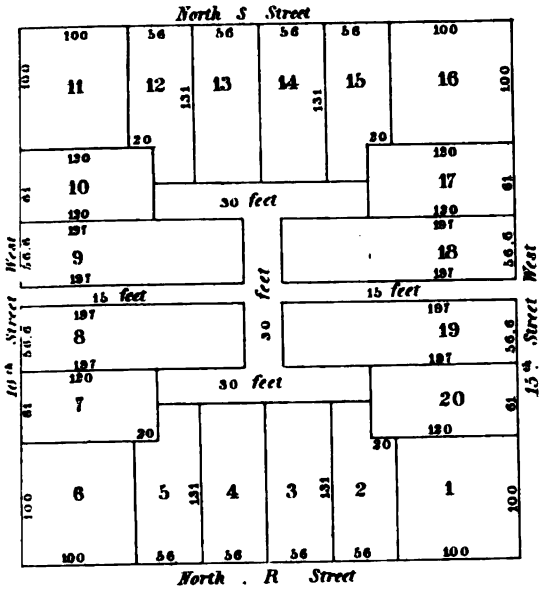

SQUARE N: 193

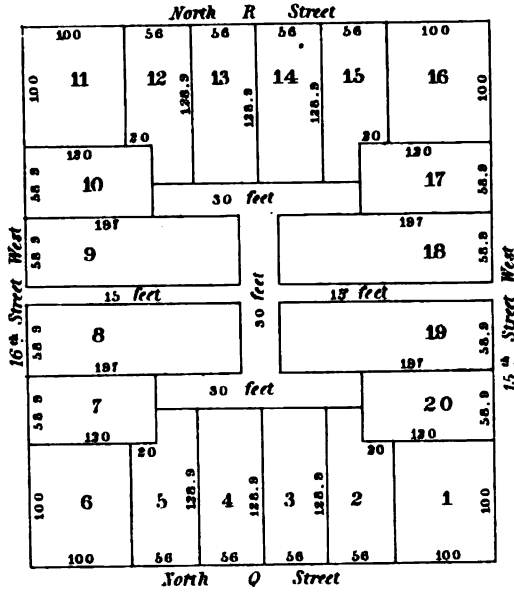

SQUARE N: 194

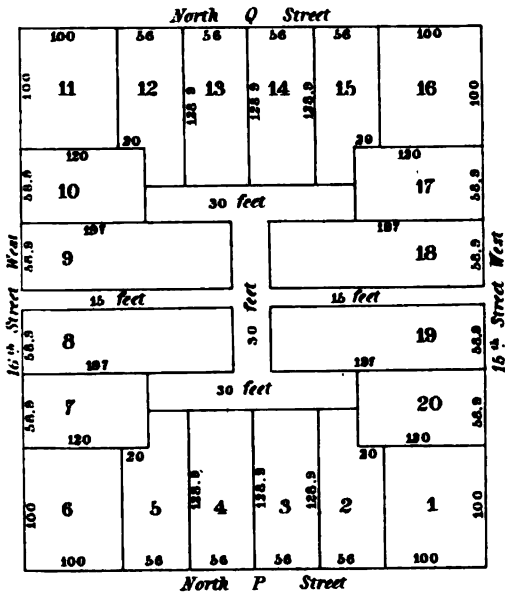

SQUARE N: 195

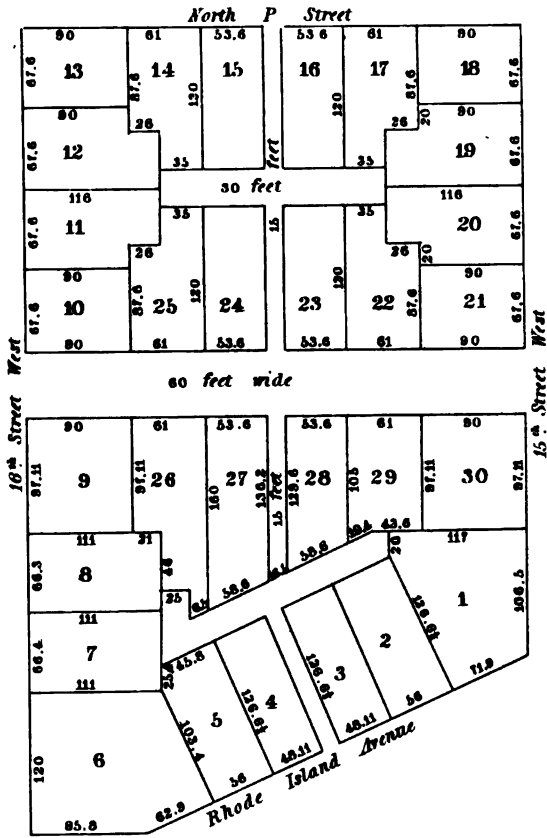

SQUARE S. OF N: 195

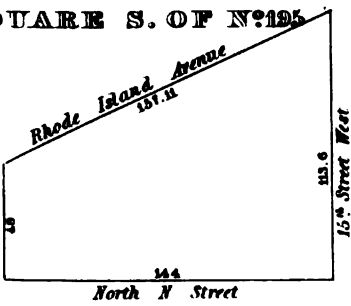

SQUARE N. OF N: 196

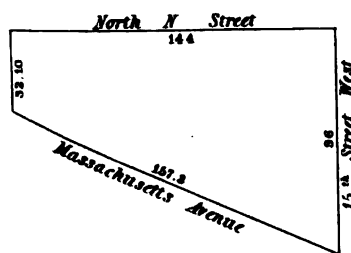

SQUARE N: 196

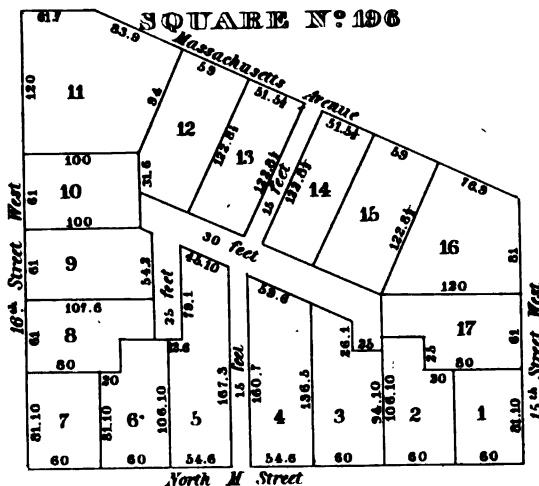





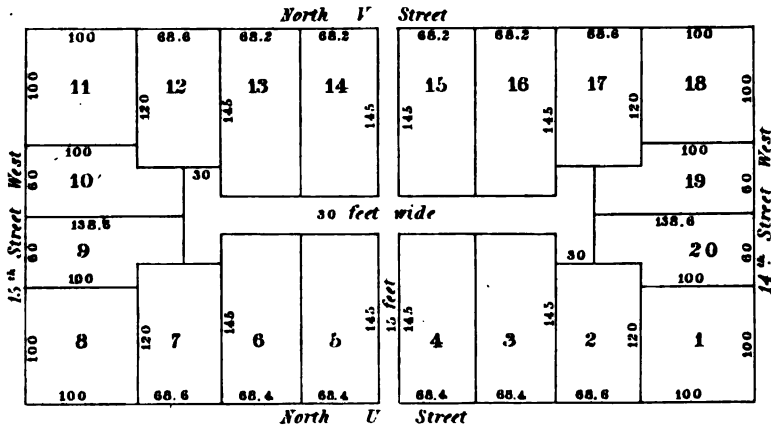
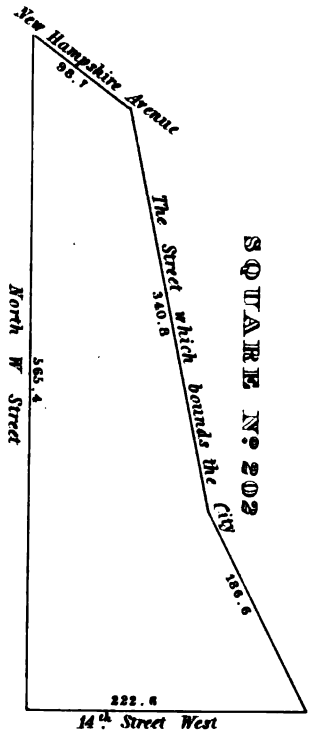
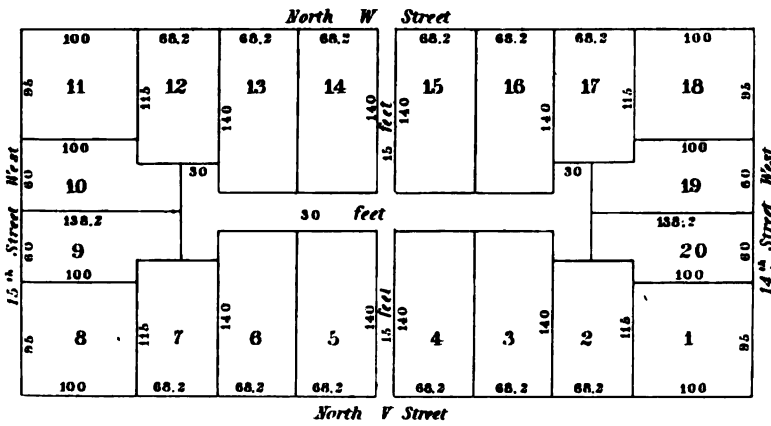
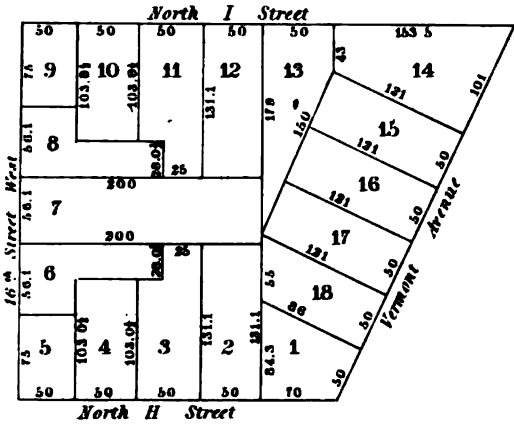
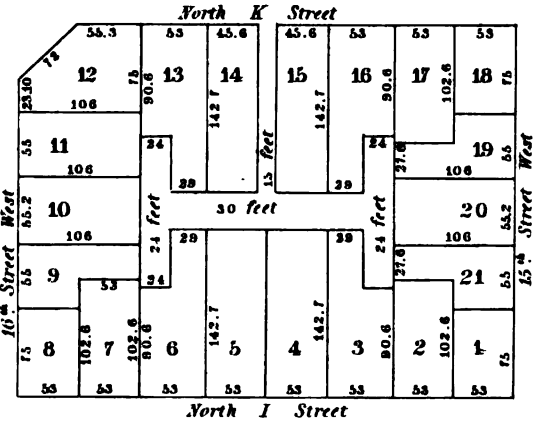
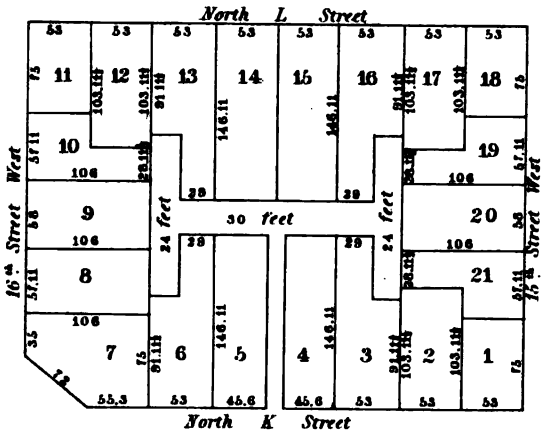
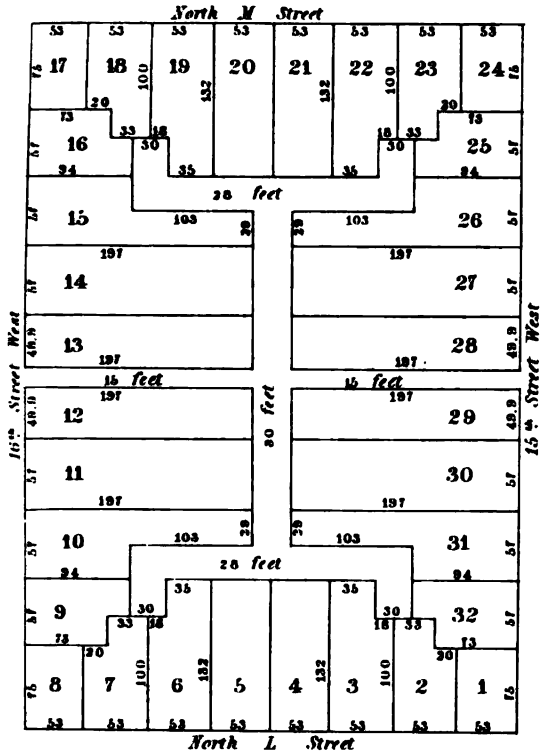



SQUARE N<sup>o</sup> 206

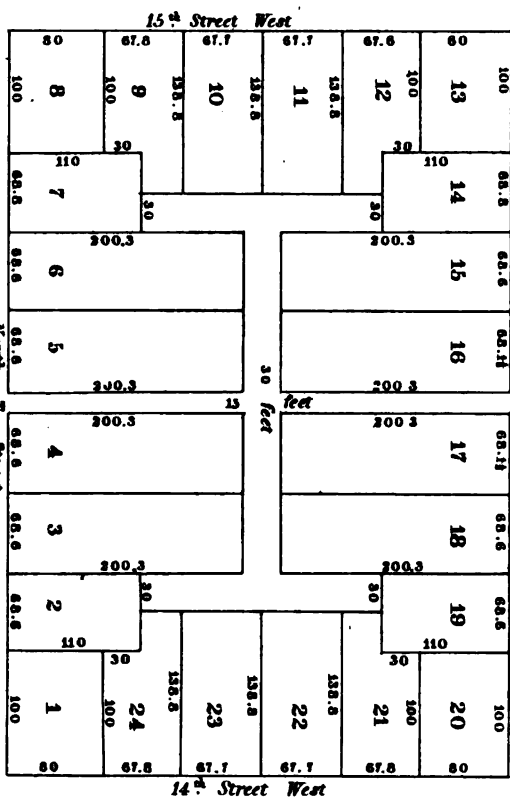

SQUARE N<sup>o</sup> 208

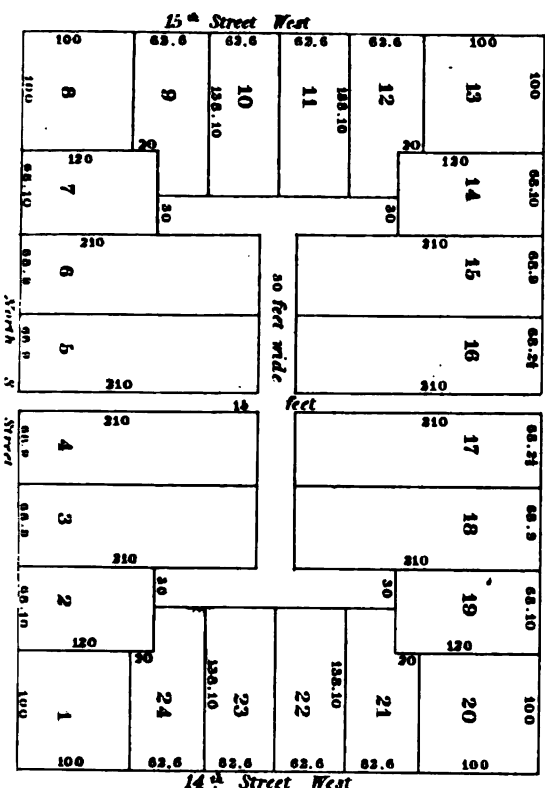

SQUARE N<sup>o</sup> 207

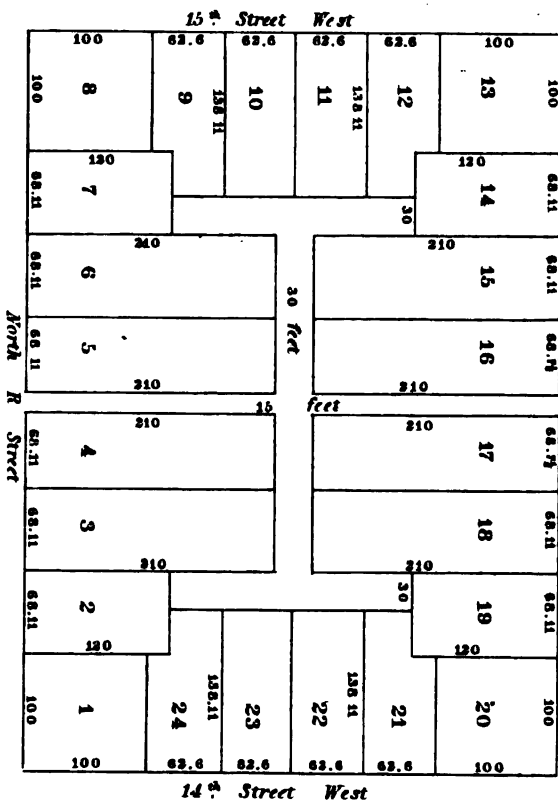

SQUARE N<sup>o</sup> 209

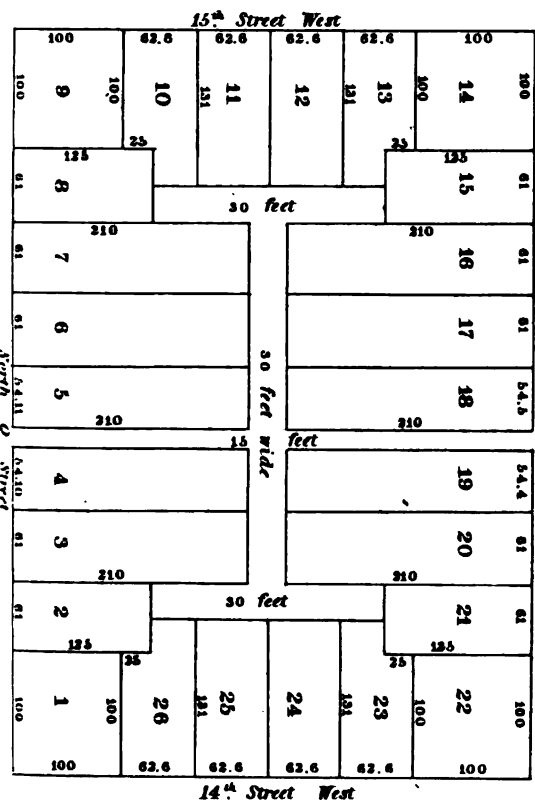

SQUARE N<sup>o</sup> 209

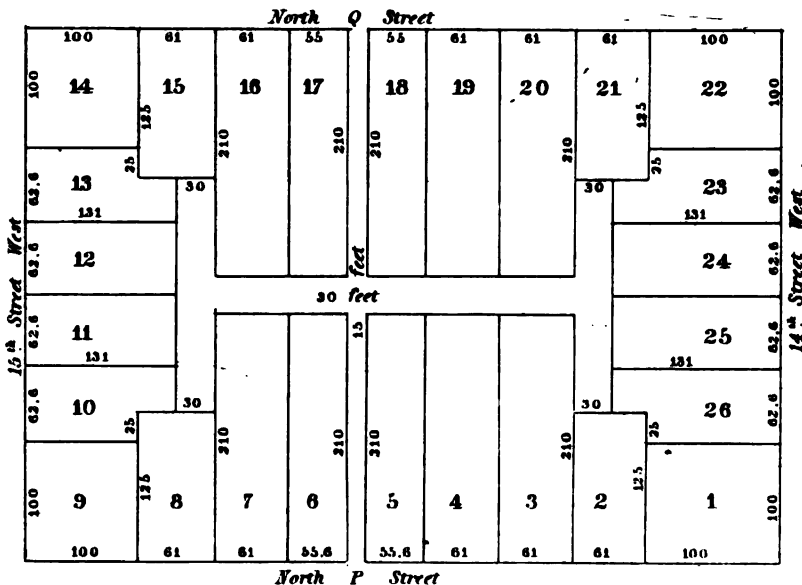



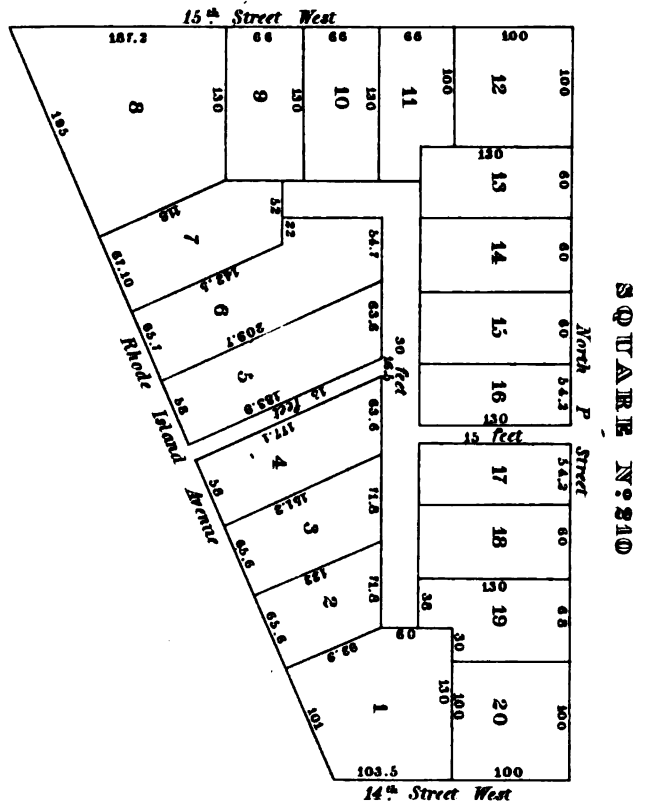
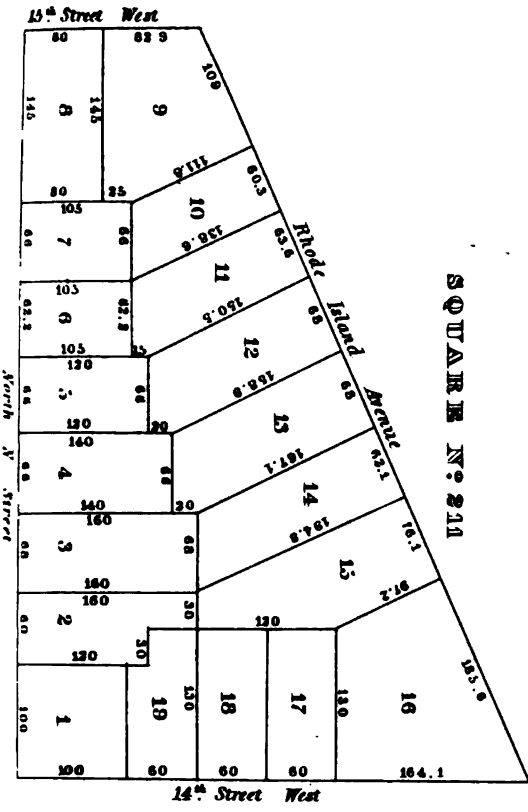

**SQUARE NO. 214**

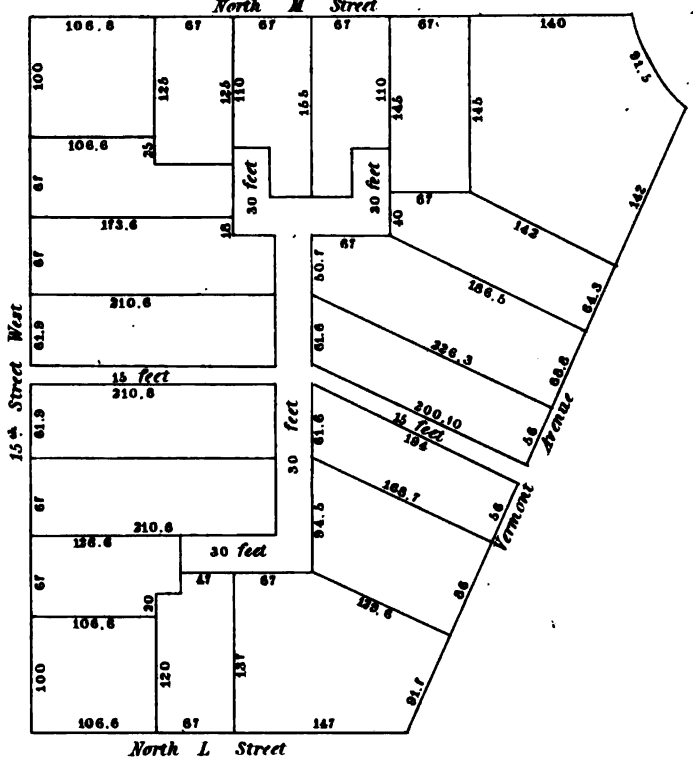
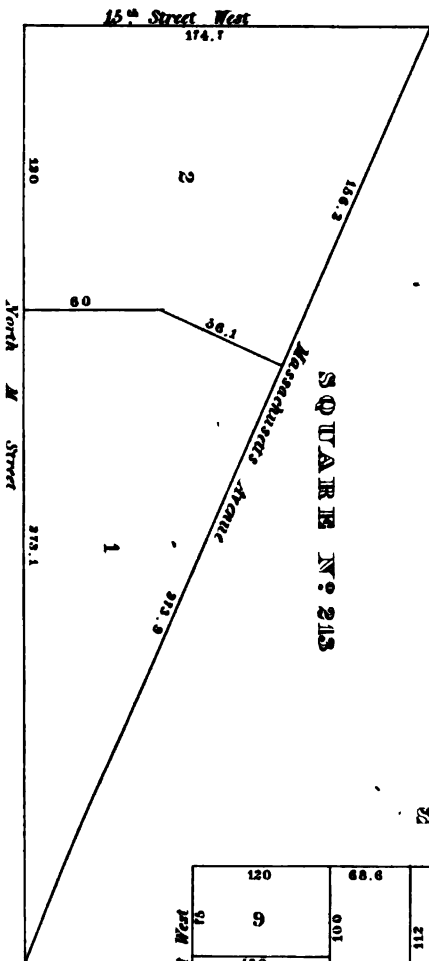

**SQUARE NO. 212**

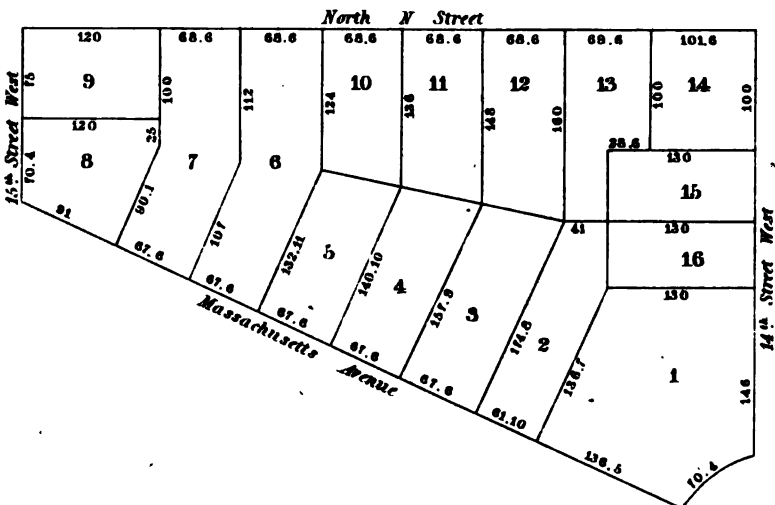



SQUARE N: 216

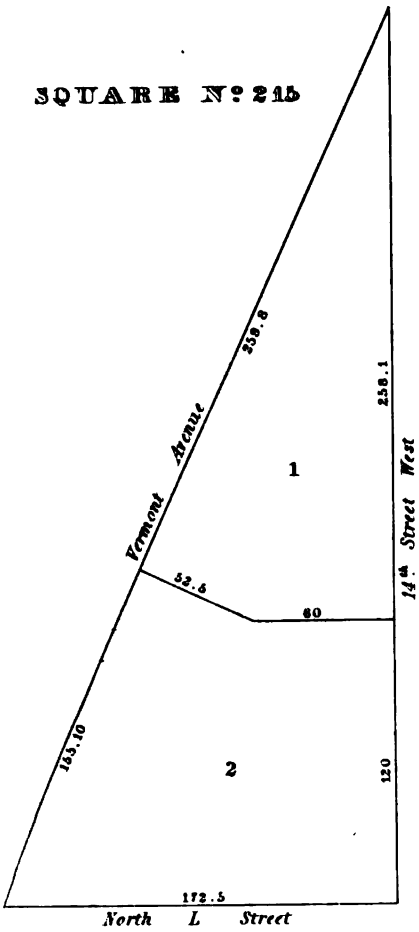

SQUARE N: 218

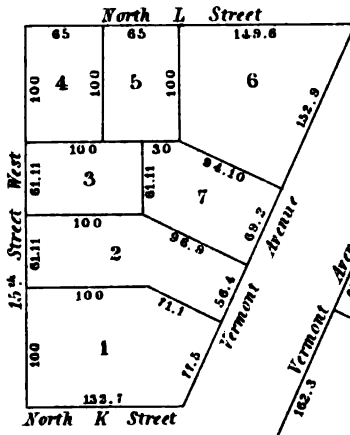

SQUARE N: 217

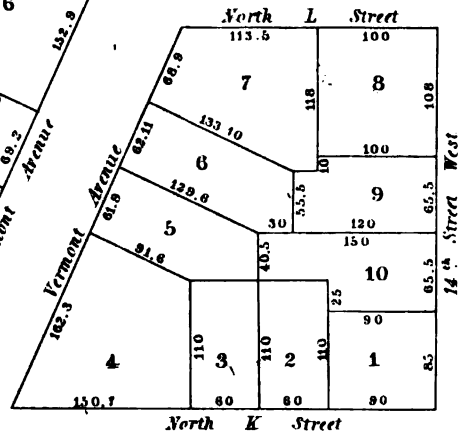

SQUARE N: 218

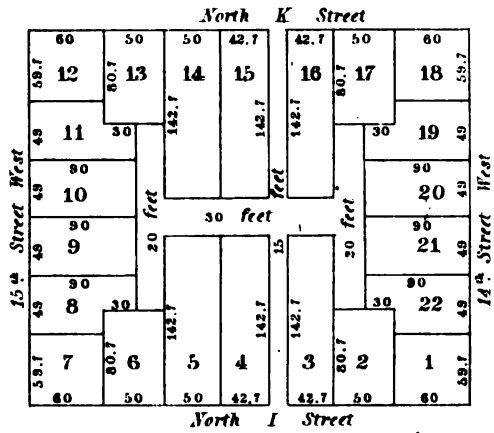

SQUARE N: 219

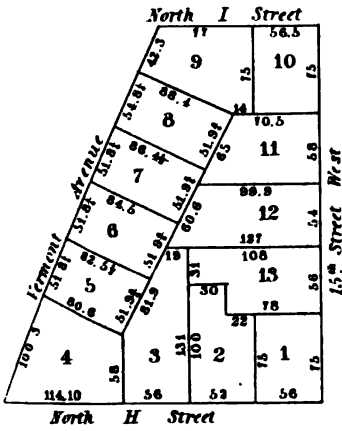

SQUARE N: 220

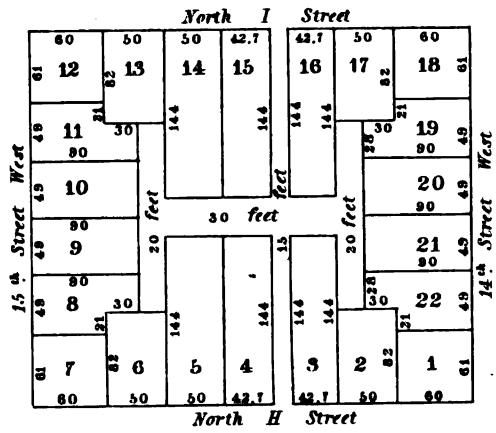

SQUARE N: 221

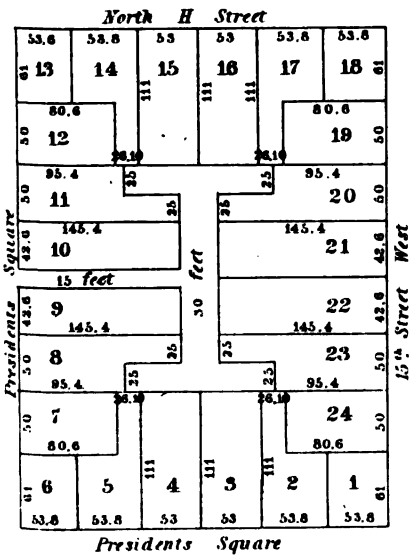

SQUARE N: 222

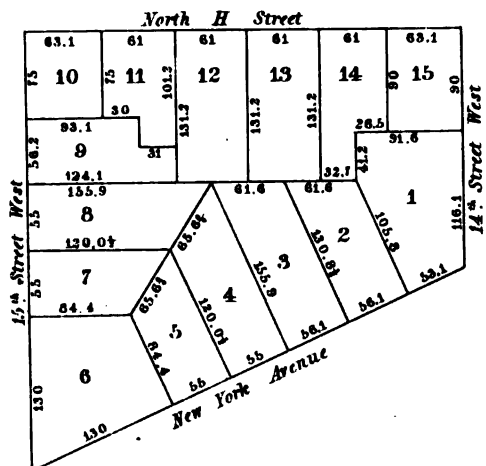









SQUARE N:232

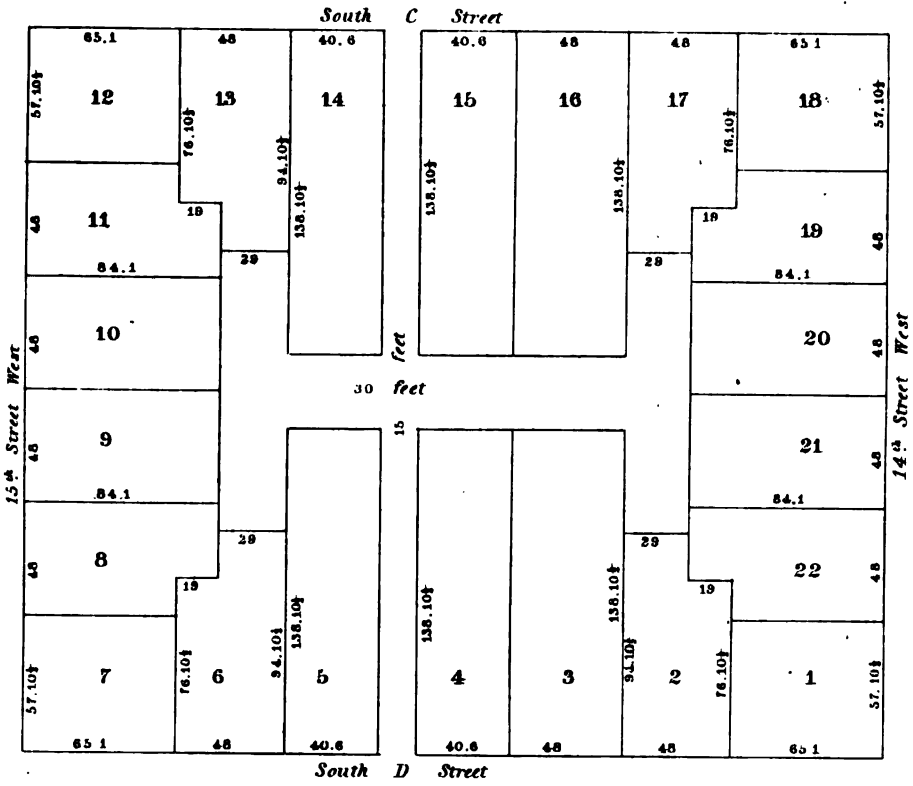

SQUARE N:234

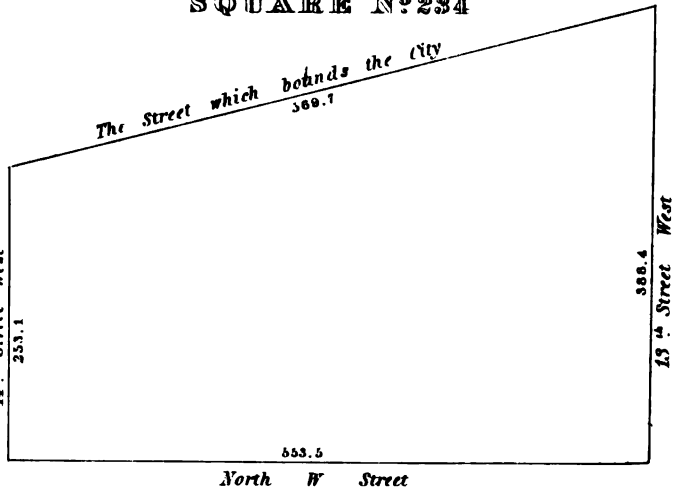

SQUARE N:233

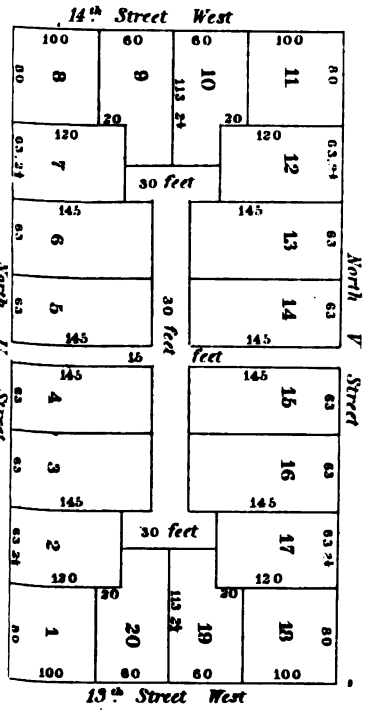
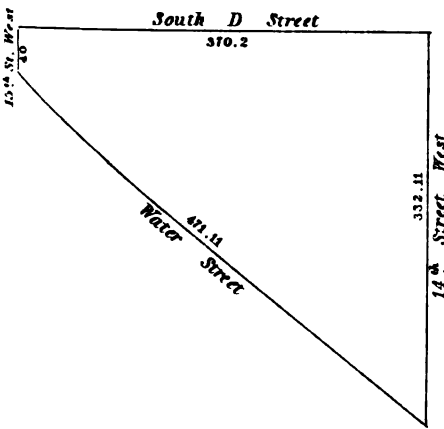

SQUARE N:236

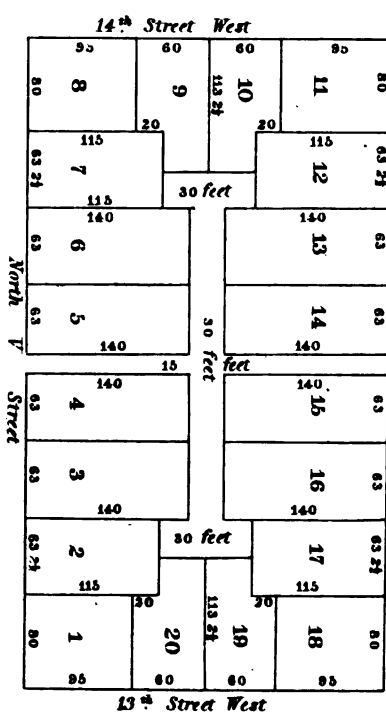

SQUARE N:235

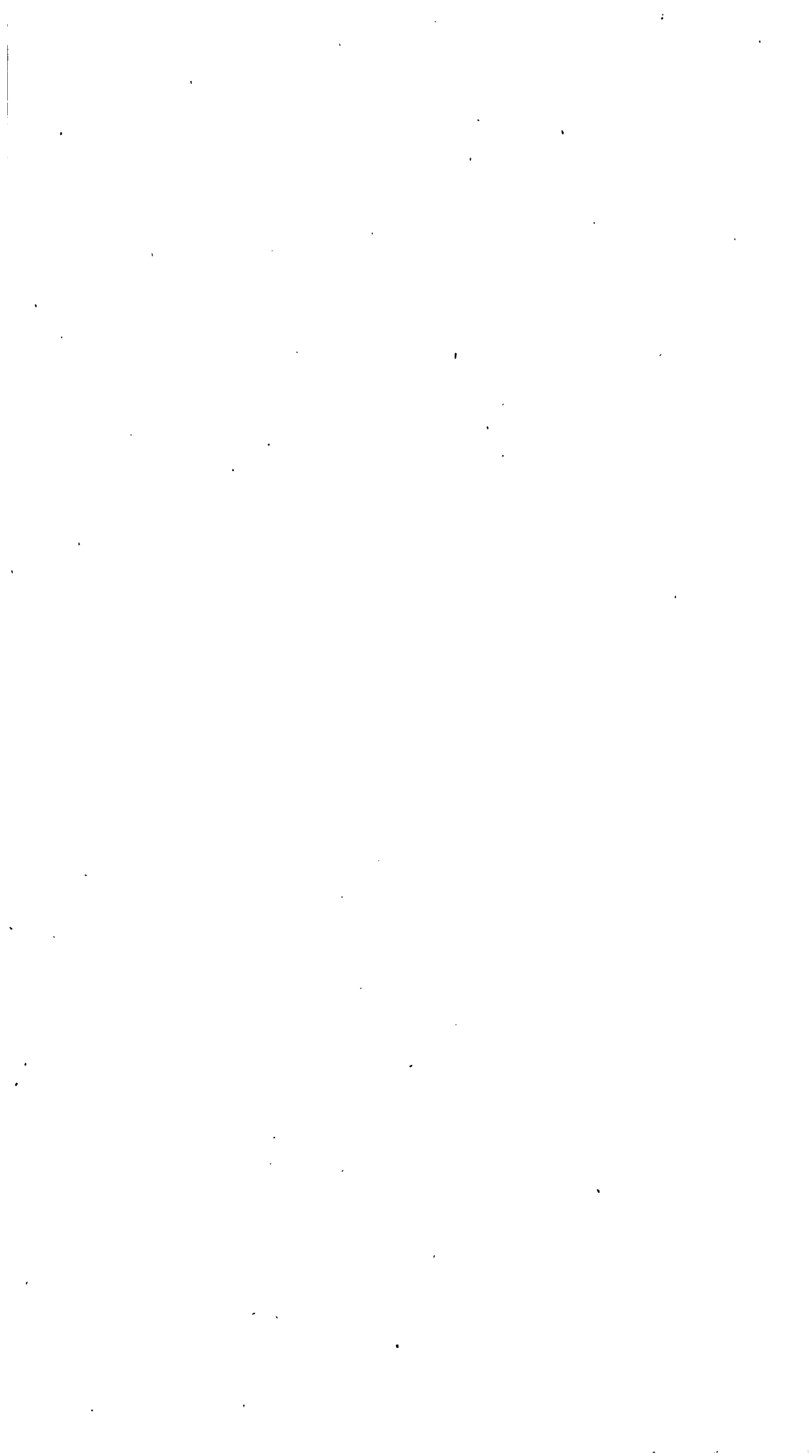

SQUARE N:237

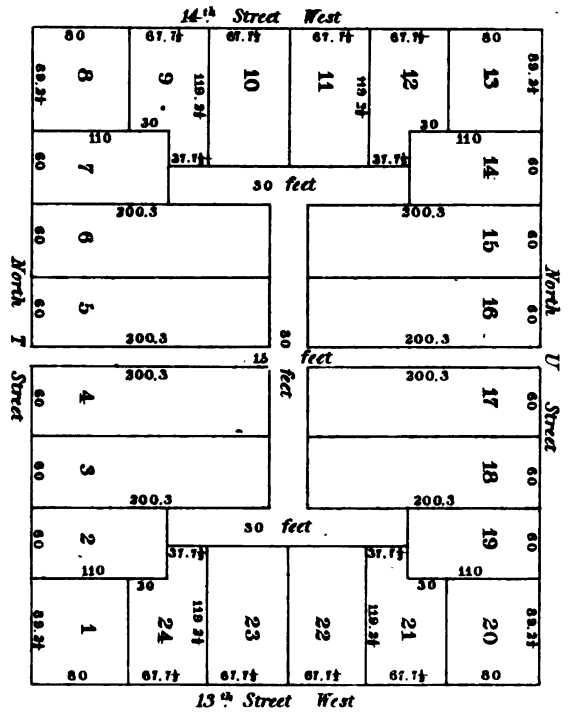

SQUARE N:239

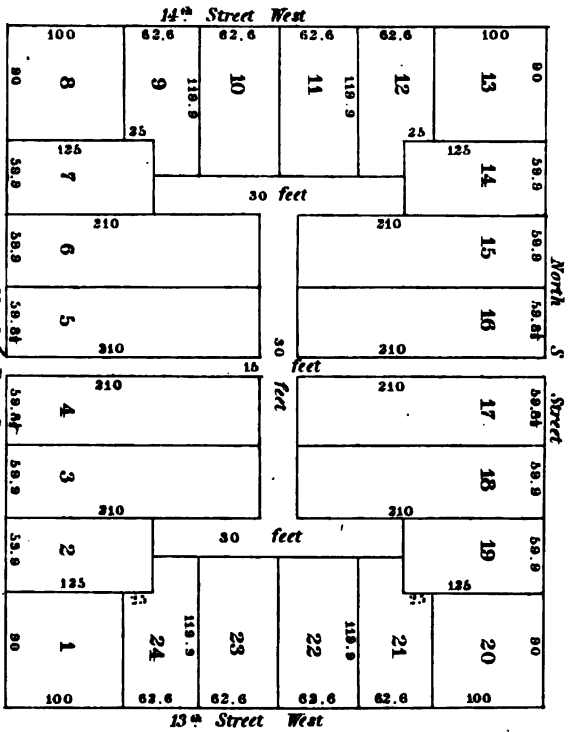

SQUARE N:241

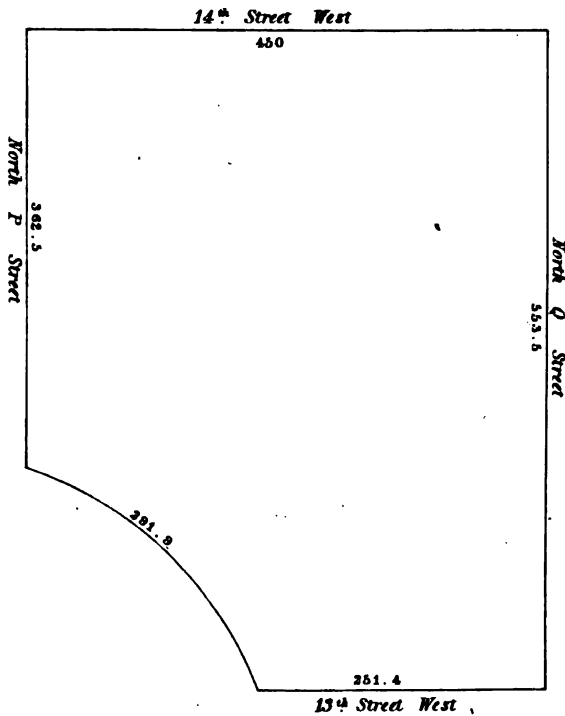

SQUARE N:238

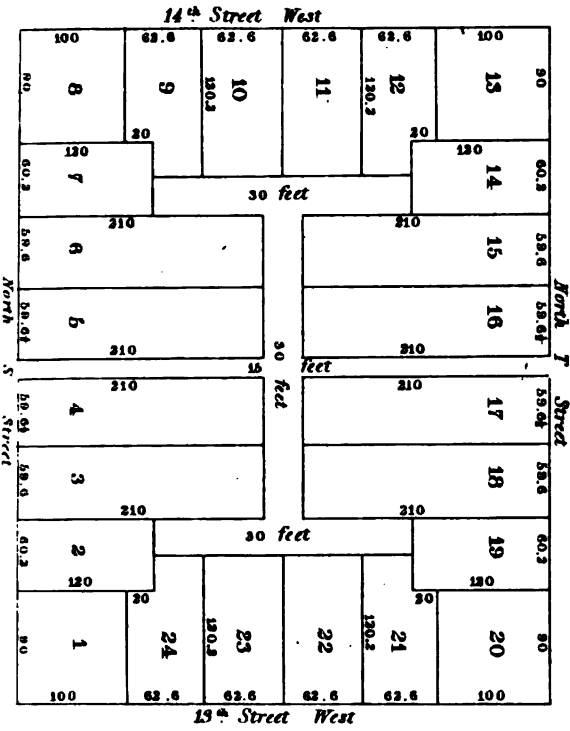

SQUARE N:240

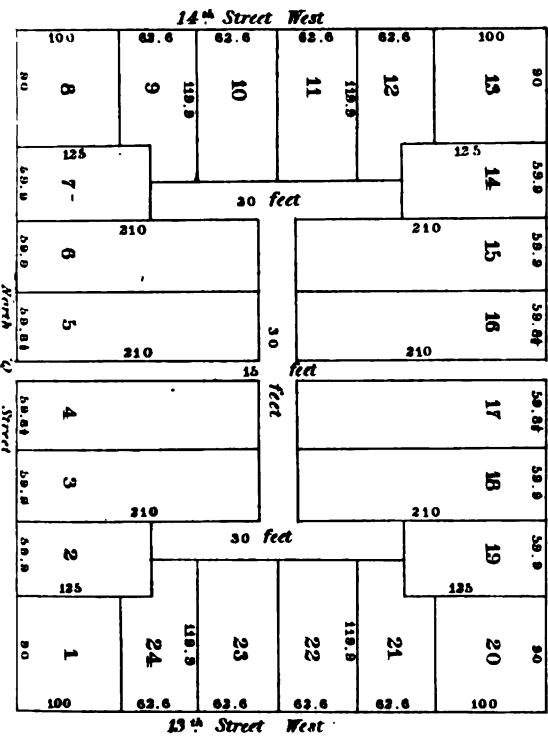

SQUARE N. OF N:242

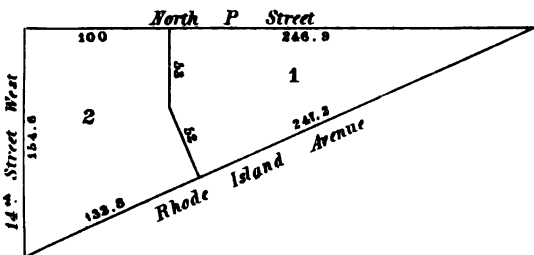



SQUARE N°242

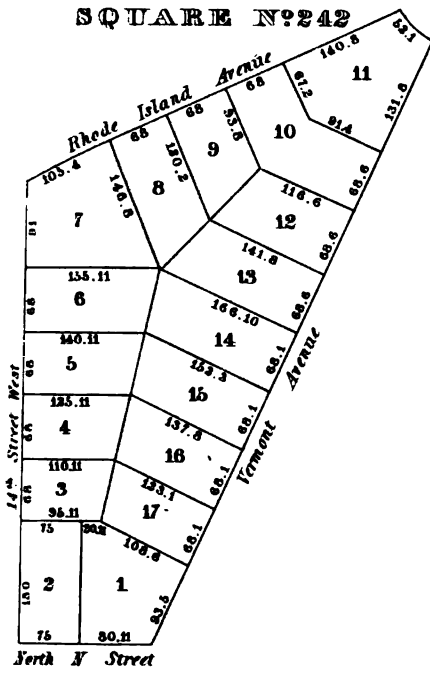

SQUARE N°243

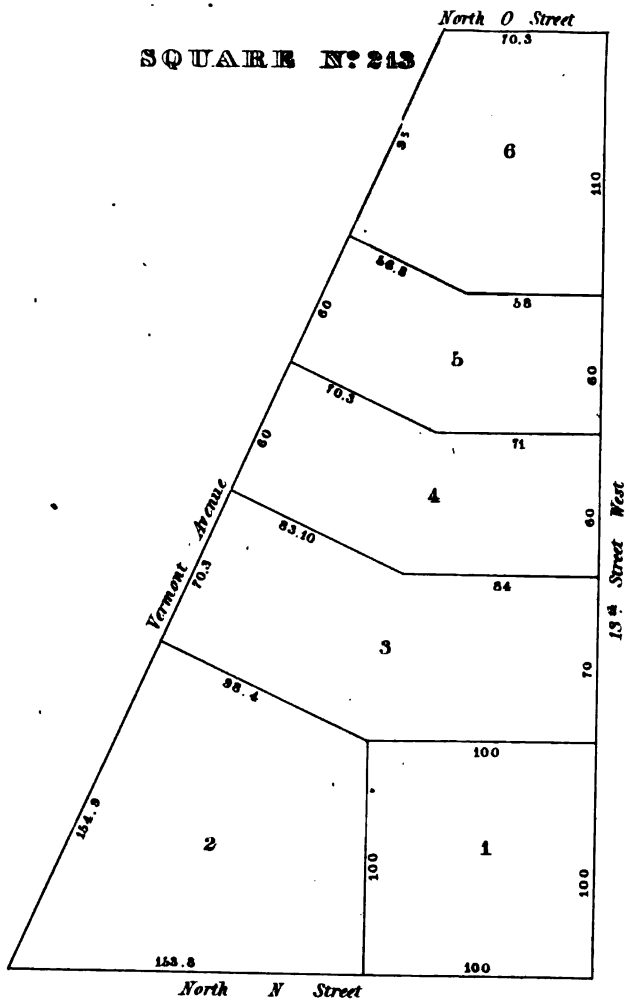

SQUARE N°244

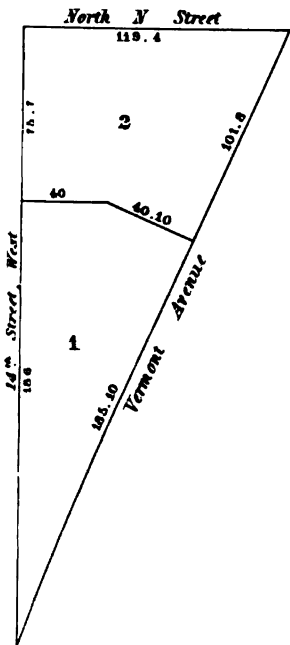

SQUARE N°245

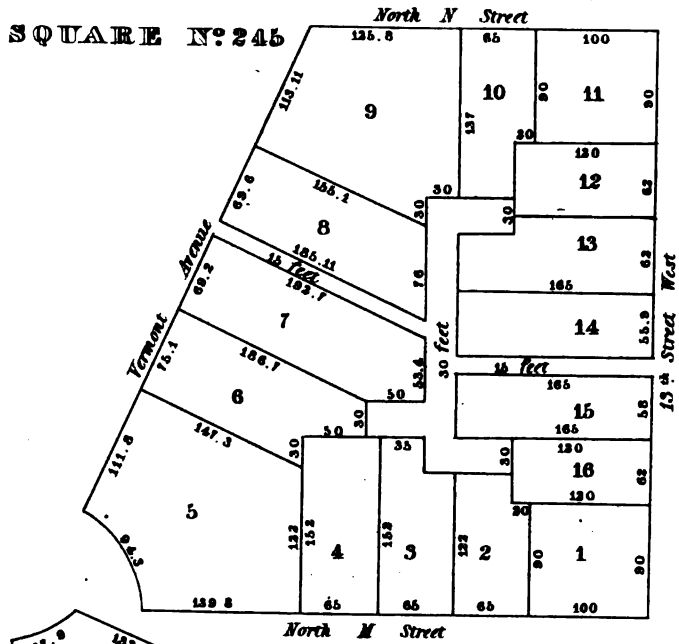

SQUARE N°246

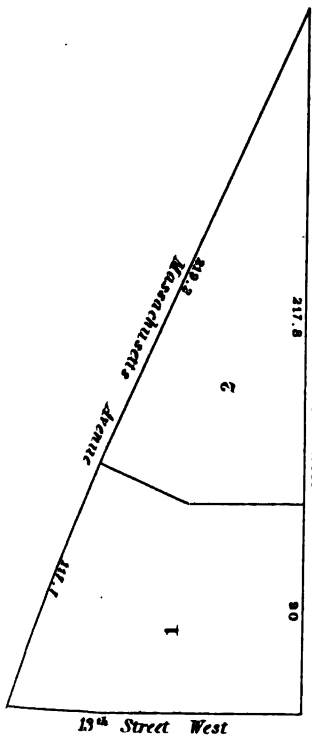

SQUARE N°247

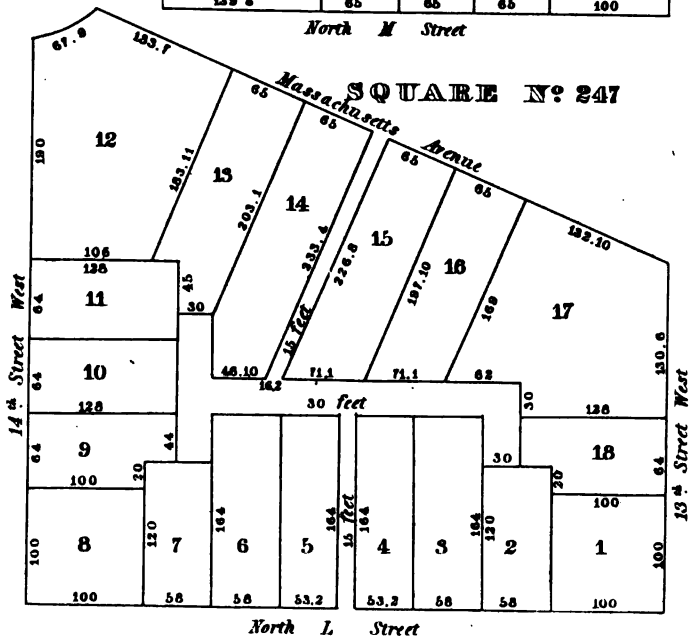





**SQUARE N° 248**

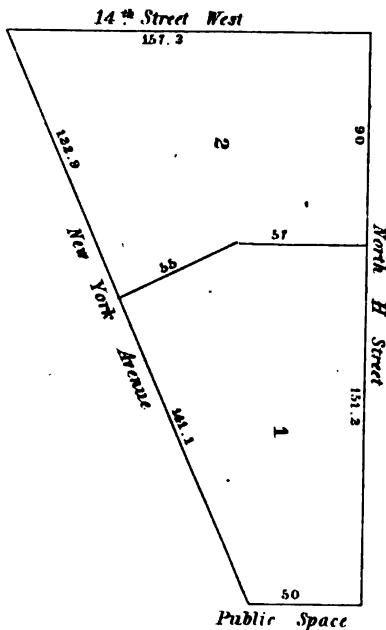
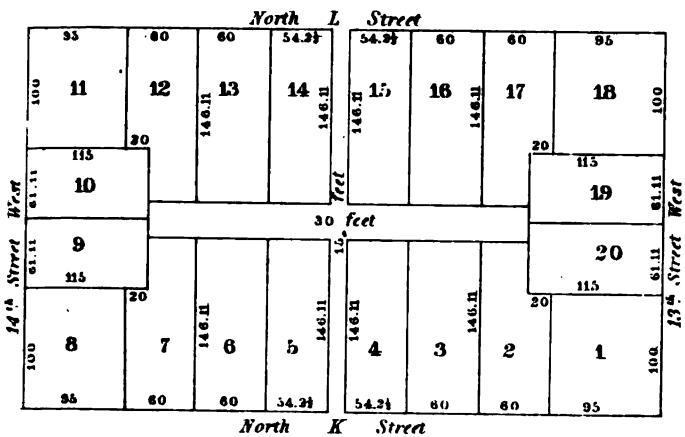

**SQUARE N° 251**

**SQUARE N° 249**

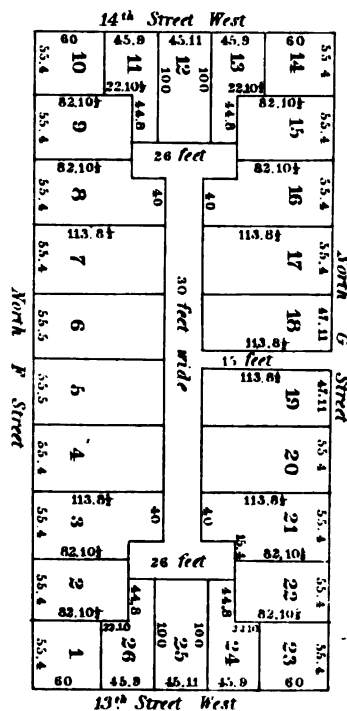
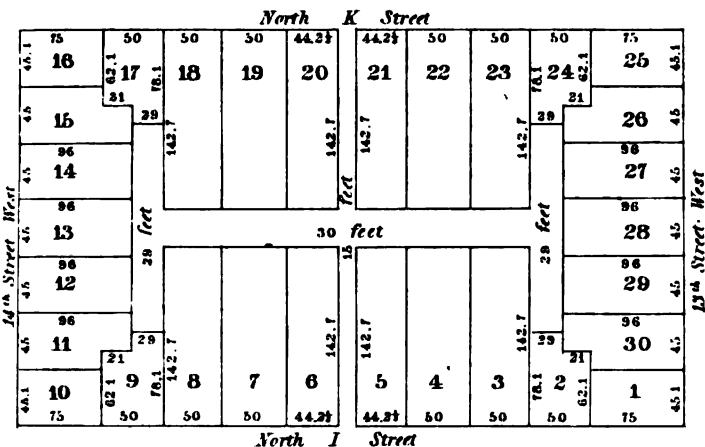

**SQUARE N° 253**

**SQUARE N° 250**

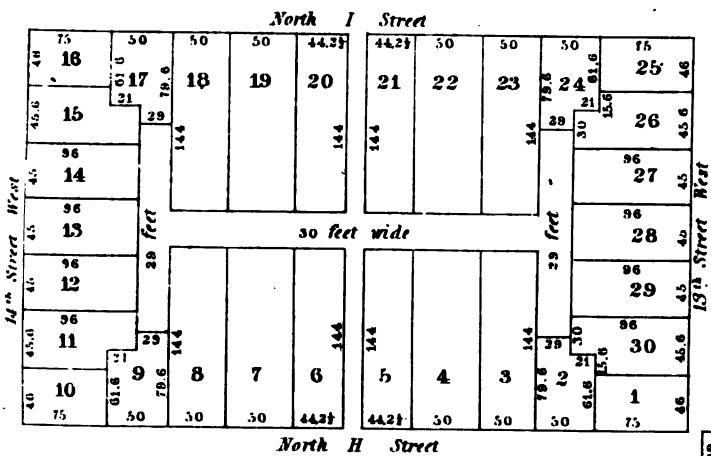

**SQUARE N° 252**

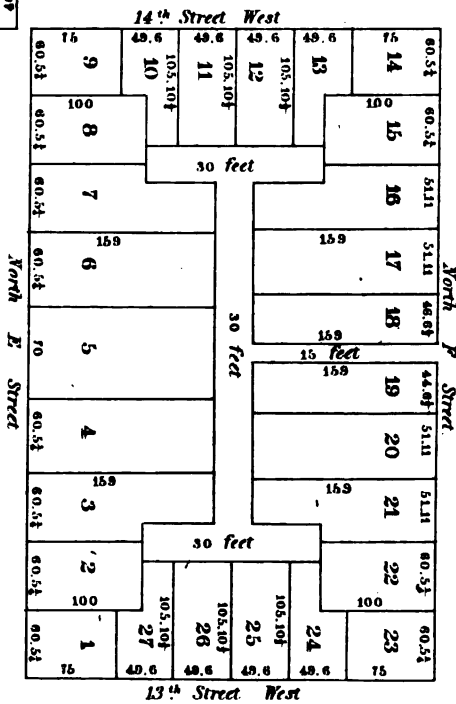
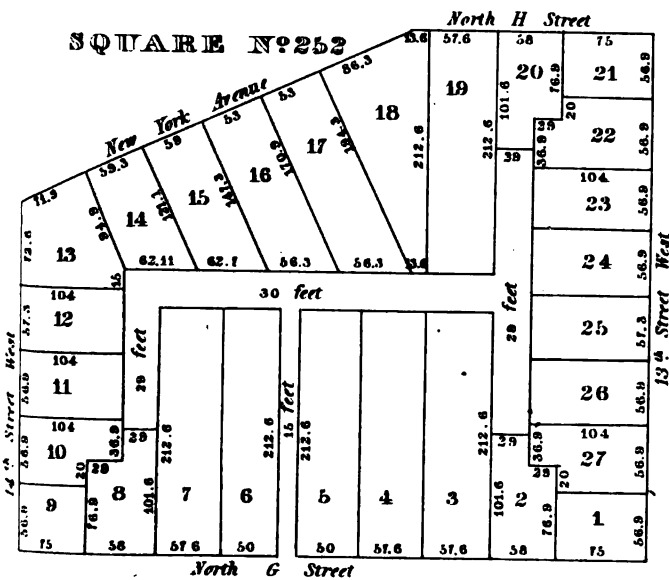

**SQUARE N° 254**



SQUARE N° 255

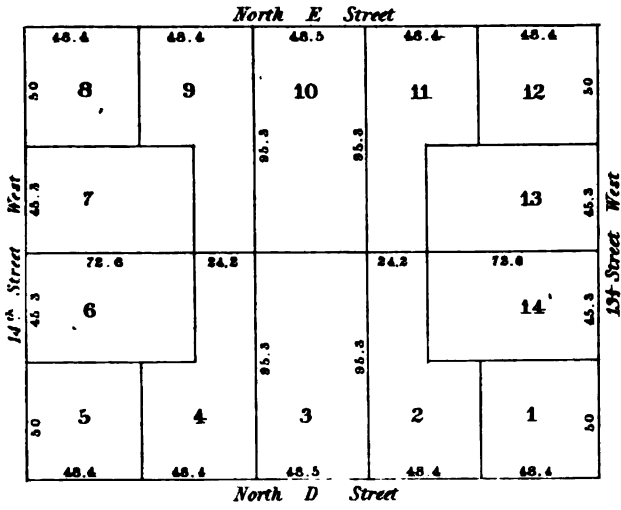

SQUARE N° 258

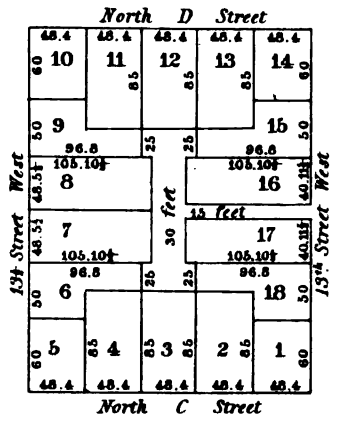

SQUARE N° 259

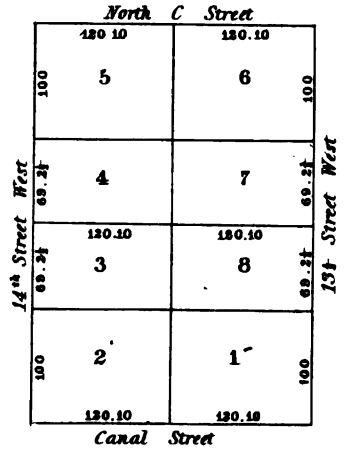

SQUARE N° 256

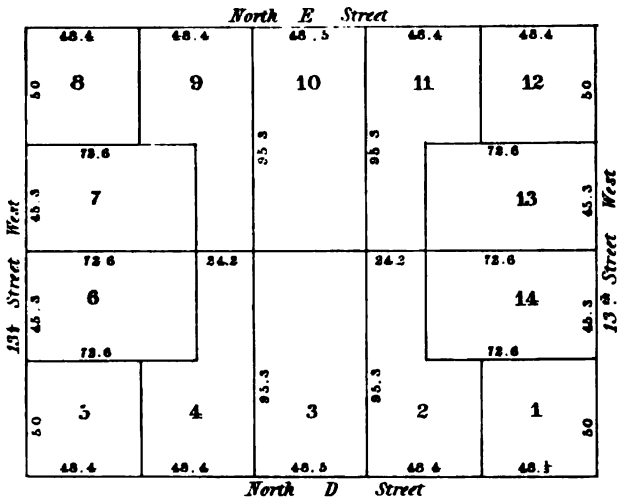

SQUARE N° 257

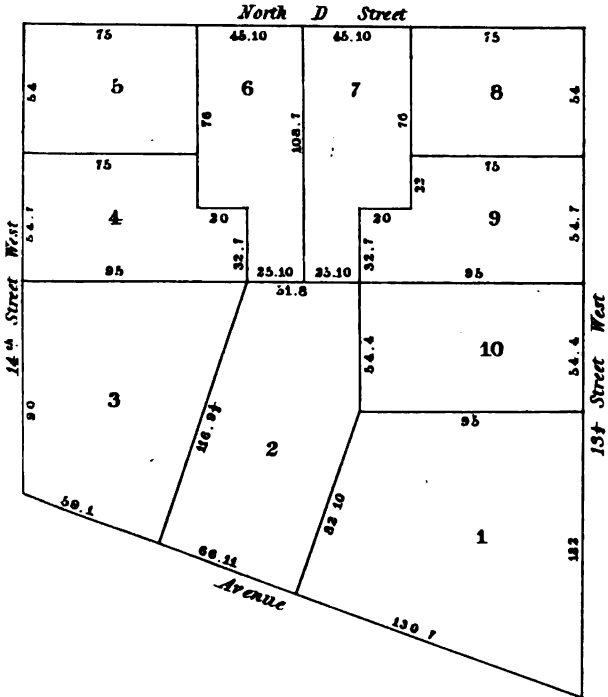

SQUARE N° 260

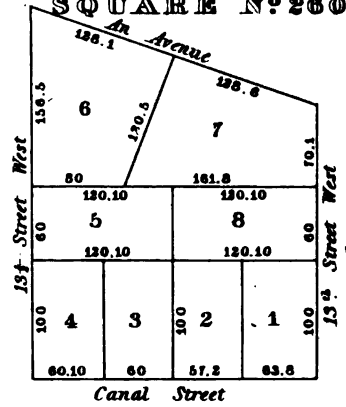

SQUARE N° 264

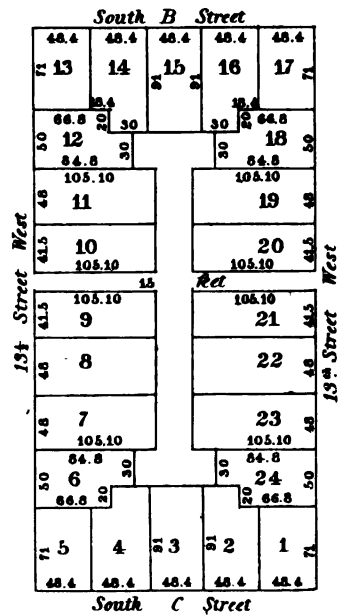

SQUARE N° 263

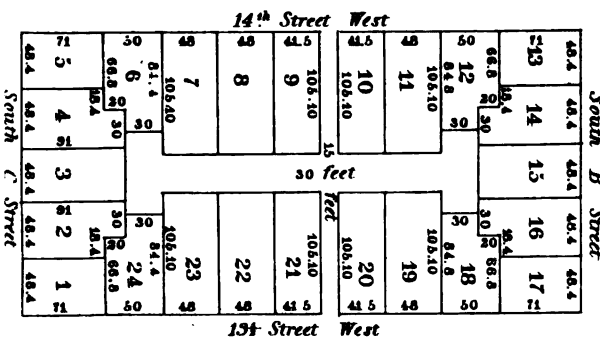







**SQUARE N:271**

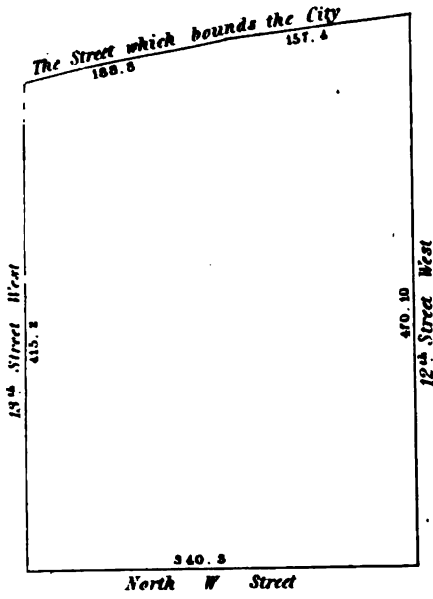

**SQUARE N:272**

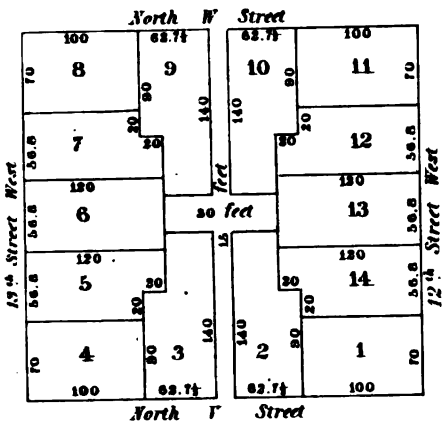

**SQUARE N:273**

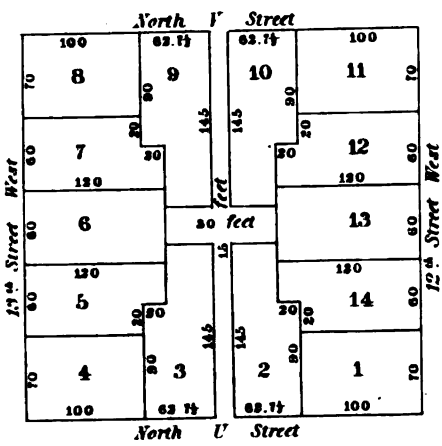

**SQUARE N:274**

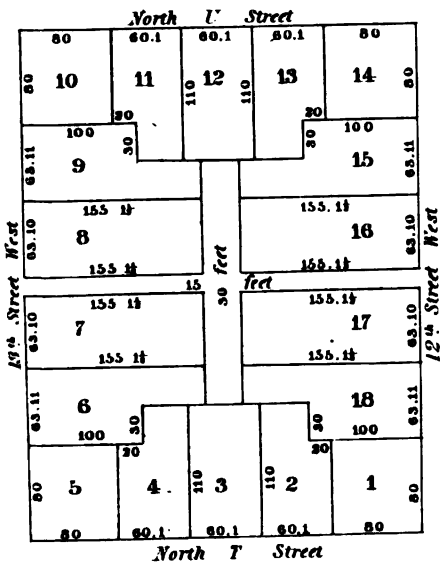

**SQUARE N:275**

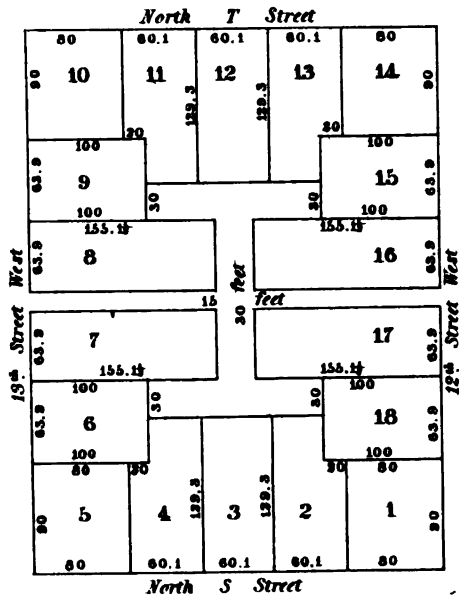

**SQUARE N:276**

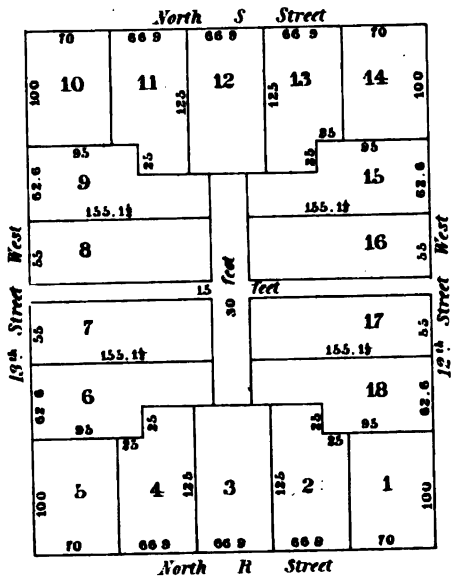

**SQUARE N:277**

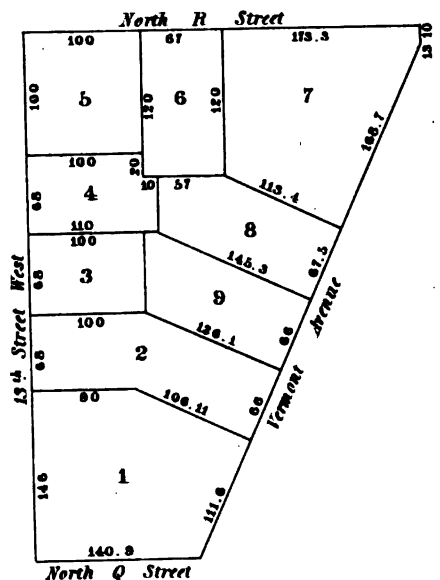

**SQUARE S. OF N:274**

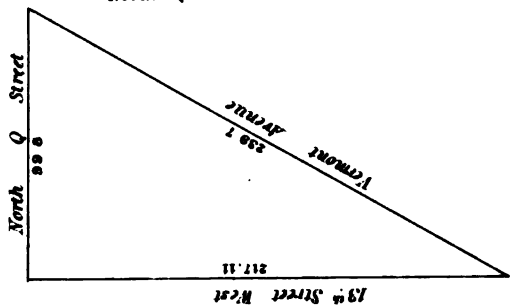





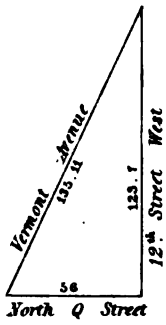
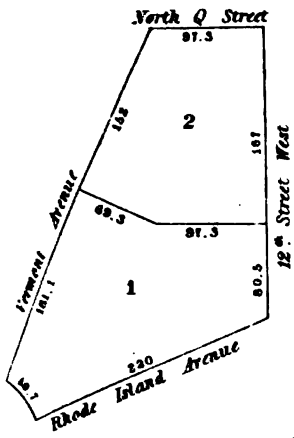

SQUARE N°279

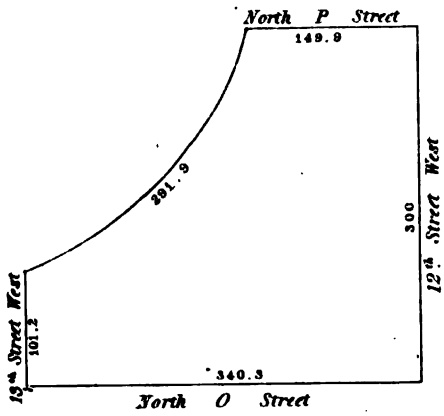

SQUARE N°280

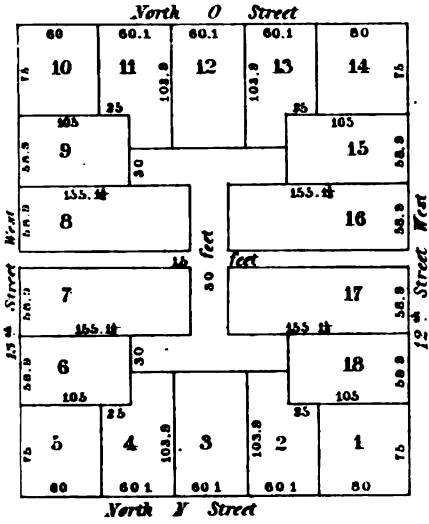

SQUARE N°281

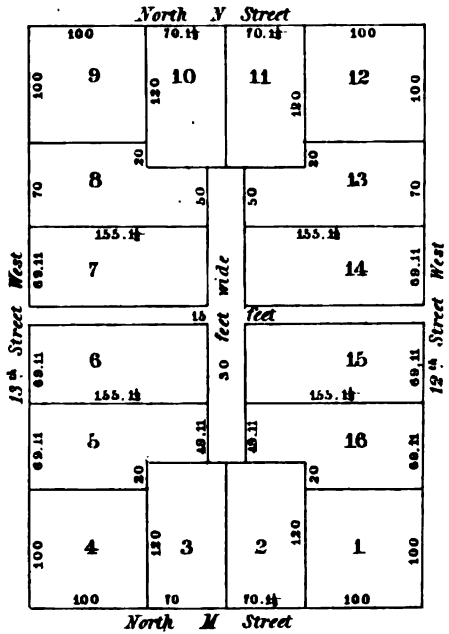

SQUARE N°282

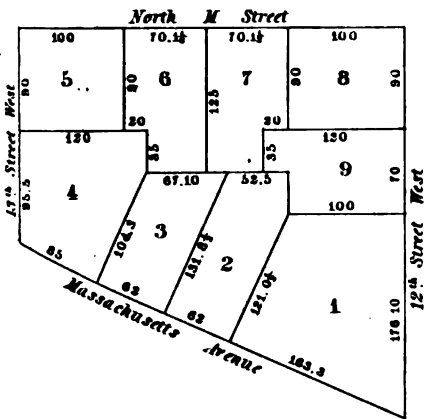

SQUARE N°284

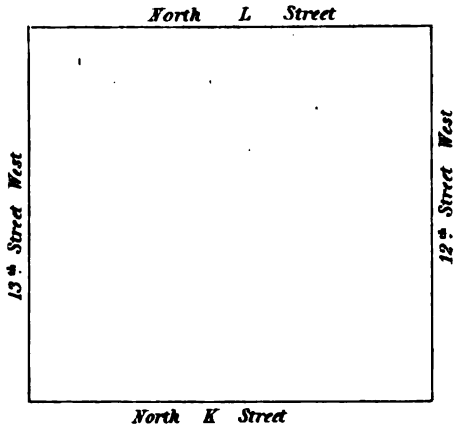

SQUARE N°283

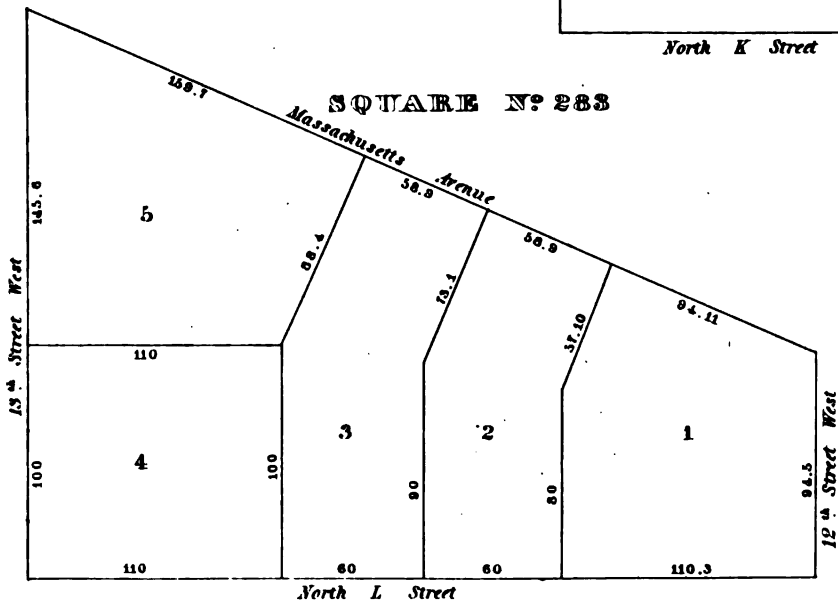

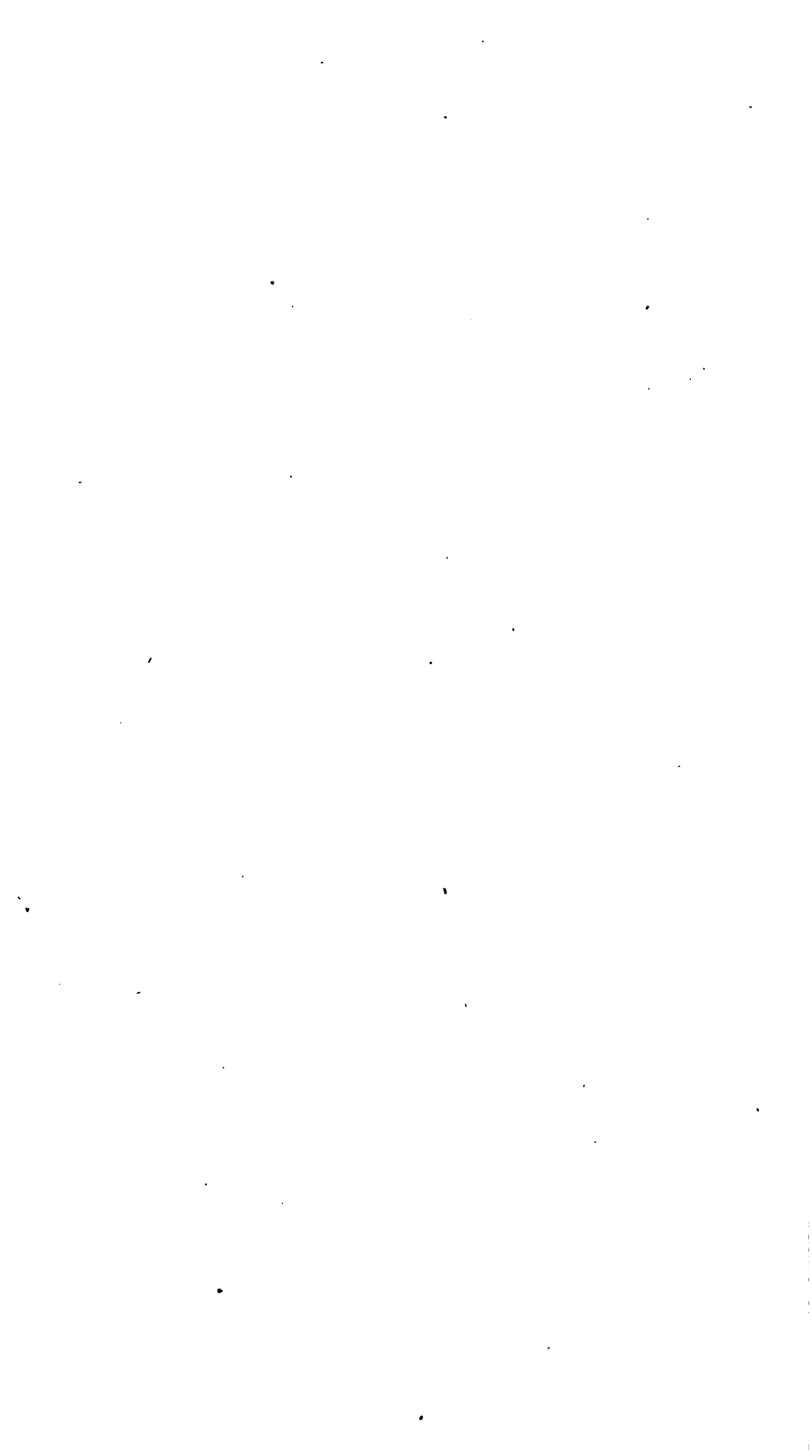

SQUARE N°285

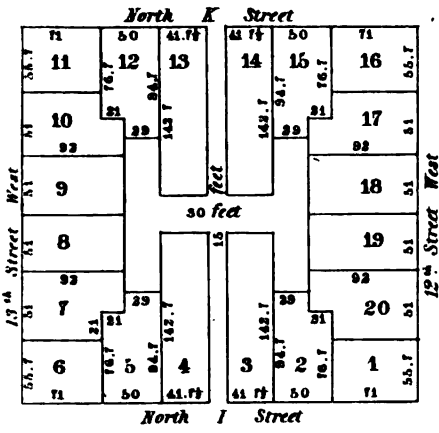

SQUARE N°281

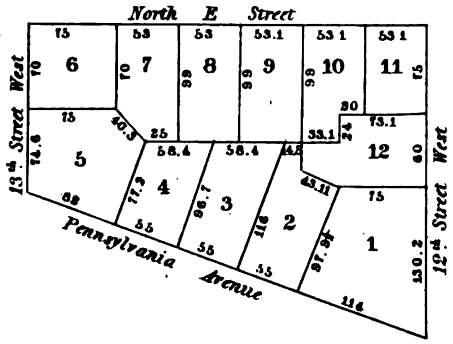

SQUARE N°283

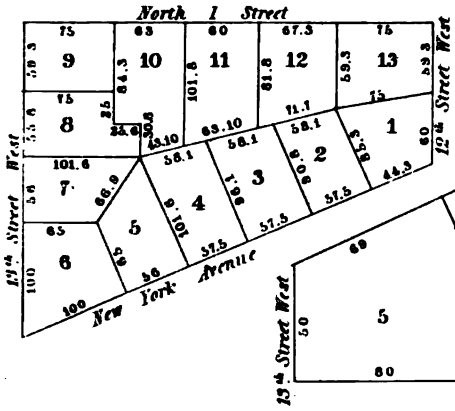

SQUARE N°287

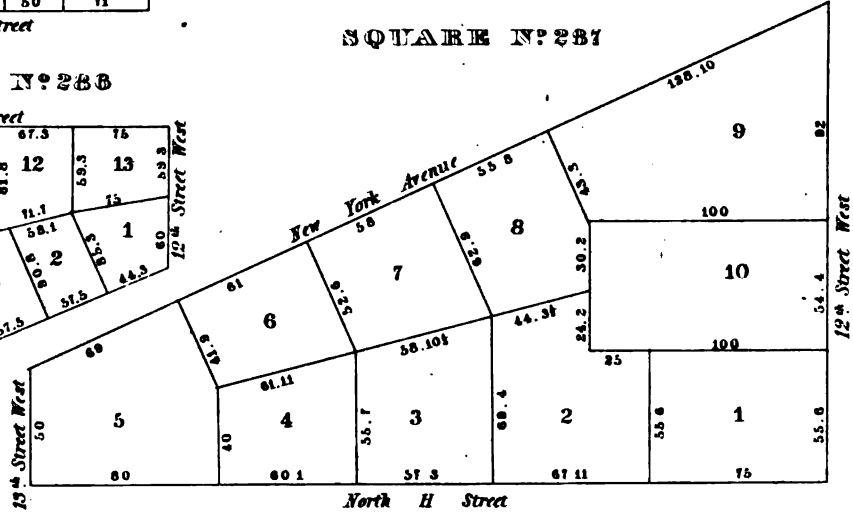

SQUARE N°288

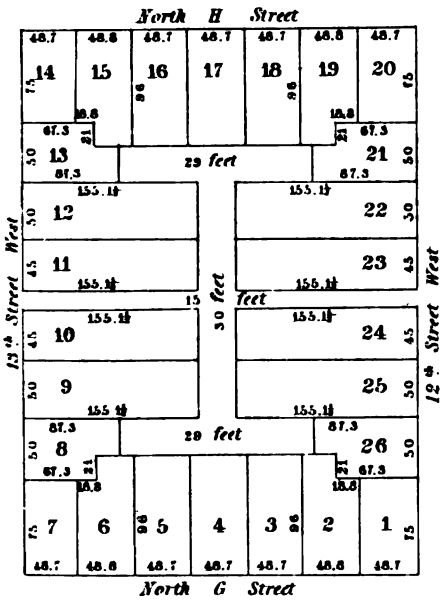

SQUARE N°289

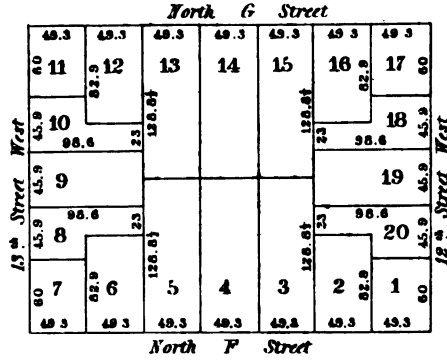

SQUARE N°290

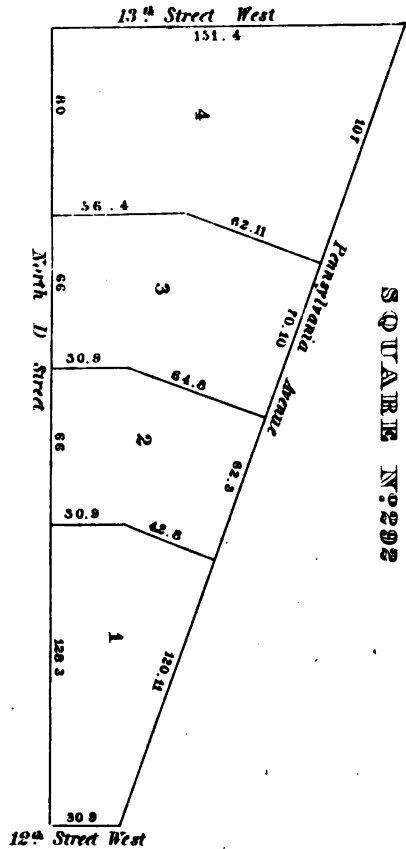
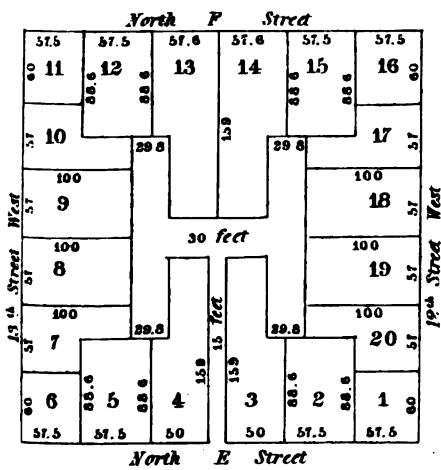



SQUARE N:293

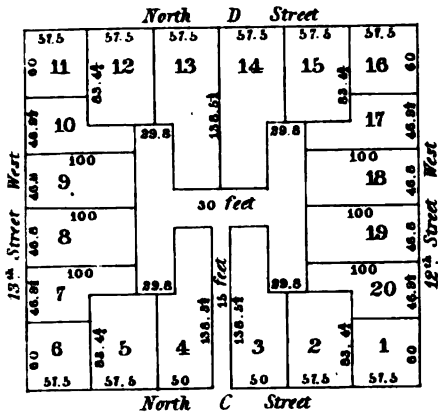

SQUARE N:297

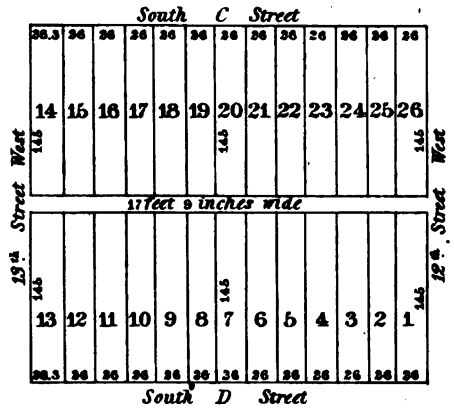

SQUARE N:294

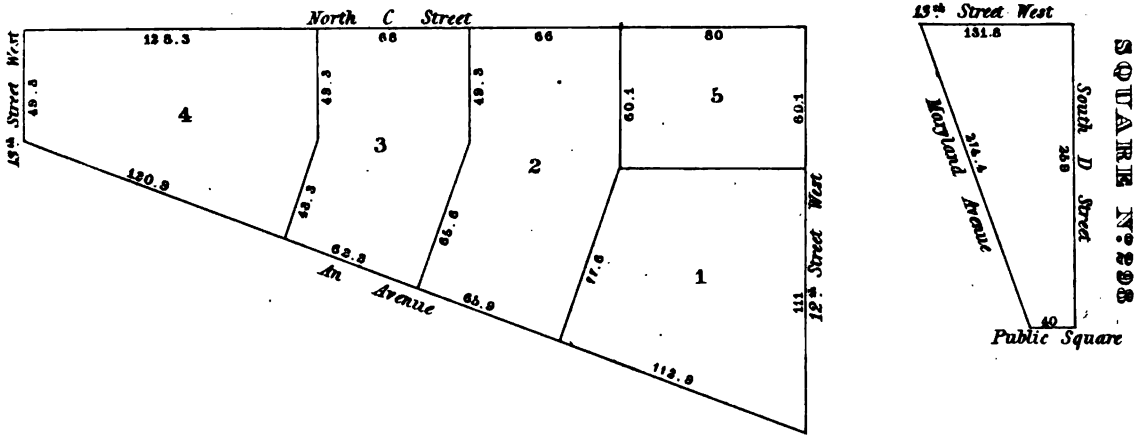

SQUARE N:300

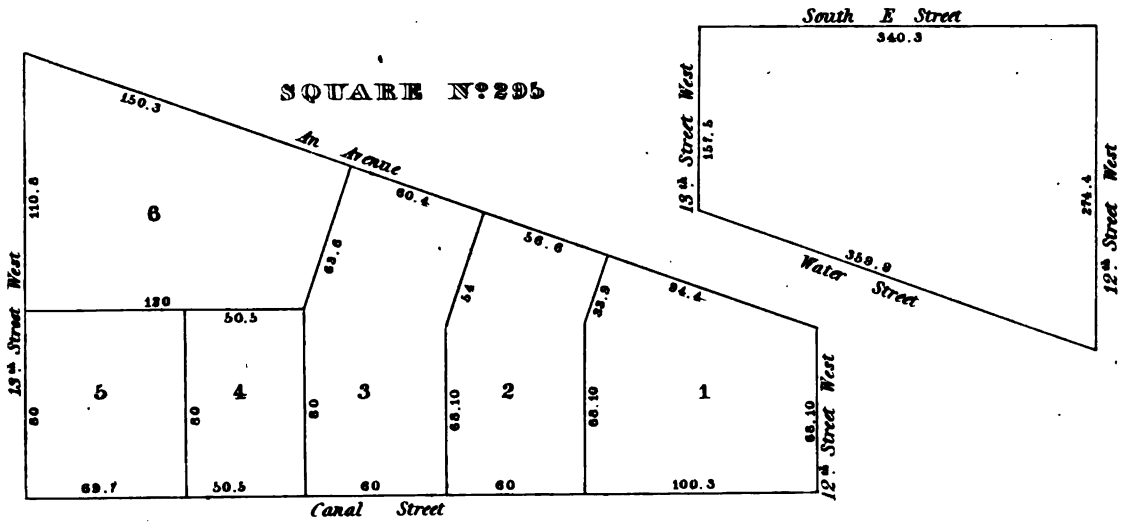

SQUARE N:296

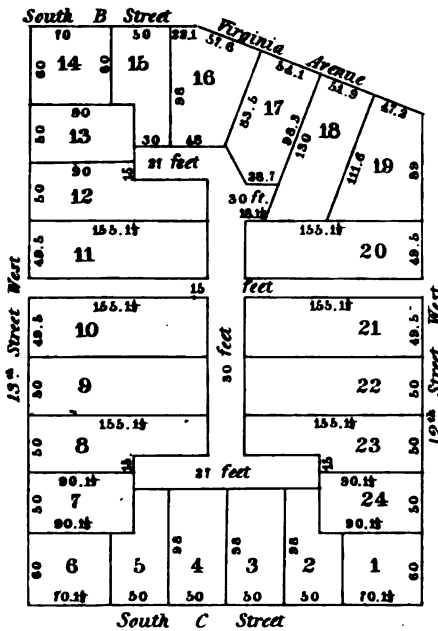

SQUARE N:299

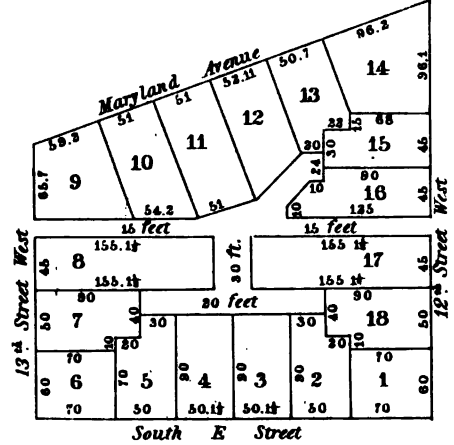



**SQUARE N° 305**

North U Street

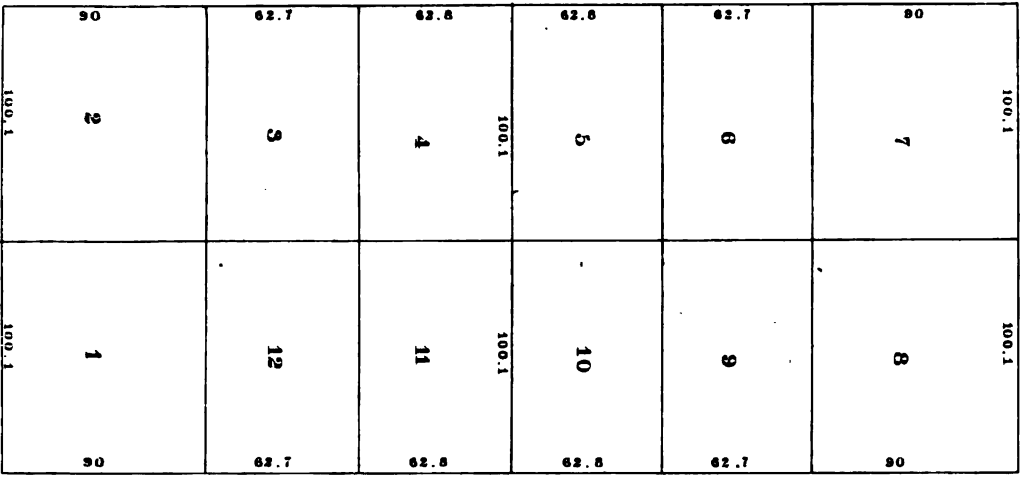

12<sup>th</sup> Street West

11<sup>th</sup> Street West

**SQUARE N° 302**

The Street which bounds the City

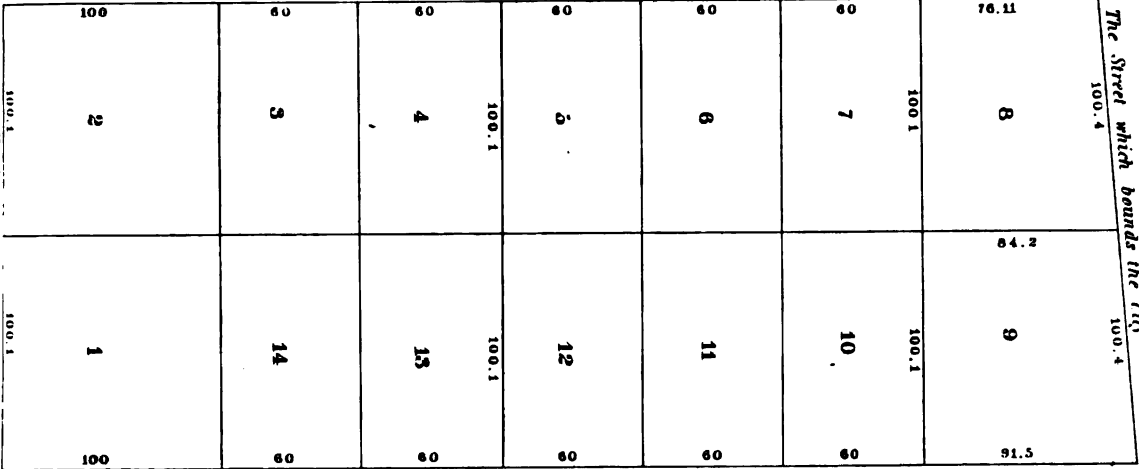

12<sup>th</sup> Street West

11<sup>th</sup> Street West

**SQUARE N° 303**

North W Street

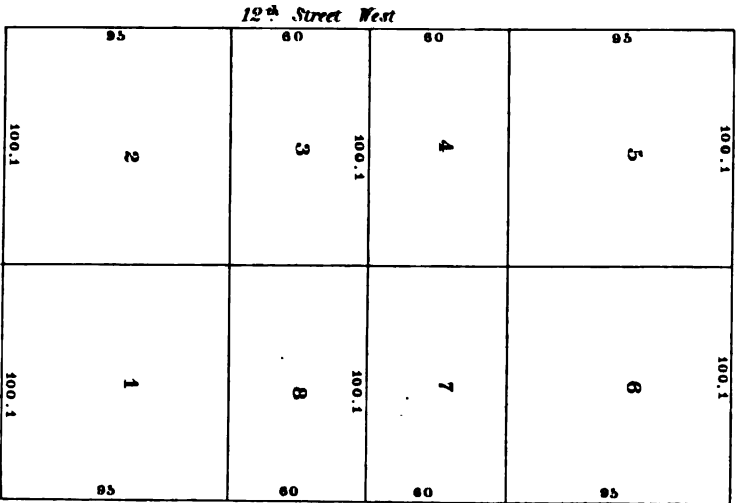

12<sup>th</sup> Street West

11<sup>th</sup> Street West

**SQUARE N° 304**

North V Street

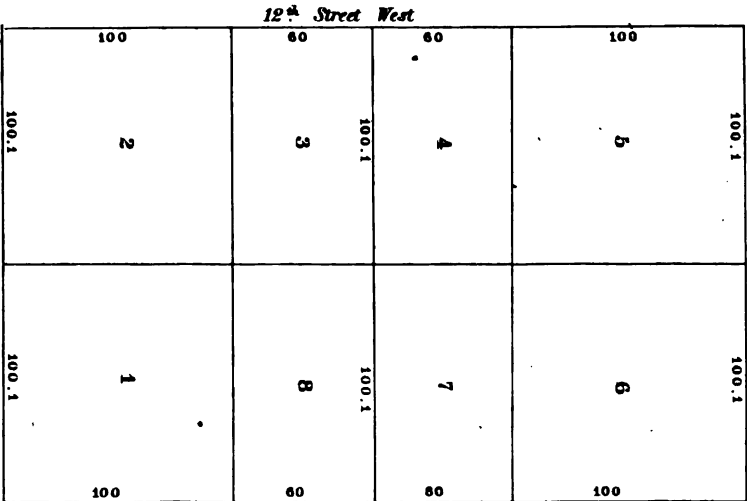

12<sup>th</sup> Street West

11<sup>th</sup> Street West

**SQUARE N° 306**

North T Street

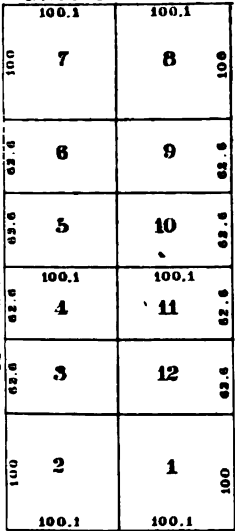

North Street will

**SQUARE N° 307**

North S Street

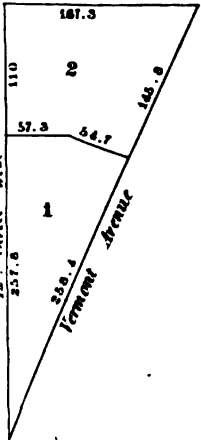





**SQUARE N° 308**

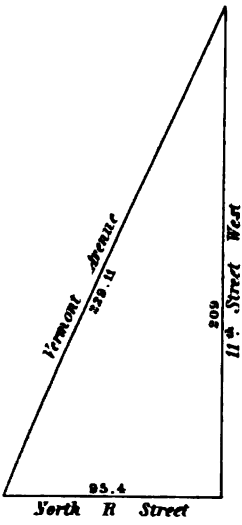

**SQUARE N° 309**

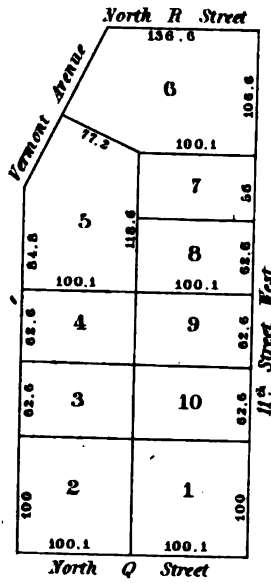

**SQUARE N° 310**

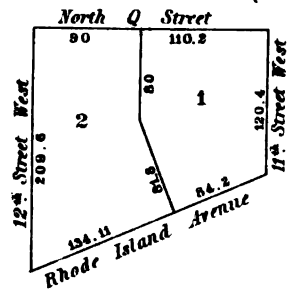

**SQUARE N° 312**

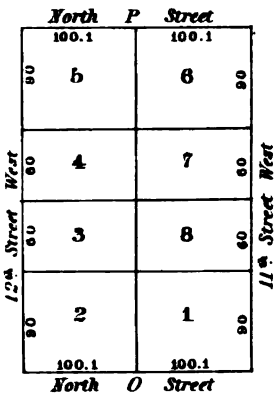

**SQUARE N° 311**

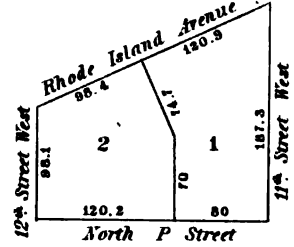

**SQUARE N° 313**

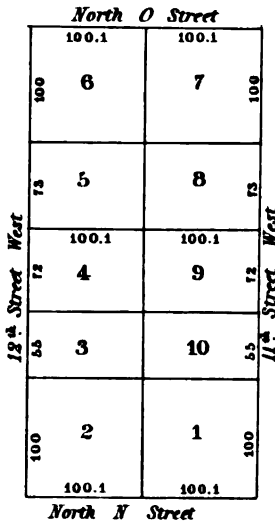

**SQUARE N° 314**

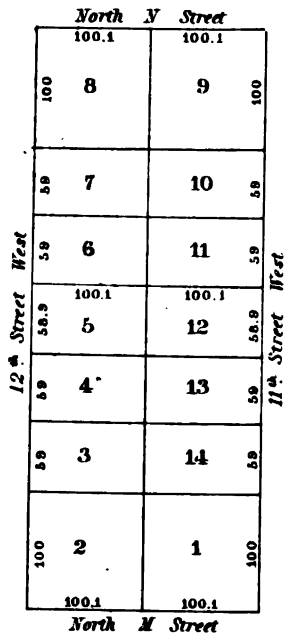

**SQUARE N° 315**

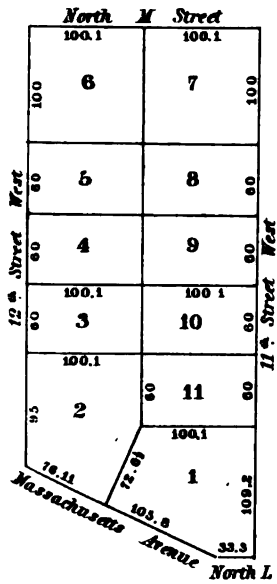

**SQUARE N° 316**

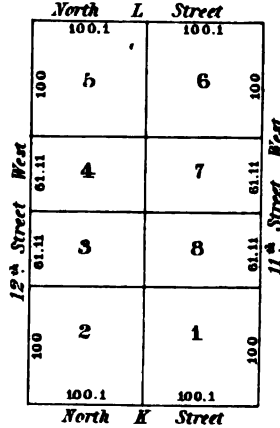

**SQUARE N° 317**

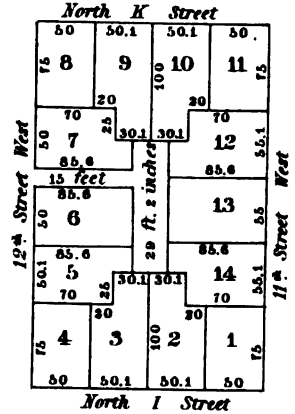

**SQUARE N° 318**

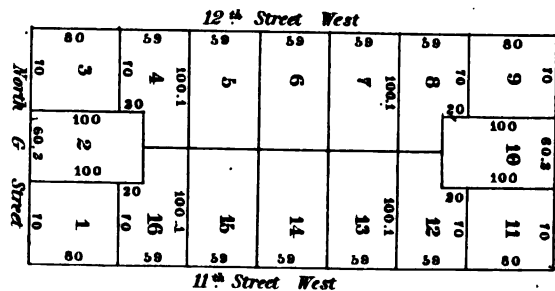
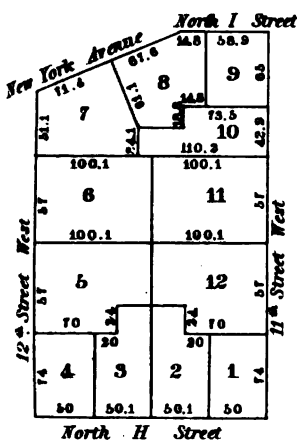

**SQUARE N° 319**



SQUARE N°320

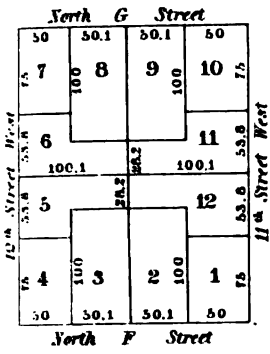

SQUARE N°321

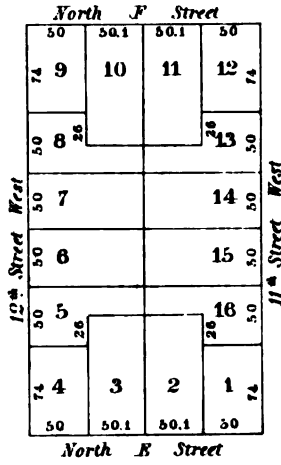

SQUARE N°322

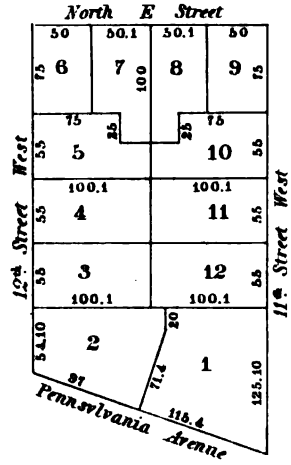

SQUARE N°323

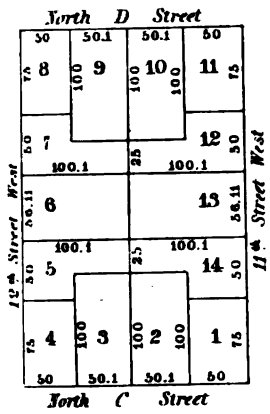

SQUARE N°324

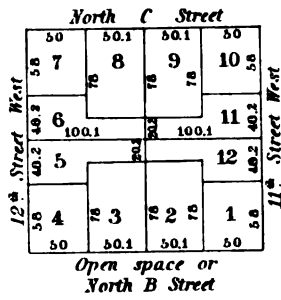

SQUARE N°325

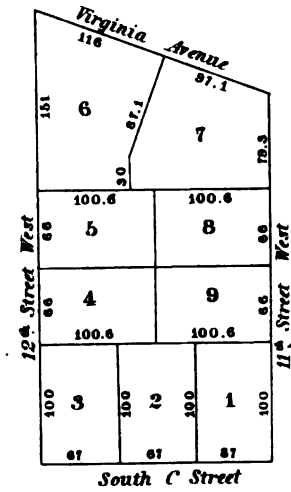

SQUARE N°327

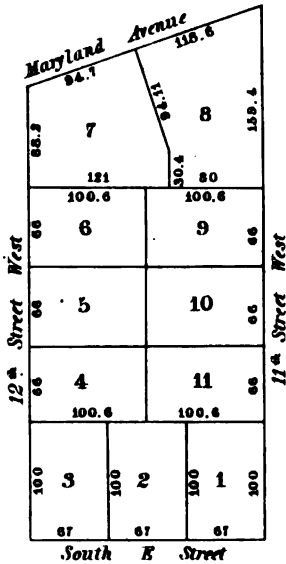

SQUARE N°328

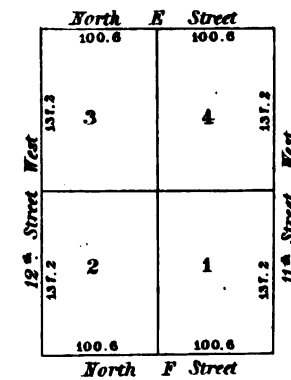

SQUARE N°326

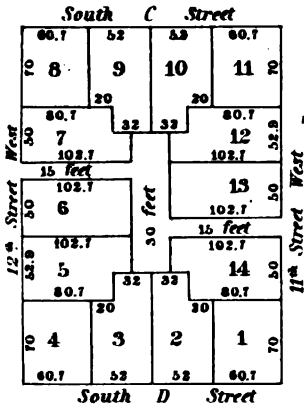

SQUARE N°330

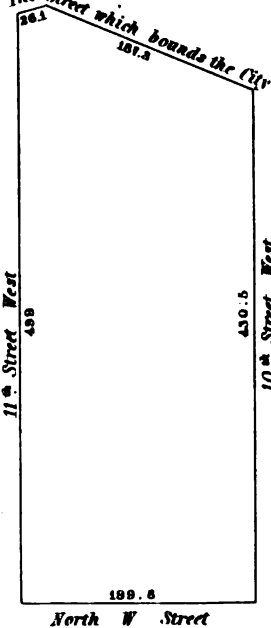

SQUARE N°332

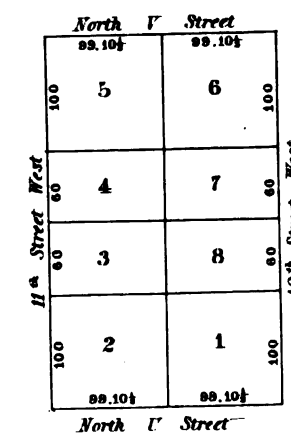

SQUARE N°329

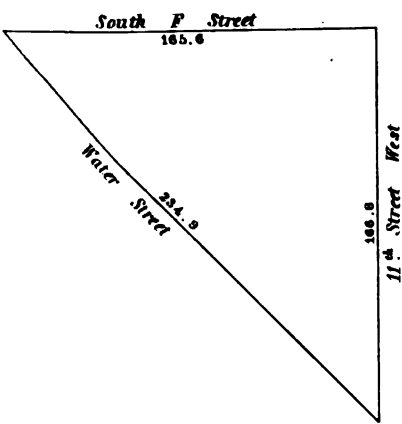



**SQUARE N:331**

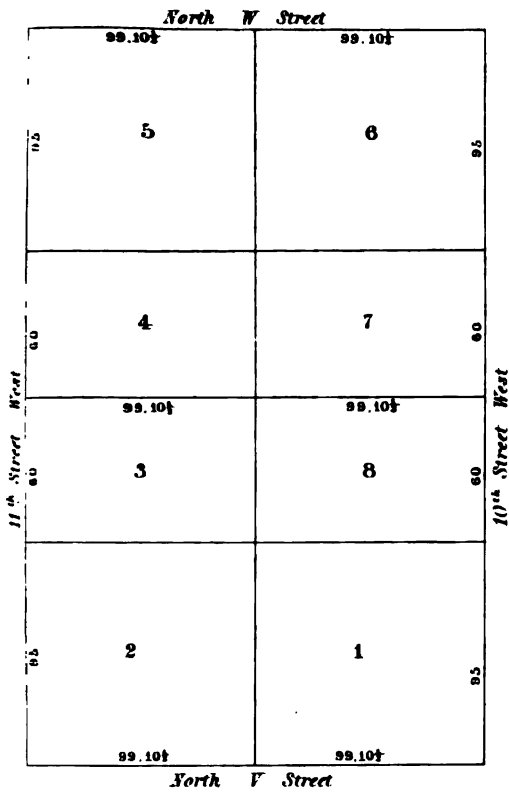

**SQUARE N:333**

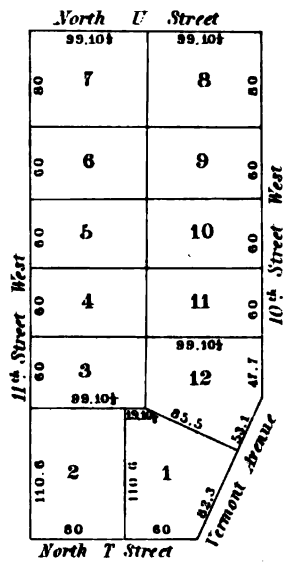

**SQUARE N. OF N:334**



**SQUARE N. OF N:331**

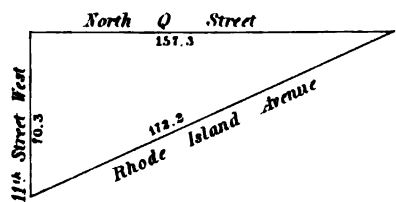

**SQUARE N:334**

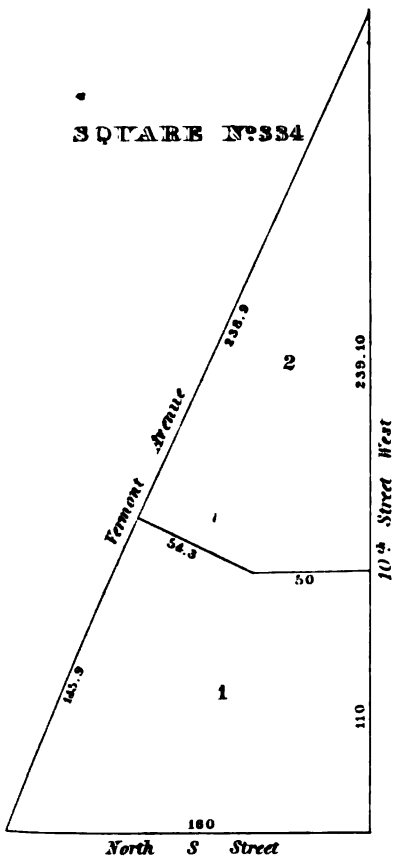

**SQUARE N:335**

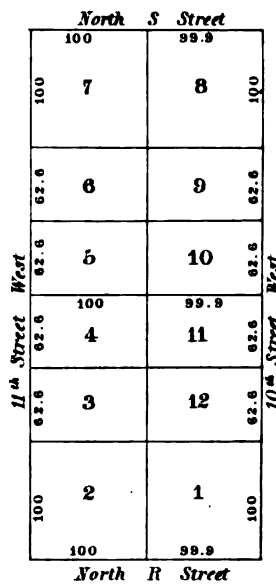

**SQUARE N:336**

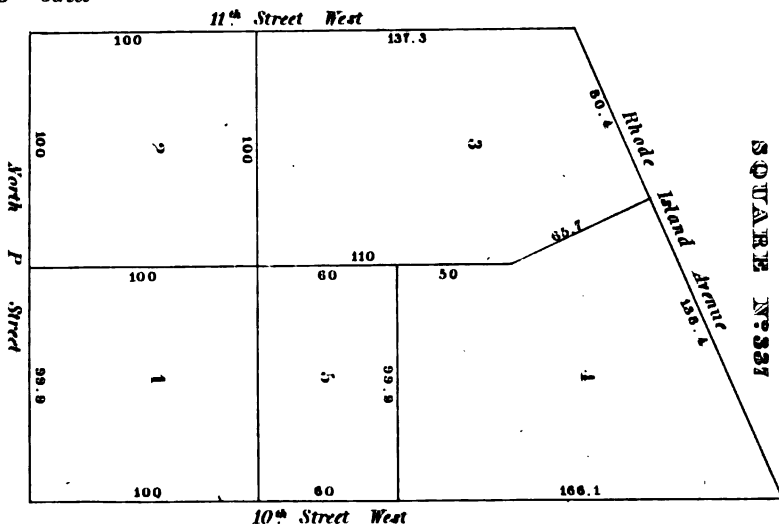
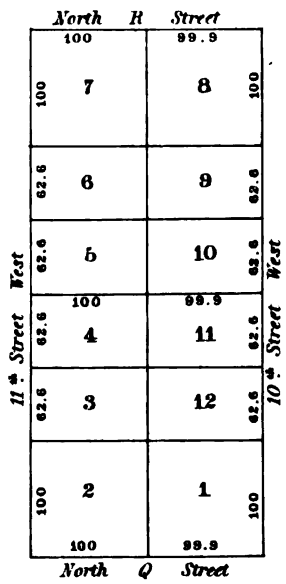

**SQUARE N:337**



**SQUARE N° 338**

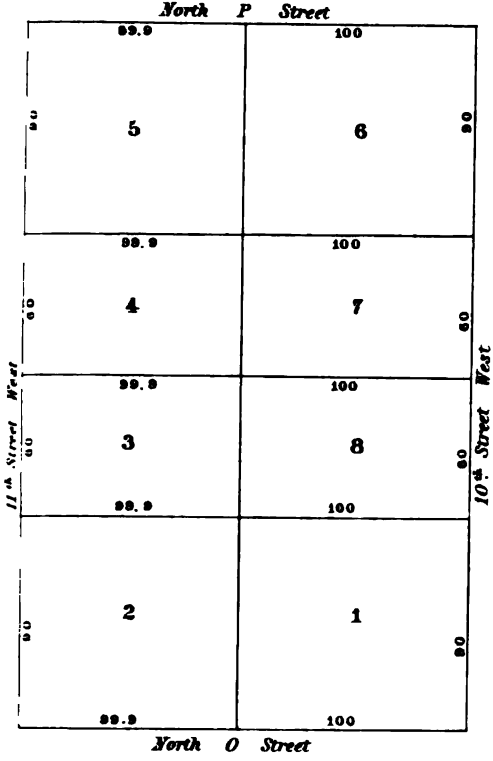

**SQUARE N° 339**

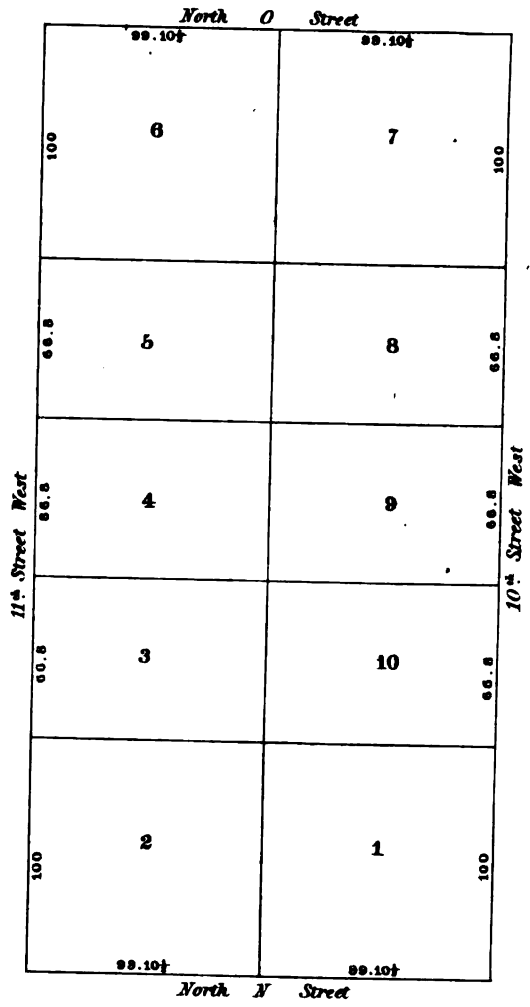

**SQUARE N° 341**

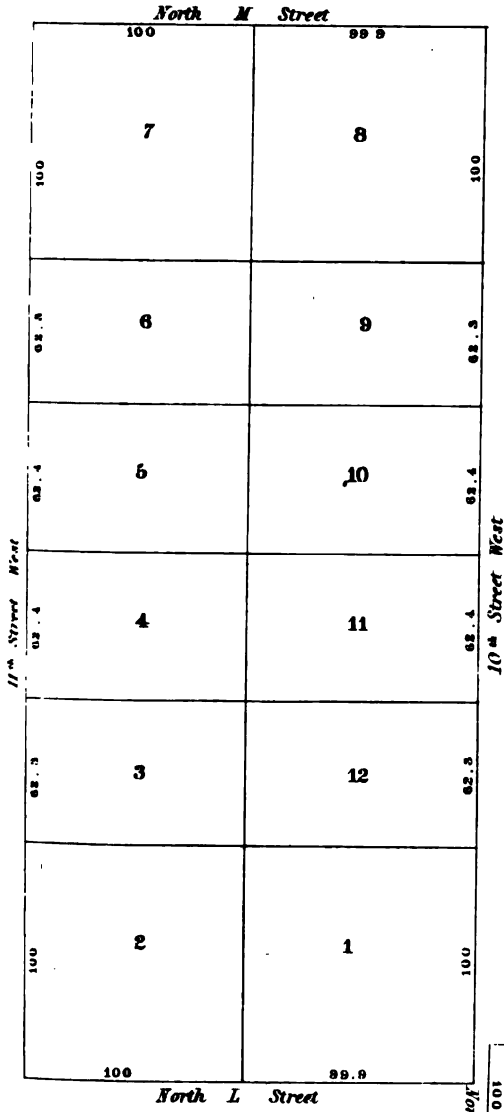

**SQUARE N° 342**

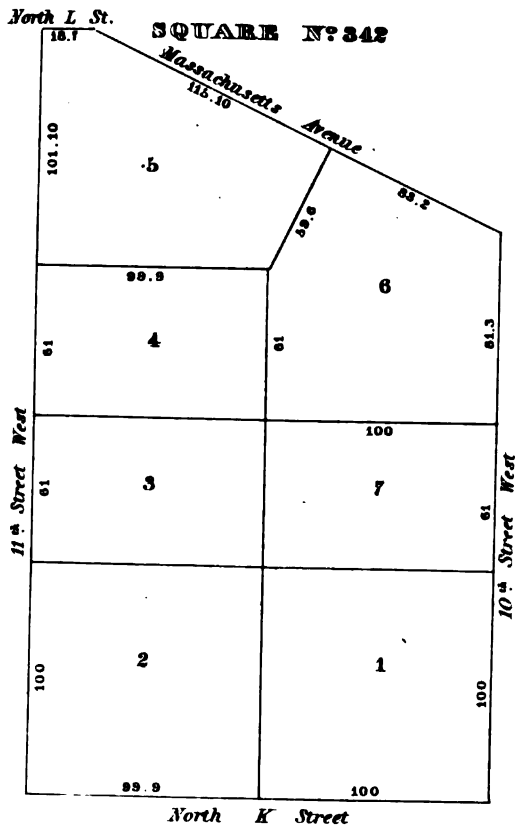

**SQUARE N° 340**

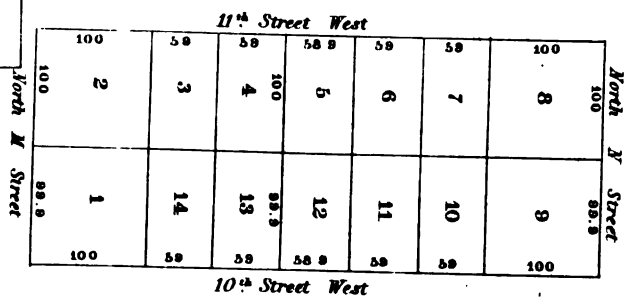





**SQUARE N° 343**

**SQUARE N° 344**

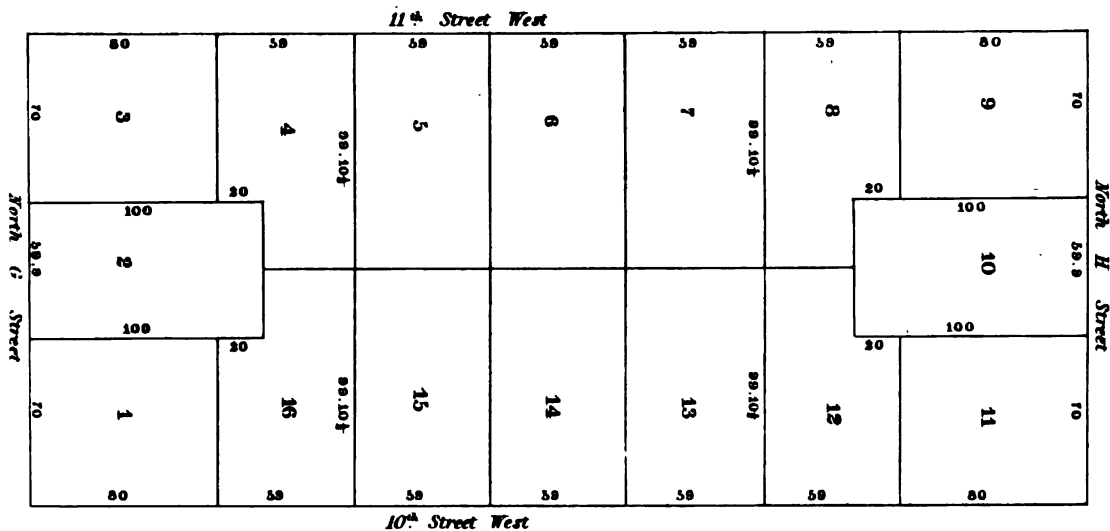
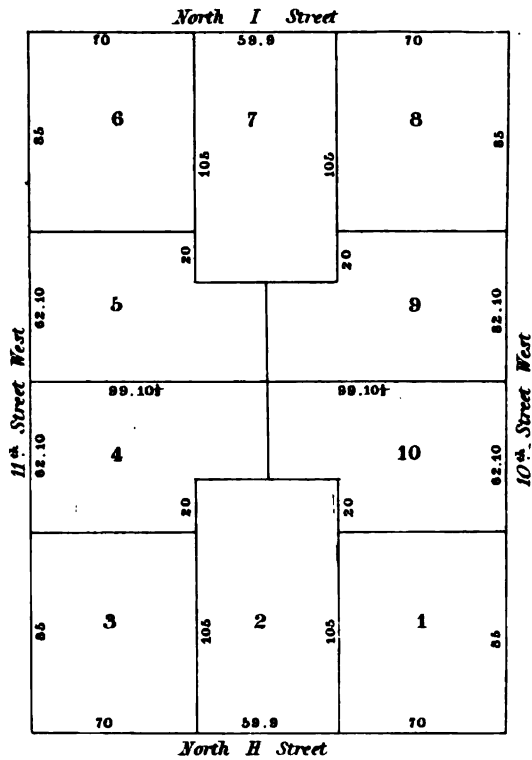
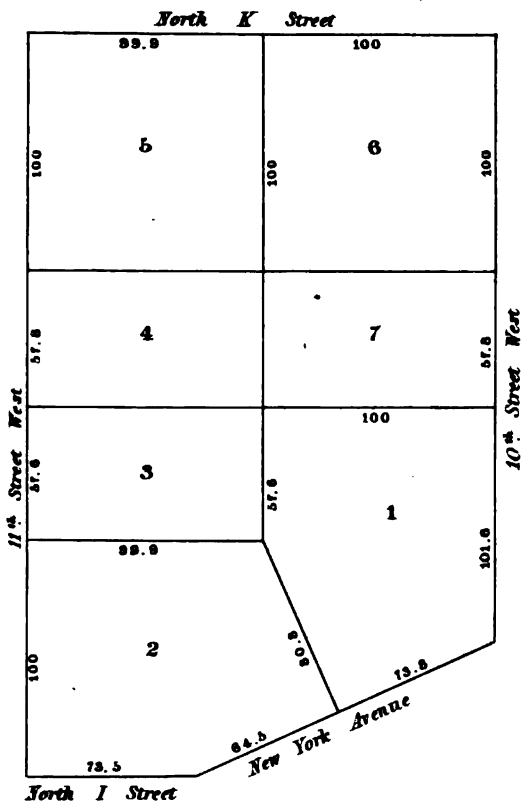

**SQUARE N° 345**

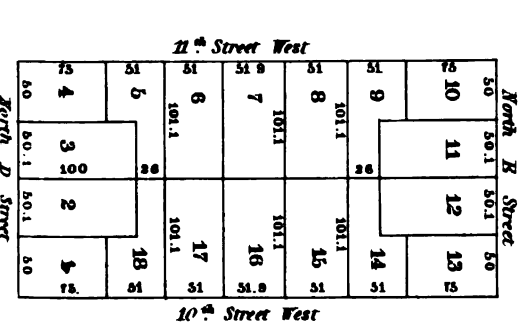

**SQUARE N° 346**

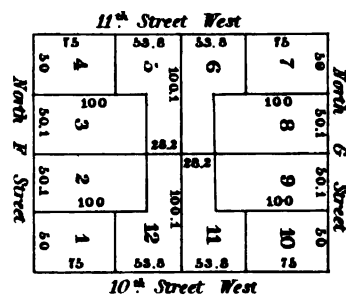

**SQUARE N° 347**

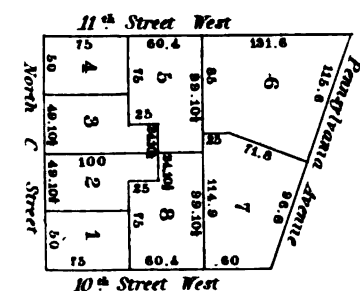

**SQUARE N° 348**

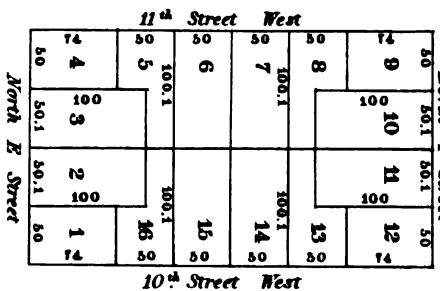

**SQUARE N° 349**



**SQUARE N°350**

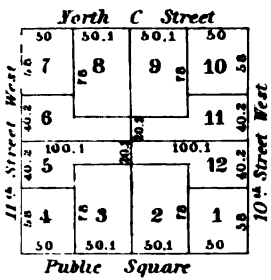

**SQUARE N. OF N°351**

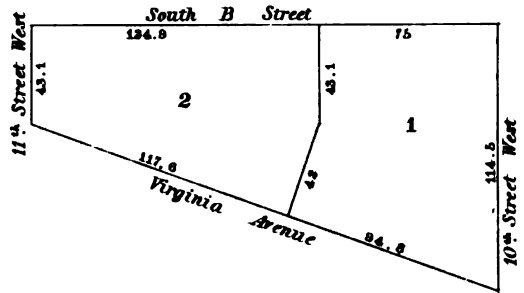

**SQUARE N°351**

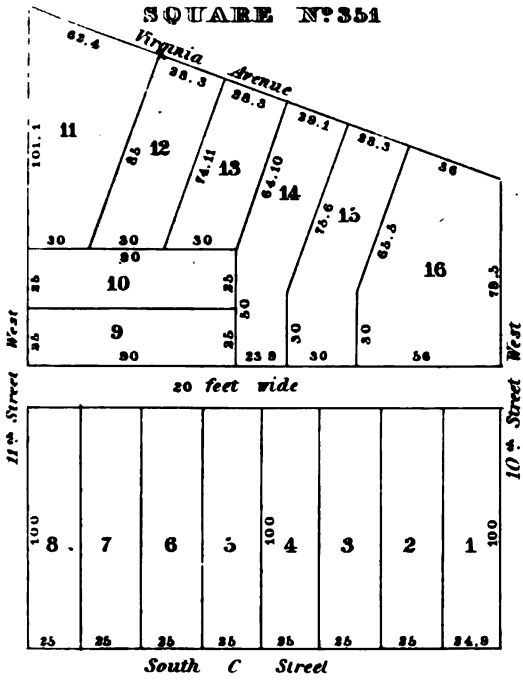

**SQUARE N°352**

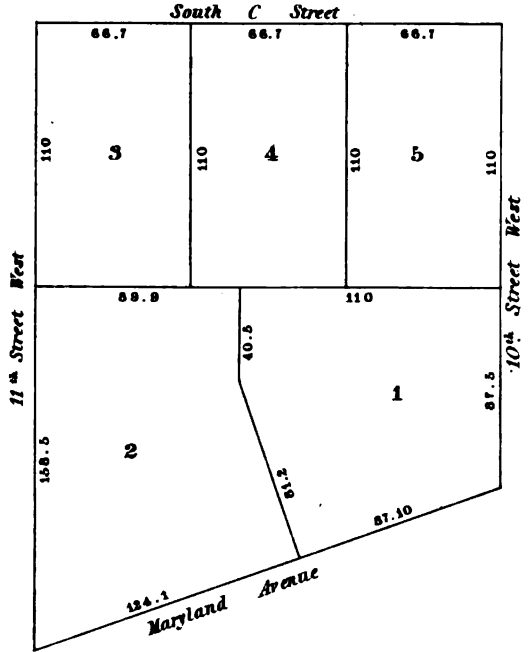

**11th Street West**

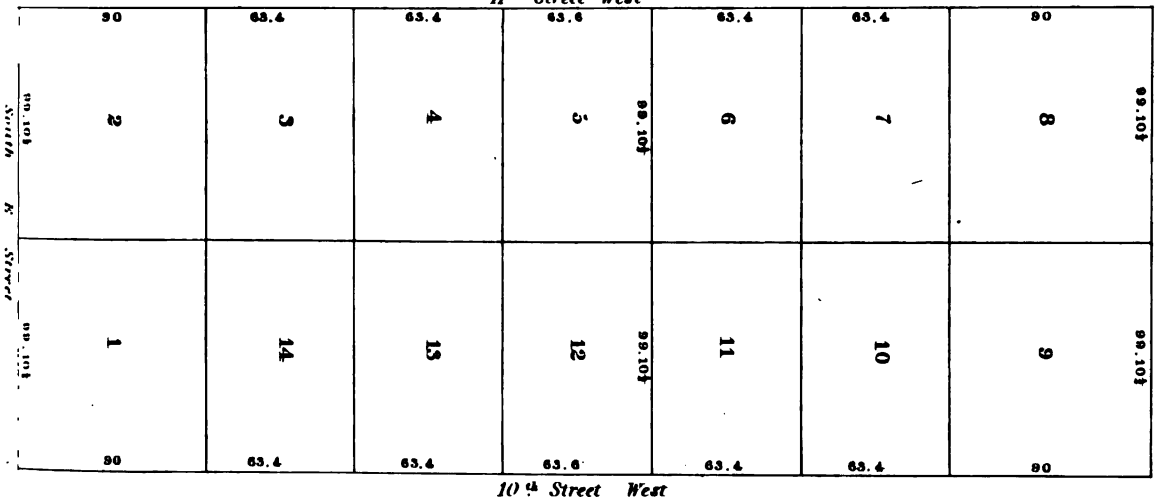

**SQUARE N°353**

**SQUARE N°354**

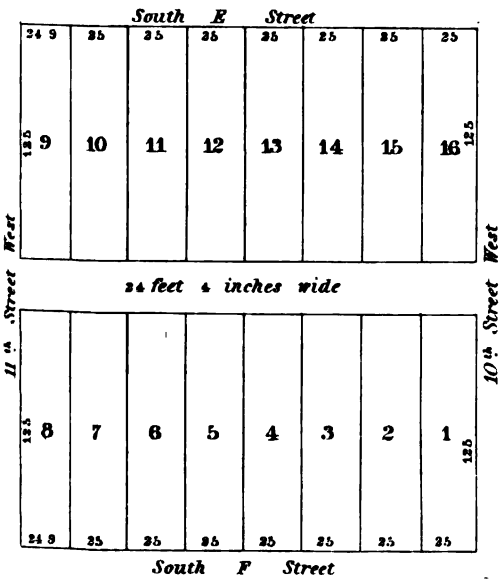

**SQUARE N°355**

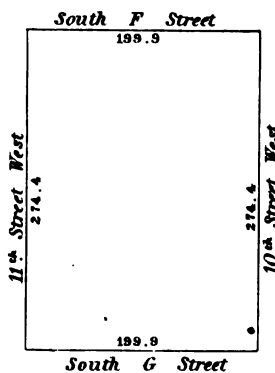

**SQUARE N°356**

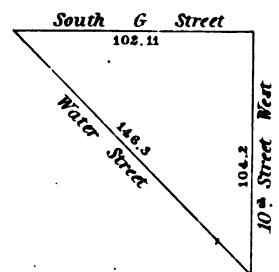



**SQUARE N:359**

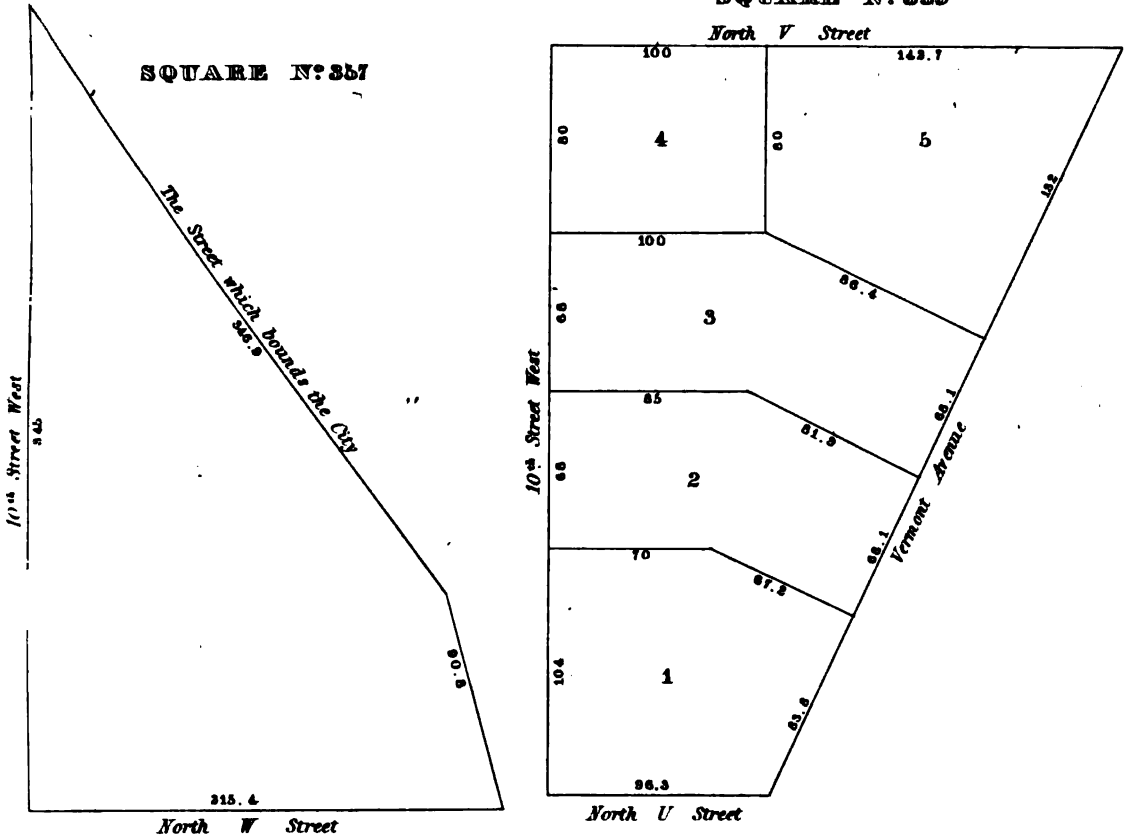

**SQUARE N:361**

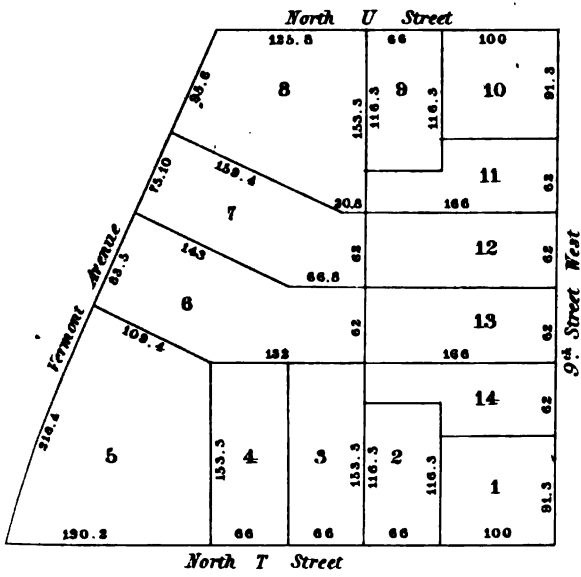

**SQUARE N:358**

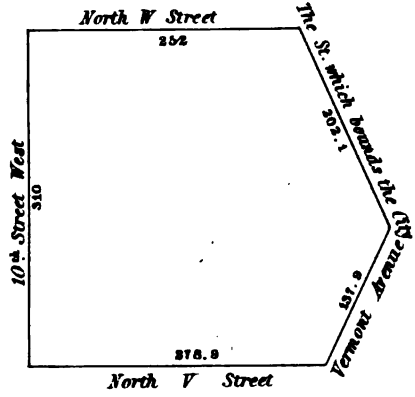

**SQUARE N:360**

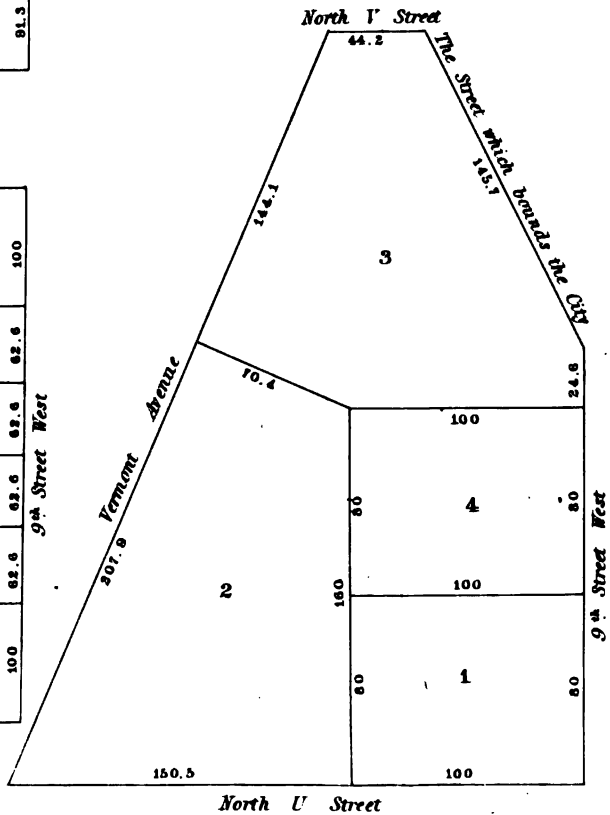

**SQUARE N:362**

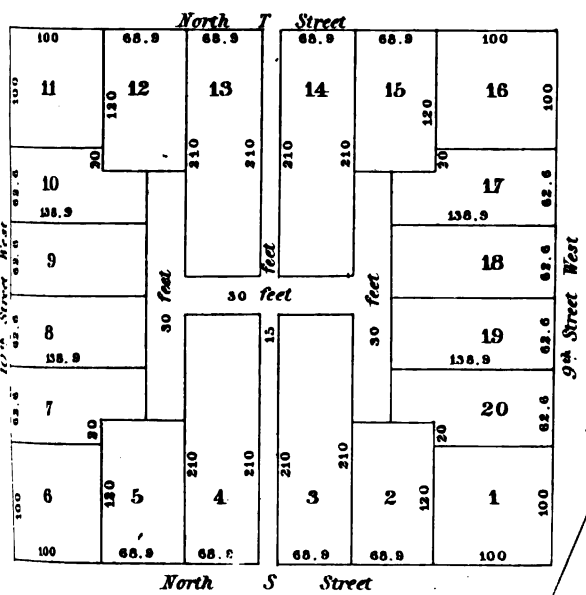



SQUARE N:363

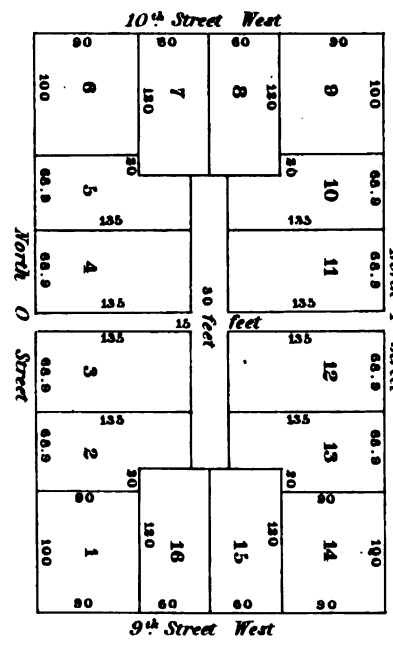
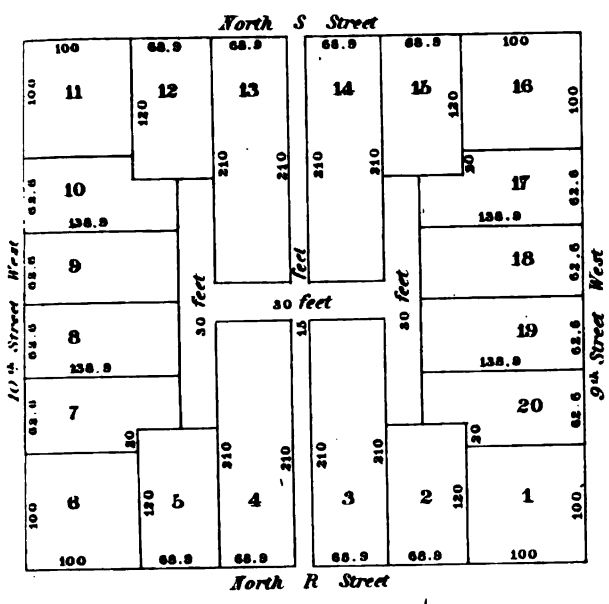

SQUARE N:366

SQUARE N:364

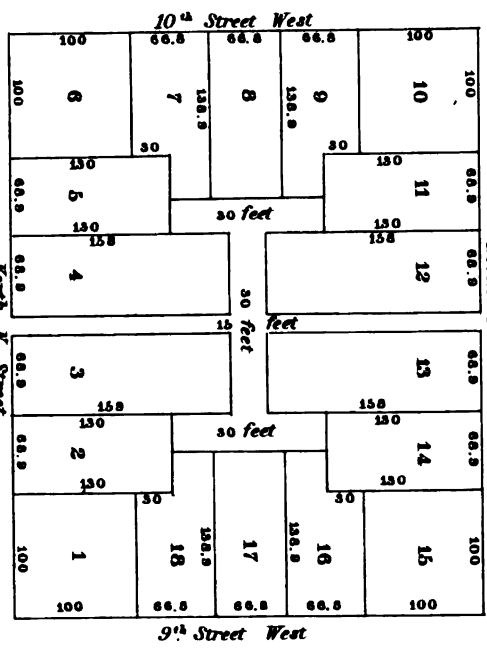
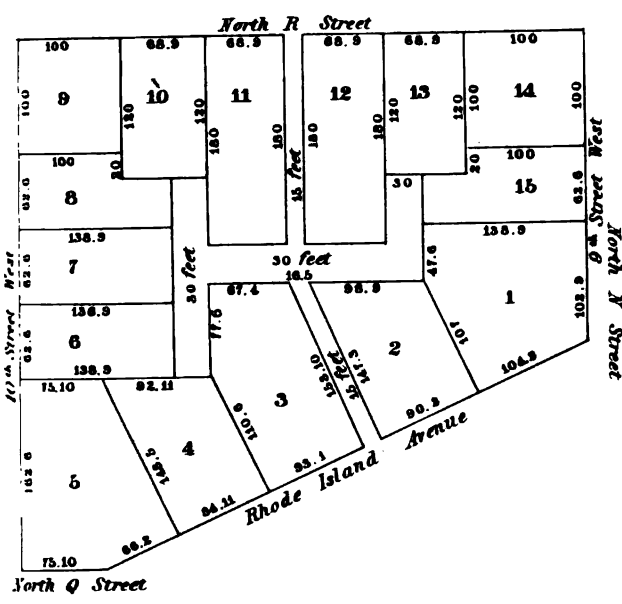

SQUARE N:367

SQUARE N:365

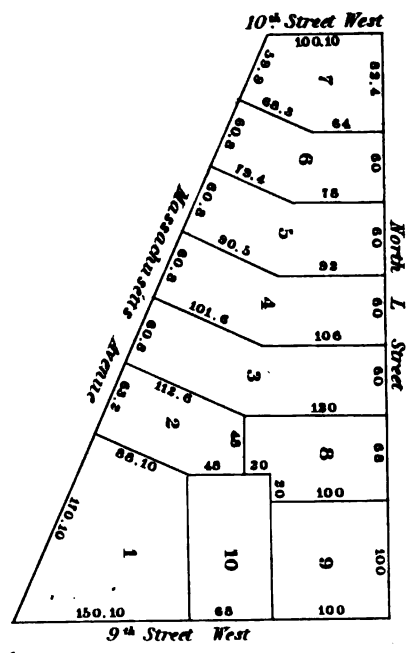
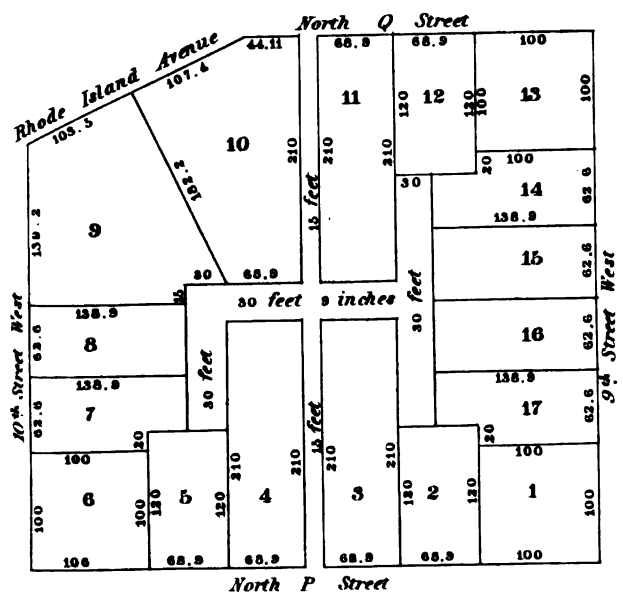

SQUARE N:310





SQUARE N:368

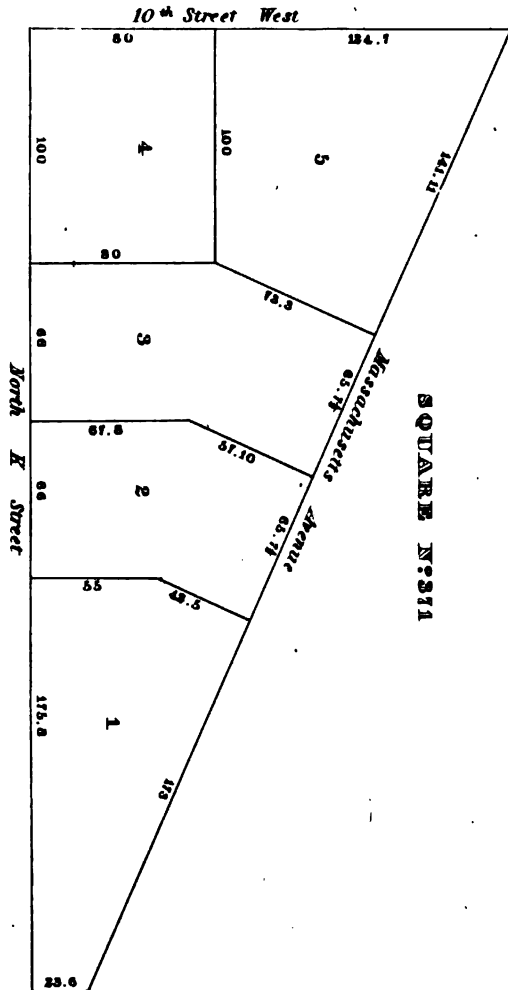
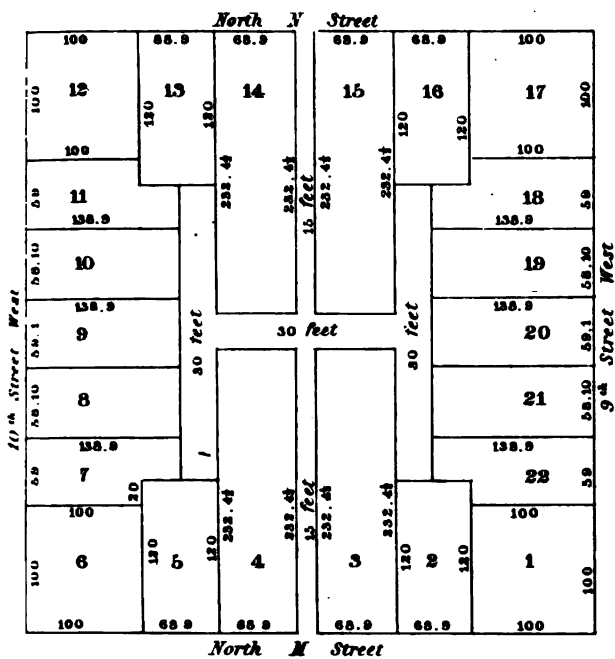

SQUARE N:369

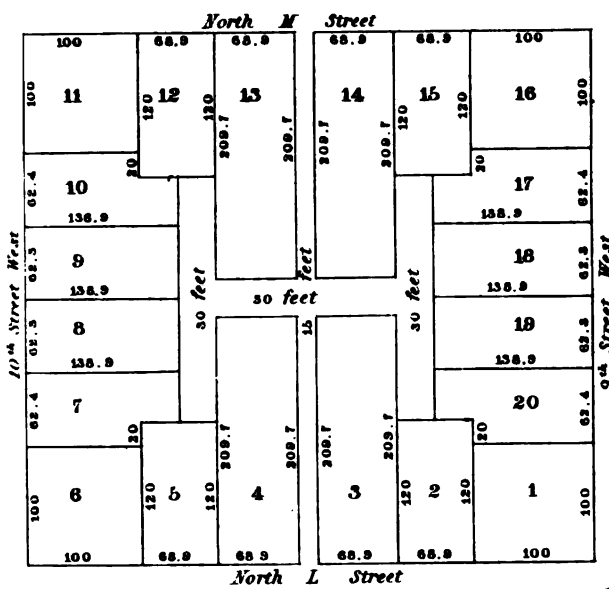

SQUARE N:373

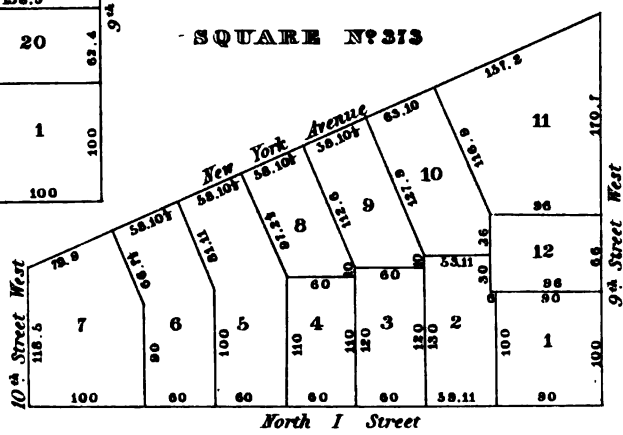

SQUARE N:372

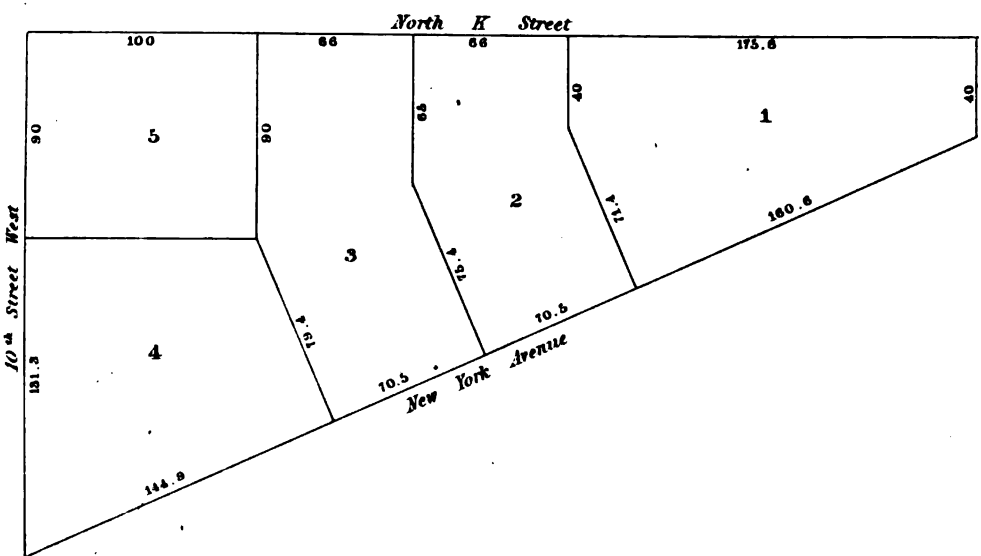



**SQUARE N°374**

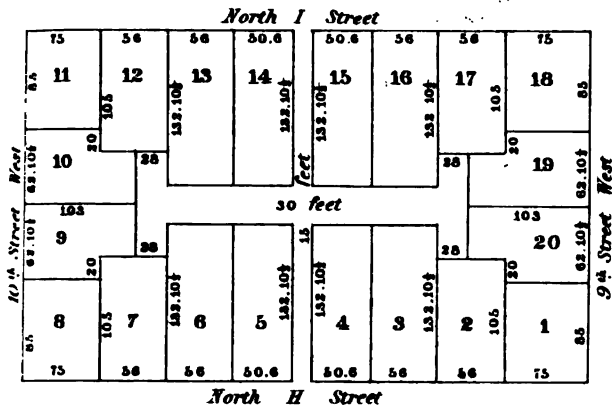

**SQUARE N°315**

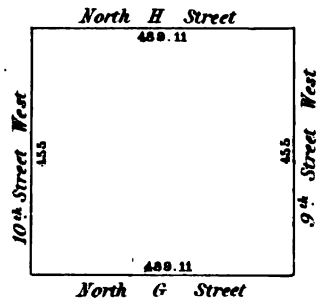

**SQUARE N°376**

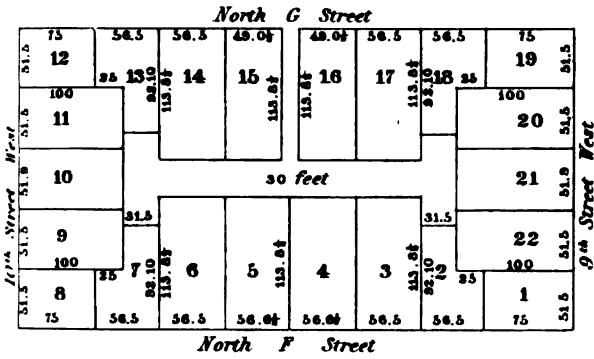

**SQUARE N°377**

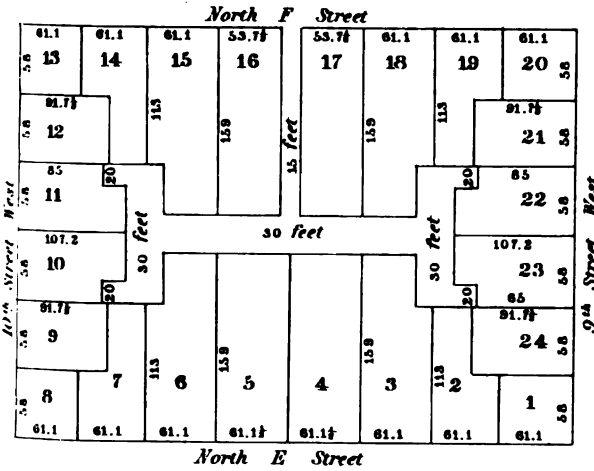

**SQUARE N°378**

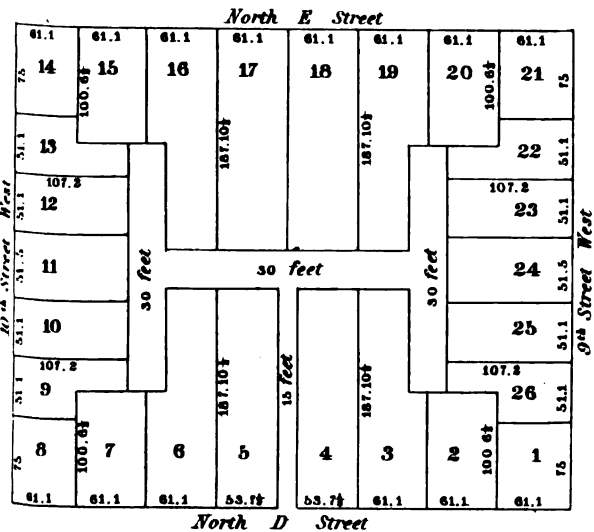

**10th St. West**

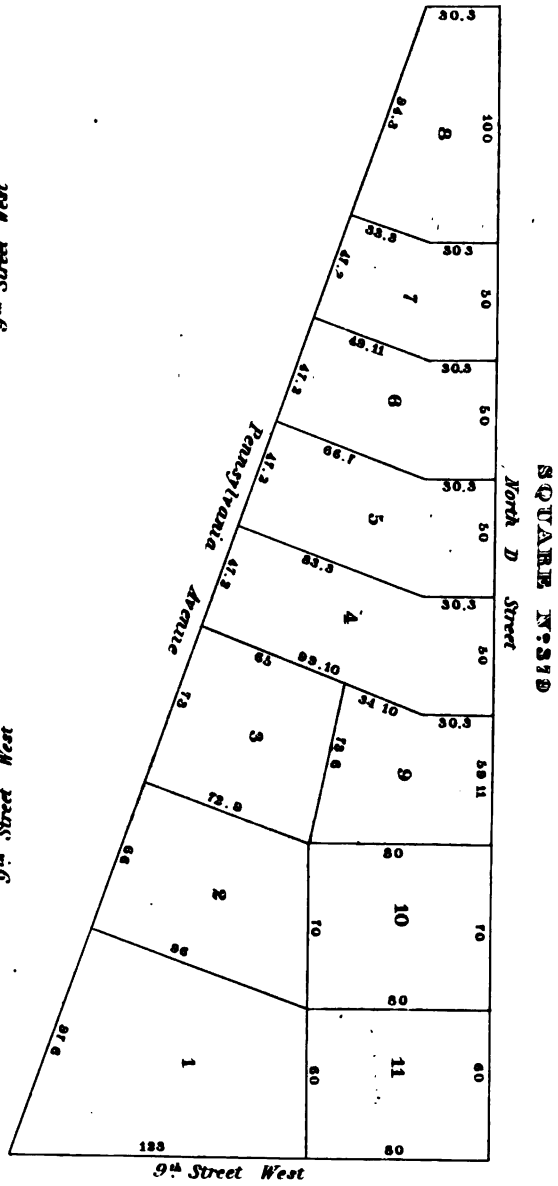

**SQUARE N°319**

**SQUARE N°383**

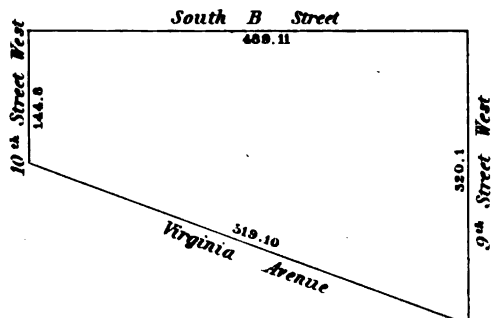



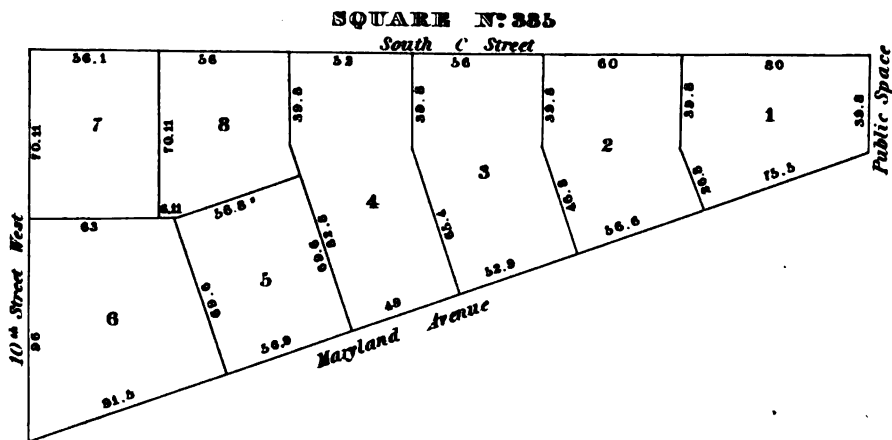
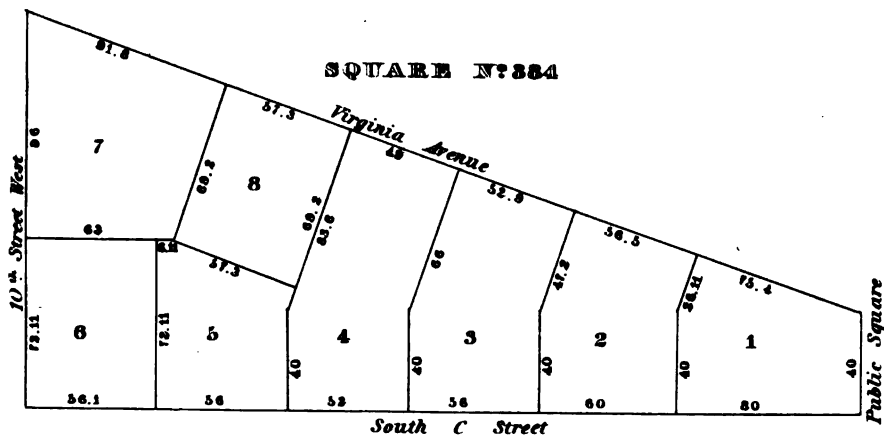
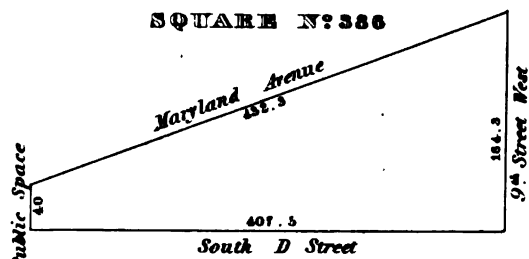
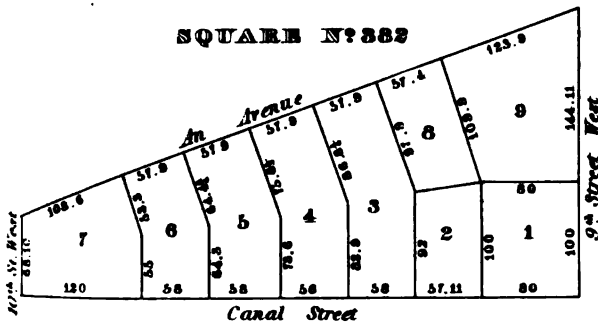
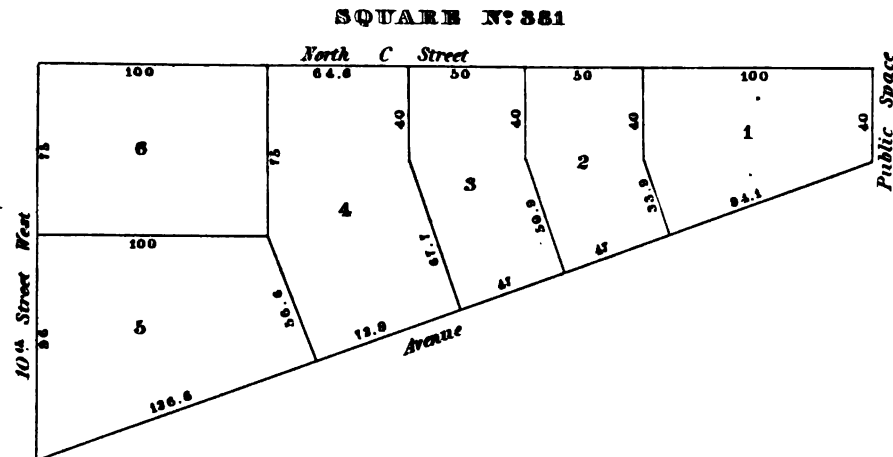
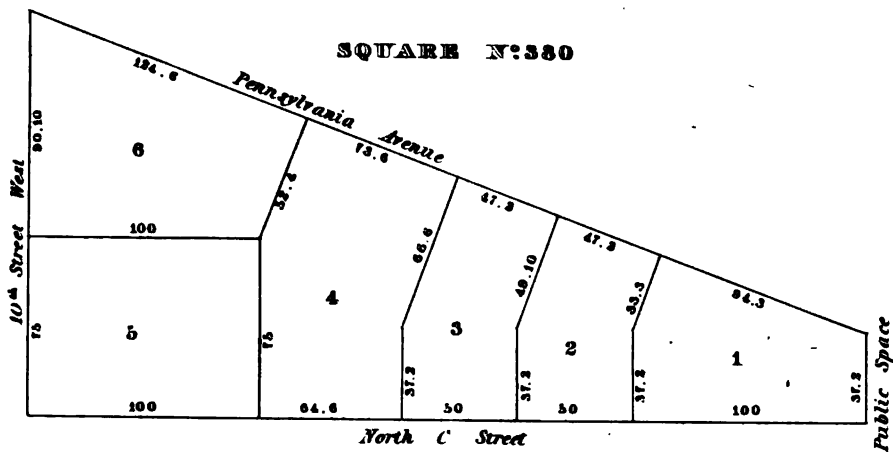

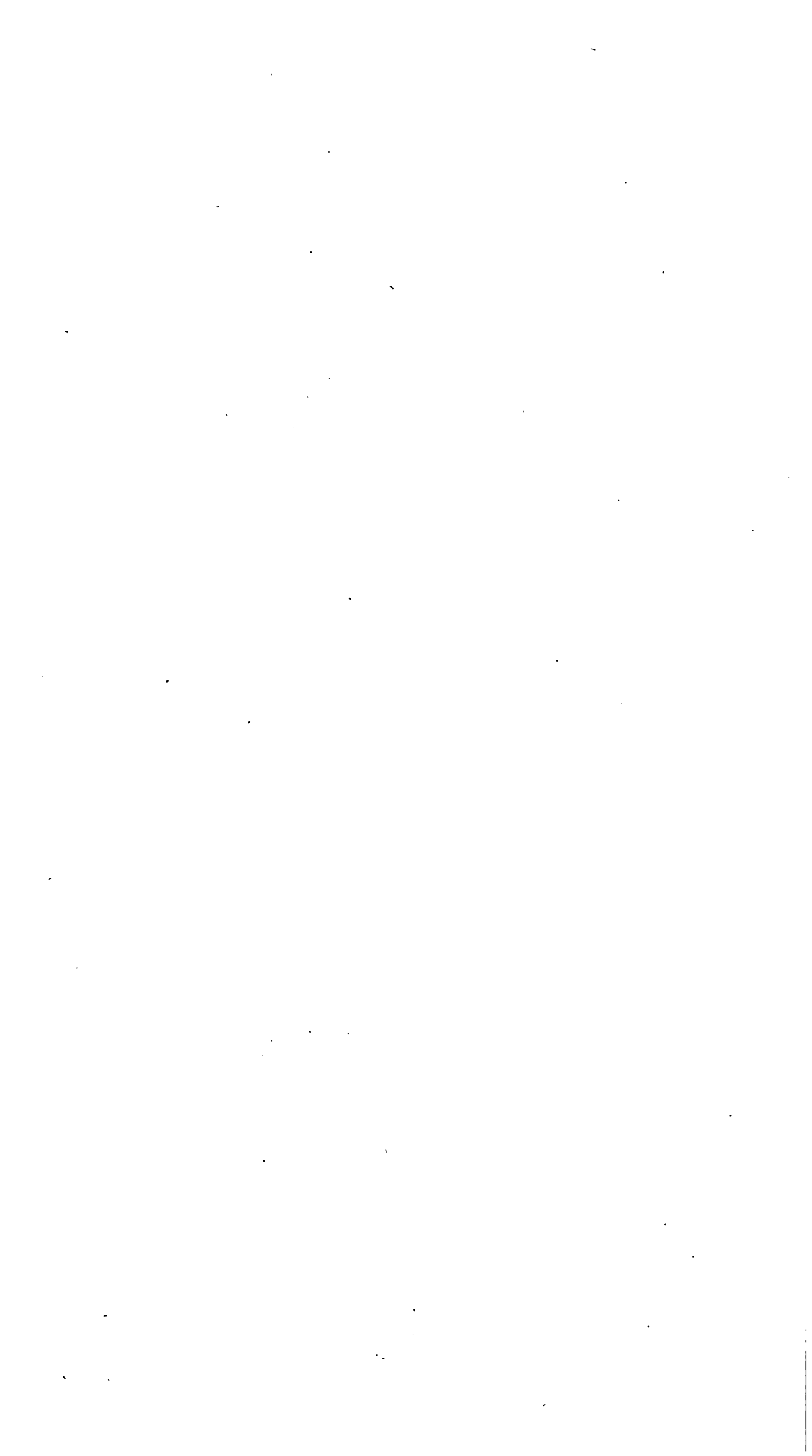

### SQUARE N° 387

South D Street

23	24	25	26	27	28	29	30	31	32	33	34	35	36	37	38	39	40
----	----	----	----	----	----	----	----	----	----	----	----	----	----	----	----	----	----

30 feet wide

21	22	23	24	25	26	27	28	29	30	31	32	33	34	35	36	37	38	39	40
----	----	----	----	----	----	----	----	----	----	----	----	----	----	----	----	----	----	----	----

30 feet wide

19	18	17	16	15	14	13	12	11	10	9	8	7	6	5	4	3	2	1
----	----	----	----	----	----	----	----	----	----	---	---	---	---	---	---	---	---	---

South E Street

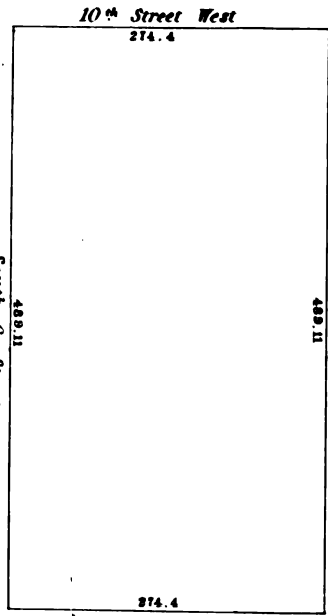

SQUARE N° 389

South F Street

South G Street

### SQUARE N° 388

South E Street

20	21	22	23	24	25	26	27	28	29	30	31	32	33	34	35	36	37	38
----	----	----	----	----	----	----	----	----	----	----	----	----	----	----	----	----	----	----

24 feet 4 inches wide

19	18	17	16	15	14	13	12	11	10	9	8	7	6	5	4	3	2	1
----	----	----	----	----	----	----	----	----	----	---	---	---	---	---	---	---	---	---

South F Street

### SQUARE N° 389

South G Street

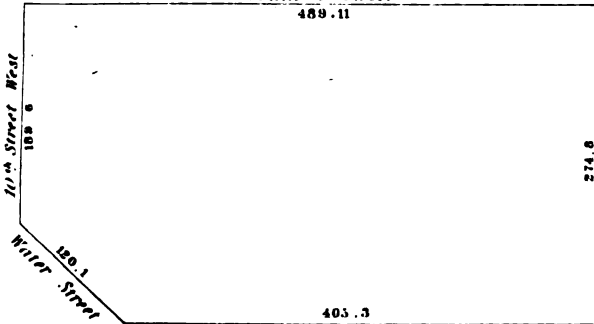

SQUARE N° 391

South H Street

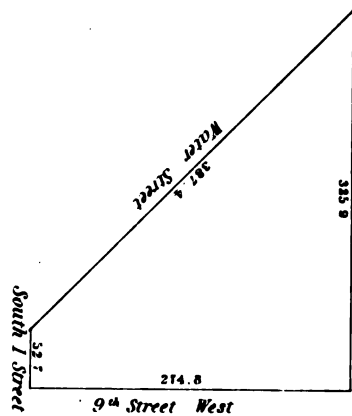

### SQUARE N° 390

South G Street

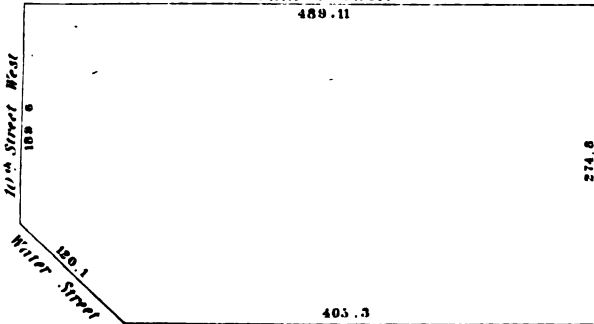

SQUARE N° 393

2	3	4	5	6	7	8	9	10
---	---	---	---	---	---	---	---	----

8th Street West

SQUARE N° 392

North P Street

2	3	4	5	6	7	8	9	10
---	---	---	---	---	---	---	---	----

8th Street West

The street which bounds the city



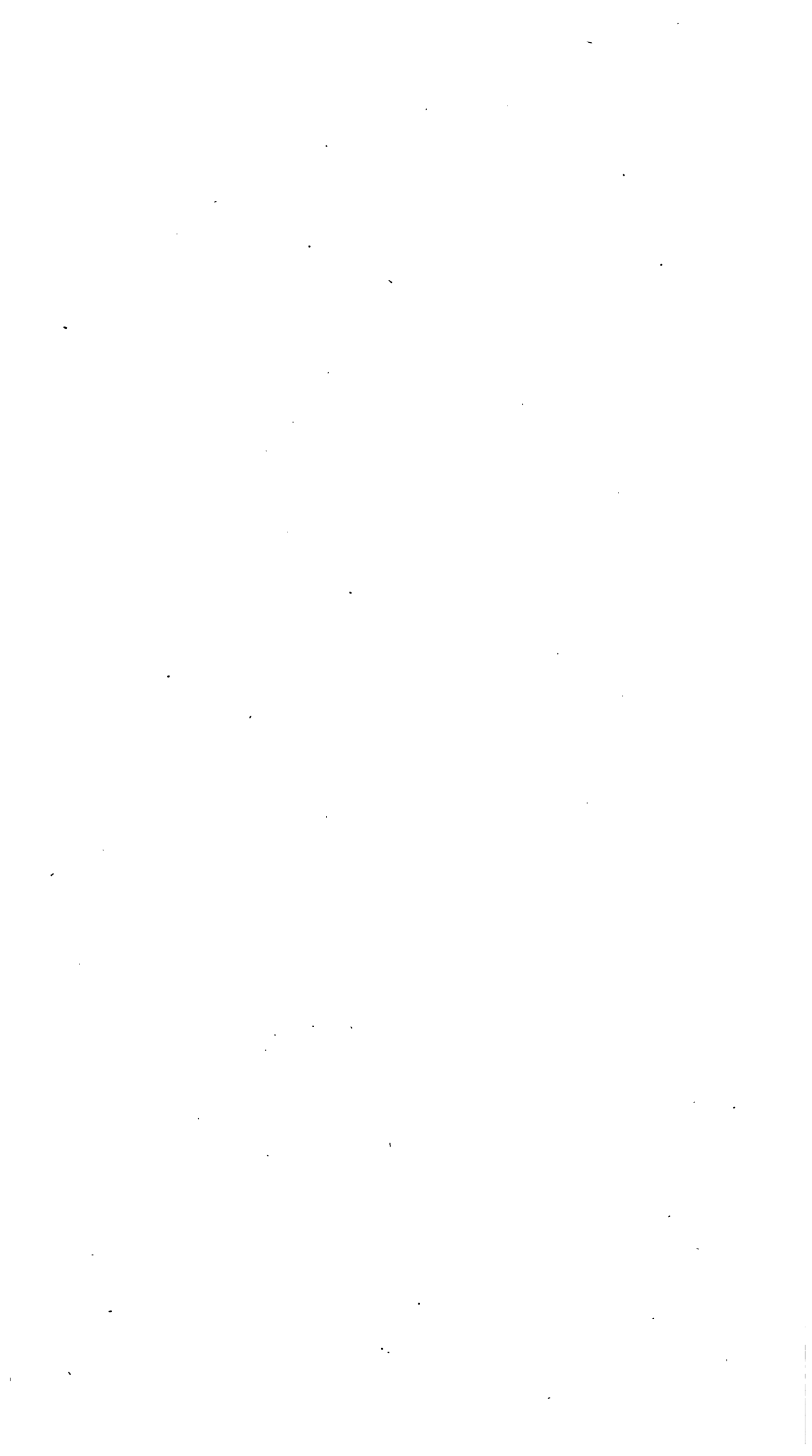

**SQUARE N°387**

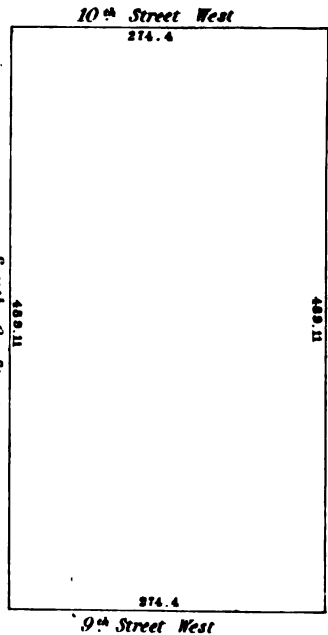
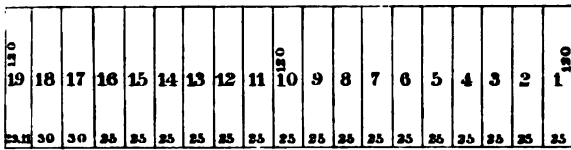
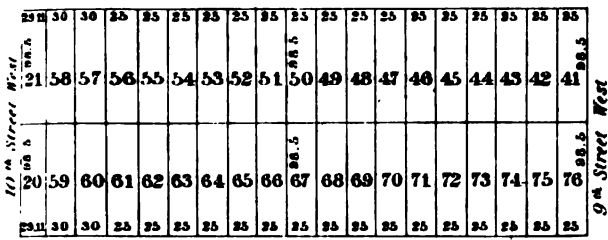
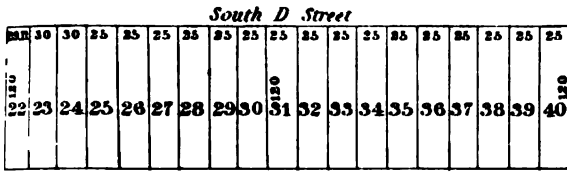

**SQUARE N°389**

**SQUARE N°388**

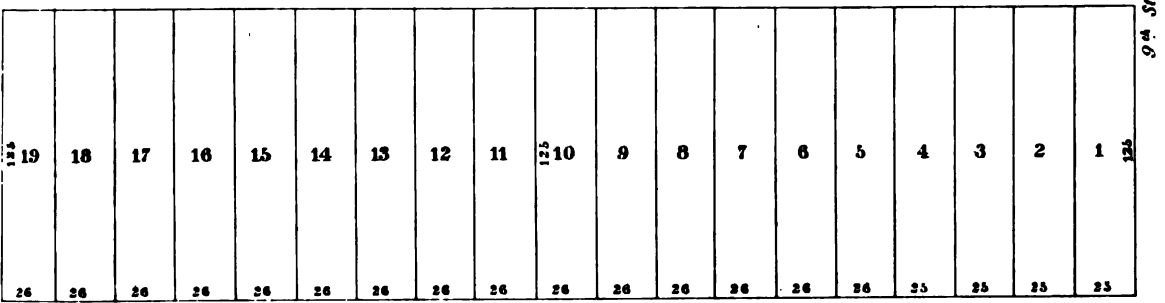
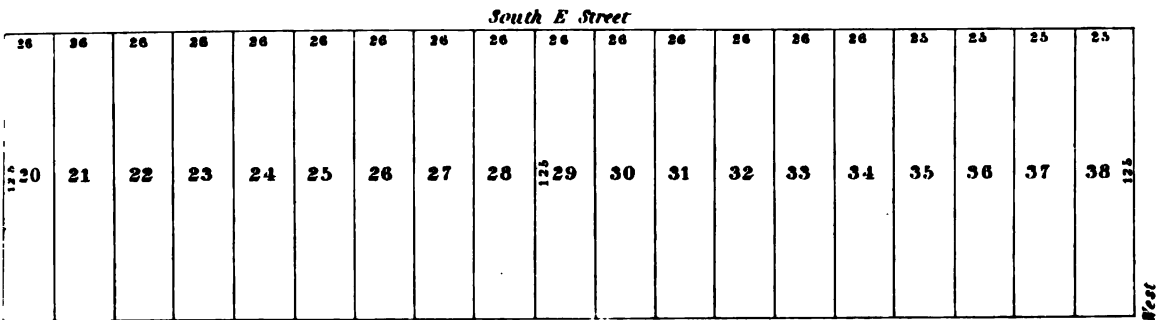

**SQUARE N°390**

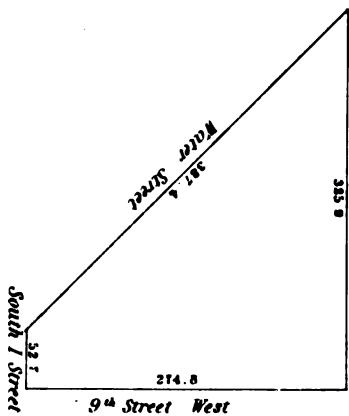
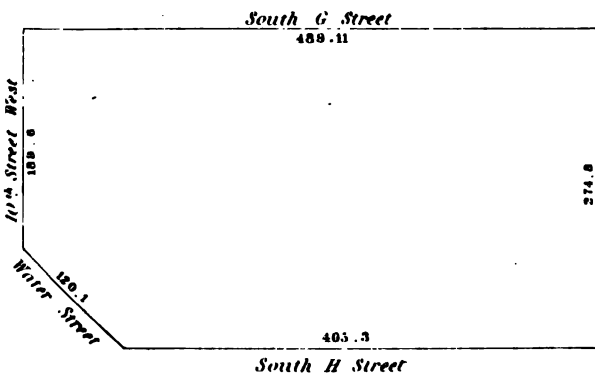

**SQUARE N°391**

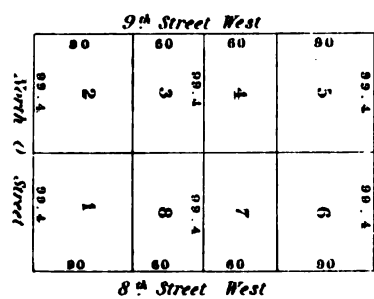

**SQUARE N°388**

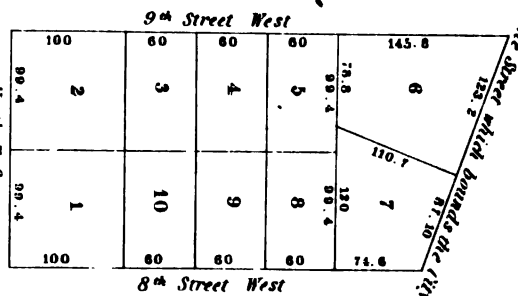

**SQUARE N°389**



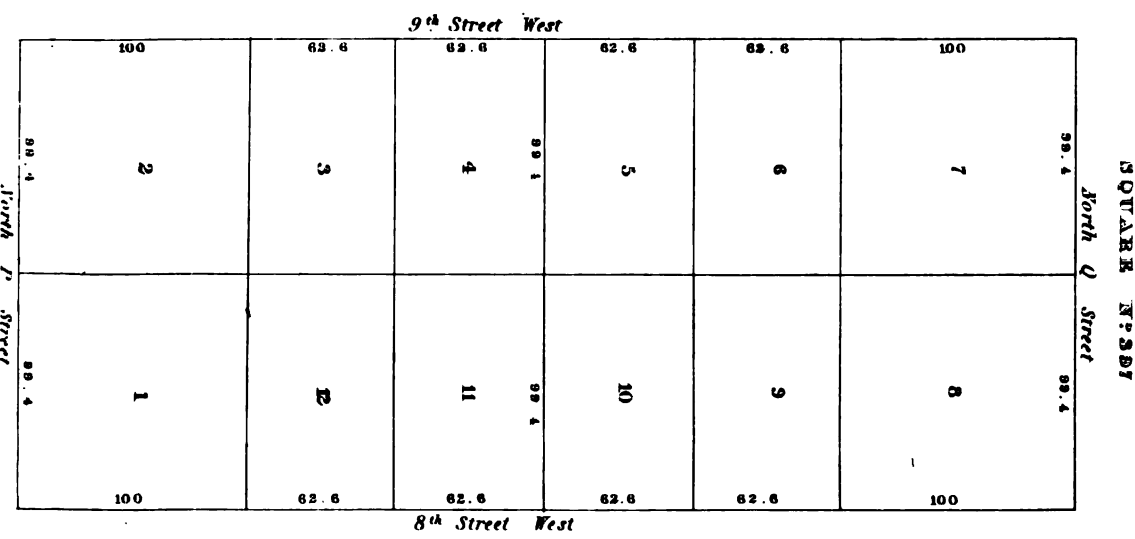
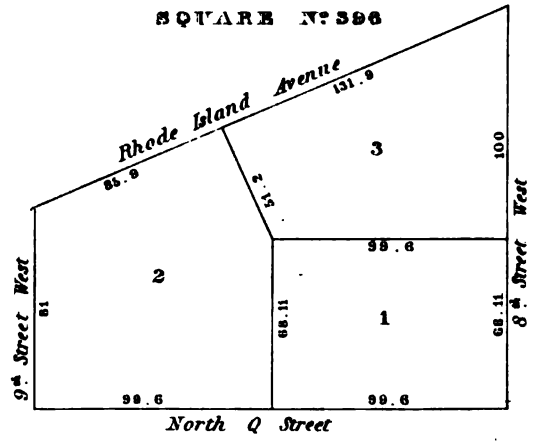
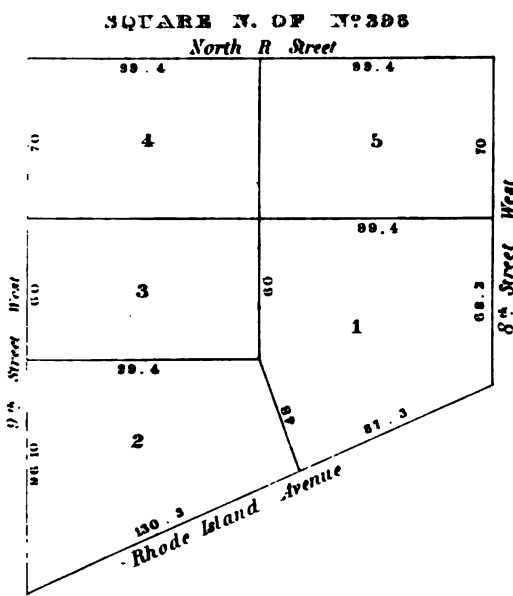
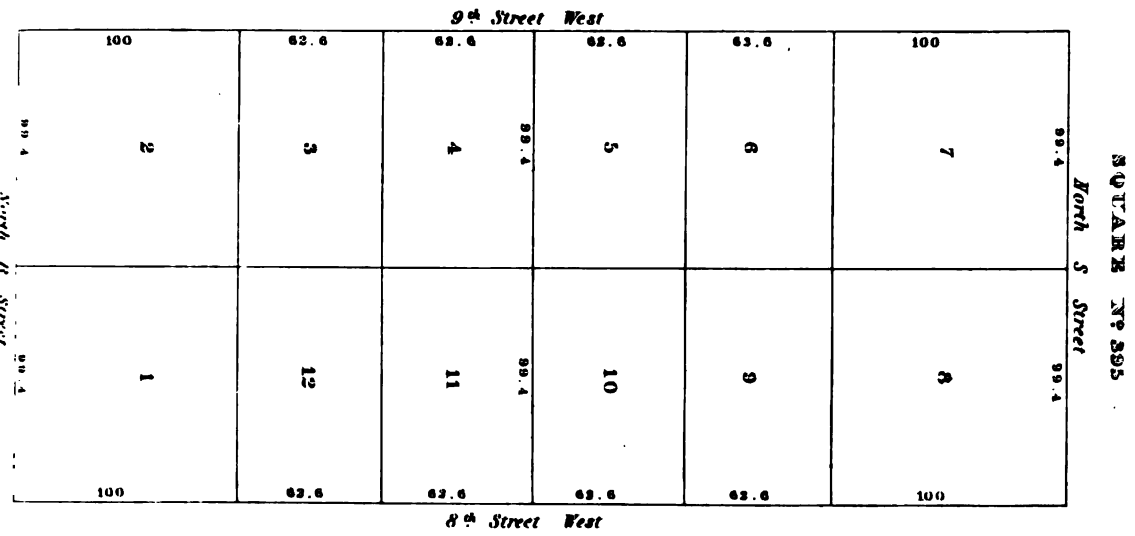
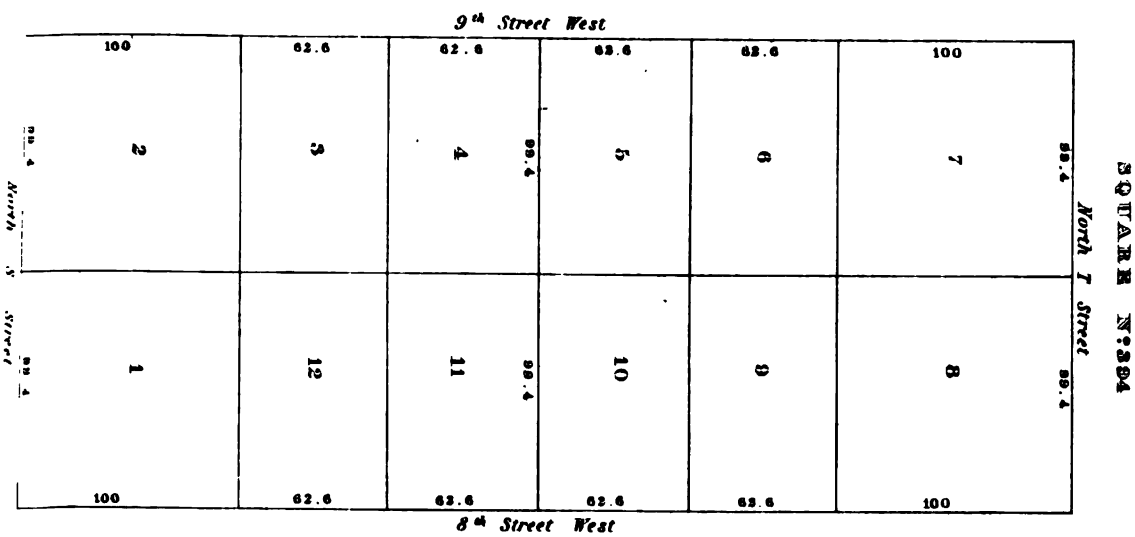







**SQUARE N:405**

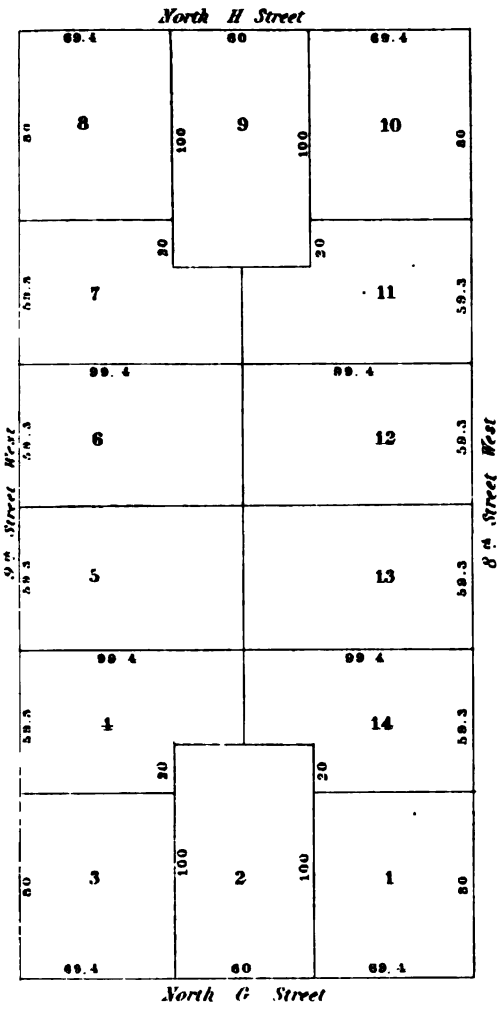

**SQUARE N:408**

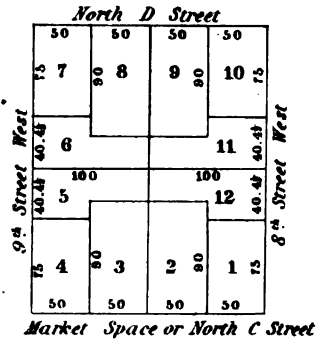

**SQUARE N:409**

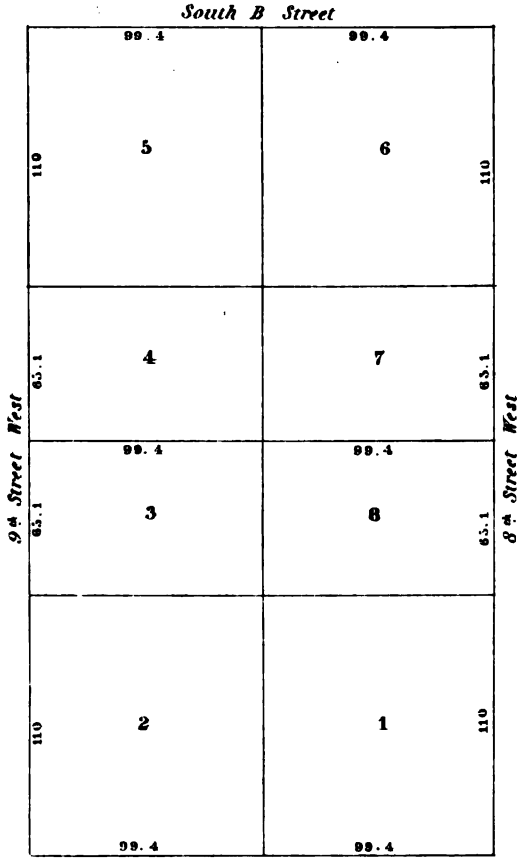

**SQUARE N:410**

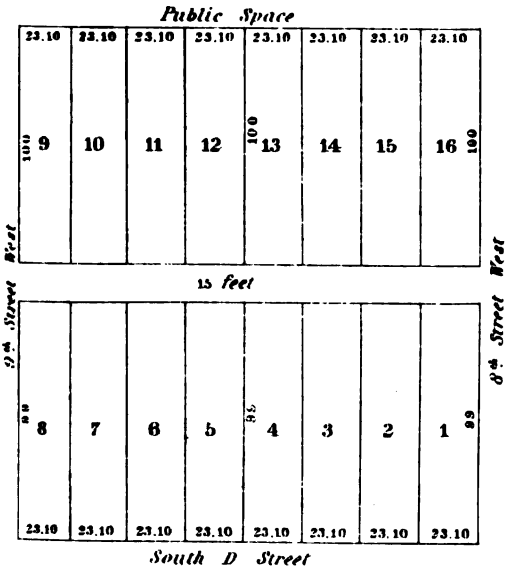

**SQUARE N:414**

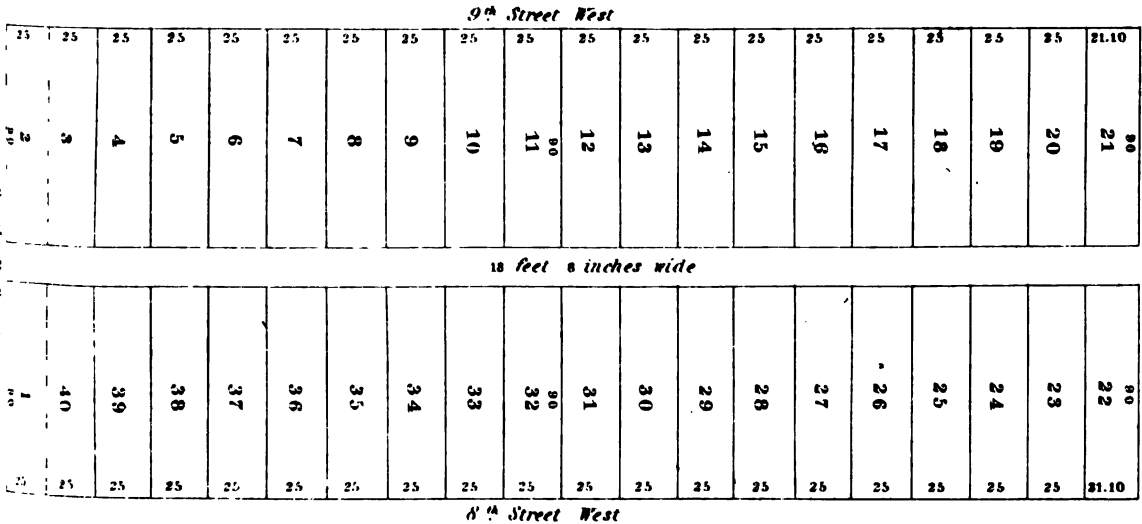
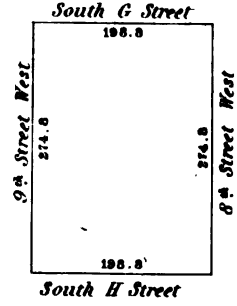

SQUARE N:411





SQUARE N: 412

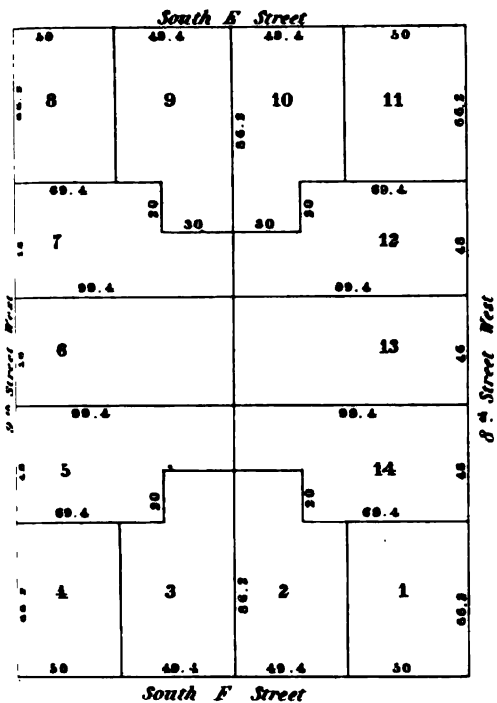

SQUARE N: 413

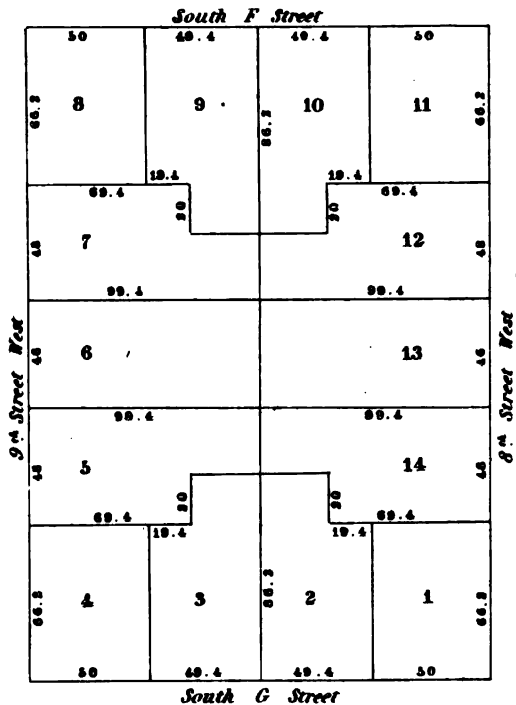

SQUARE N: 415

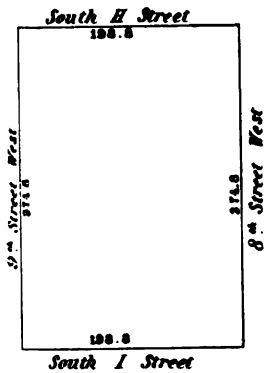

SQUARE S. OF N: 415

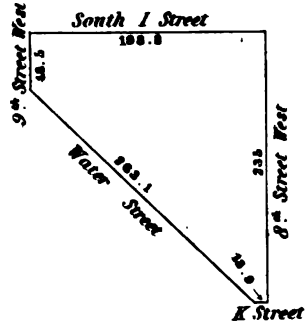

SQUARE N: 418

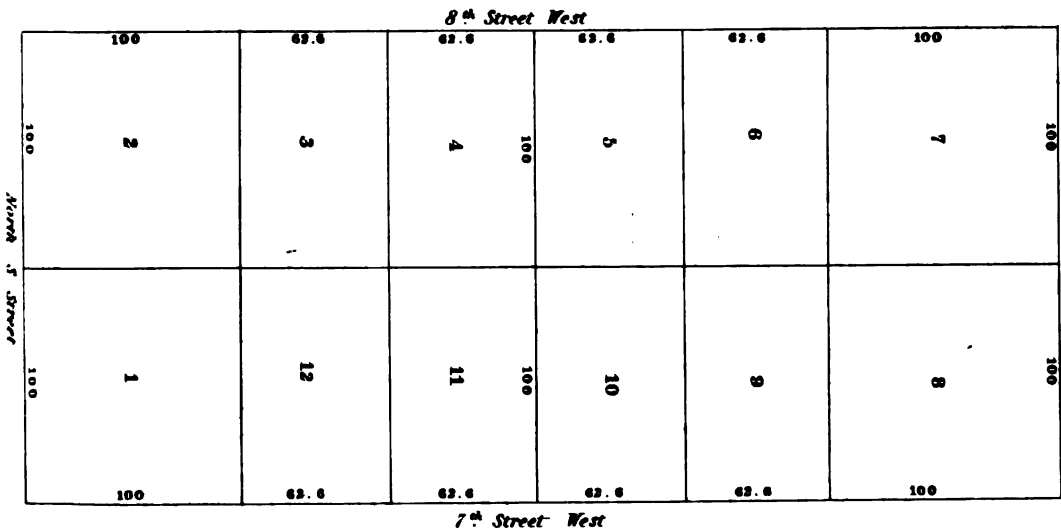
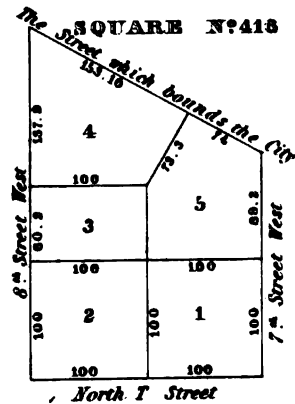

SQUARE N: 411

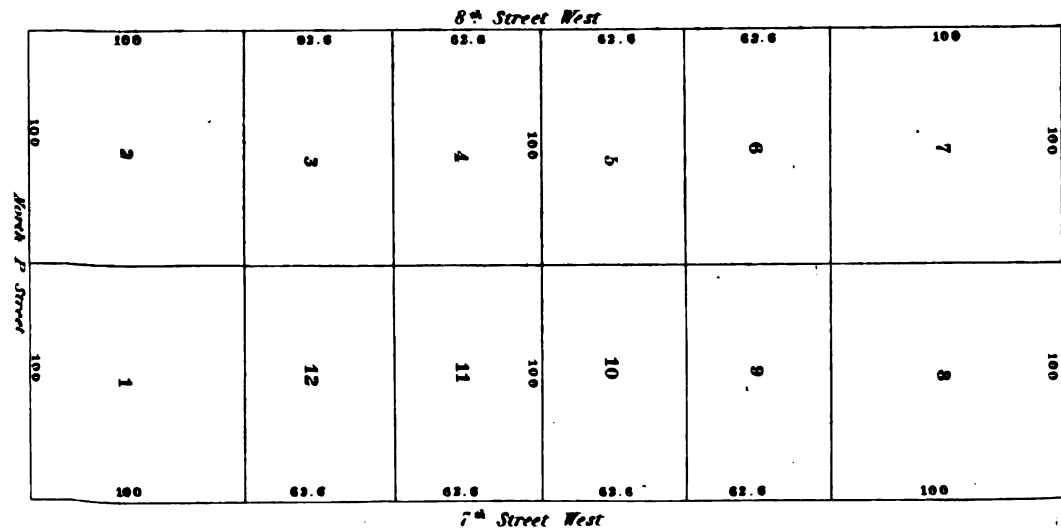

SQUARE N: 421



SQUARE N. OF N:490

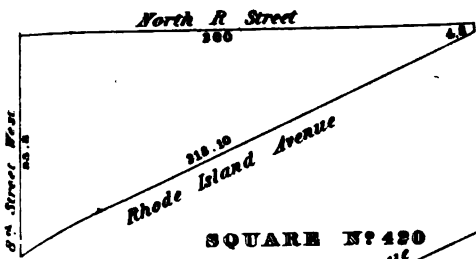

SQUARE N:490

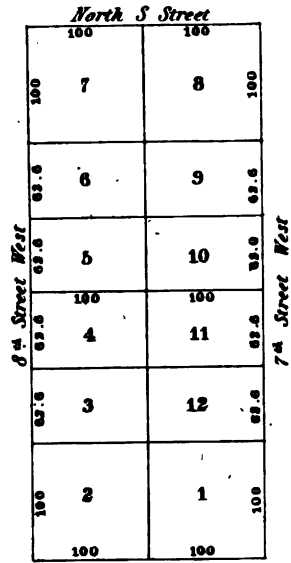
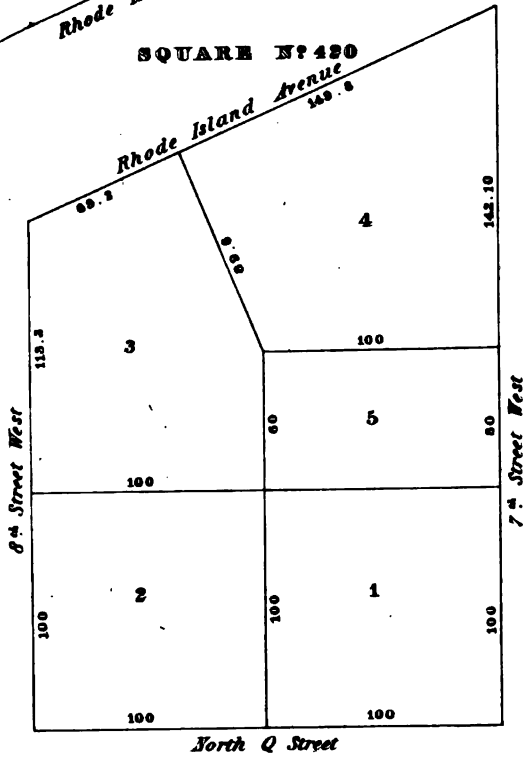

North R Street

SQUARE N: 422

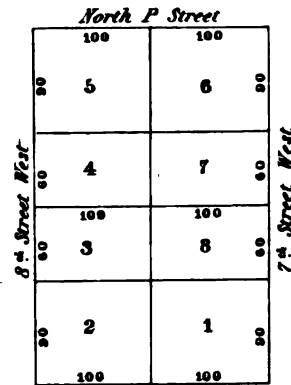

North O Street

SQUARE N:424

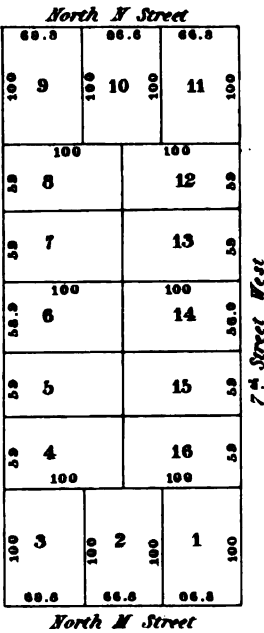

North M Street

SQUARE N: 425

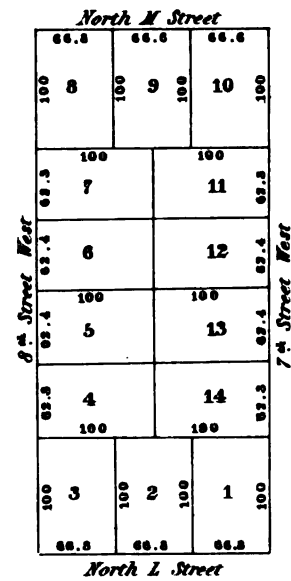

North L Street

SQUARE N:423

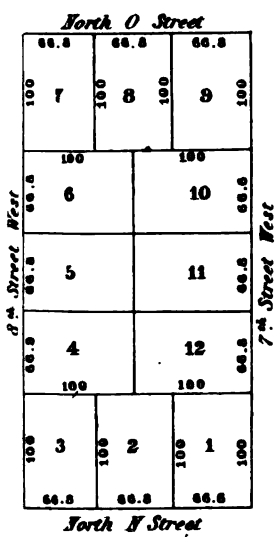

North H Street

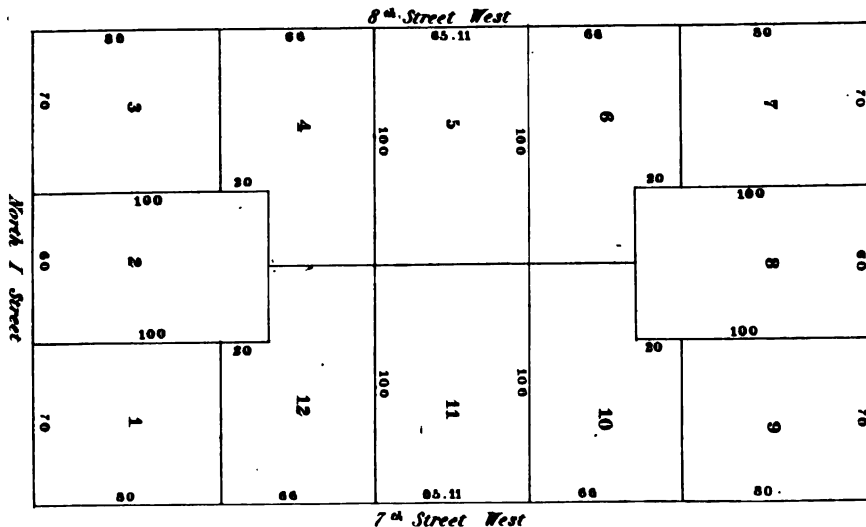

SQUARE N:427



SQUARE N° 428

SQUARE N° 428

SQUARE N° 430

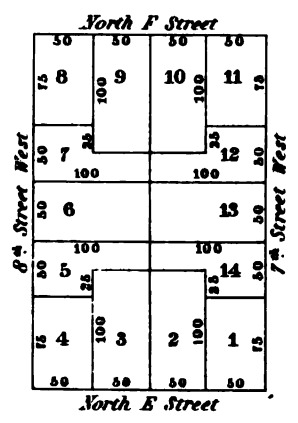
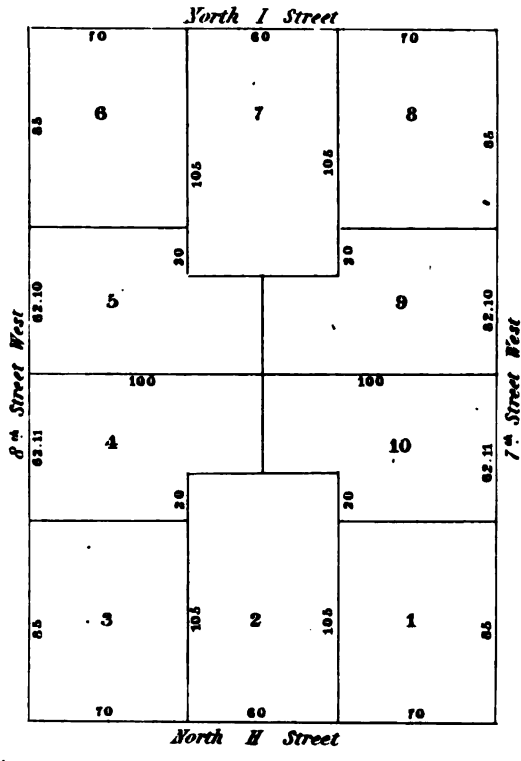
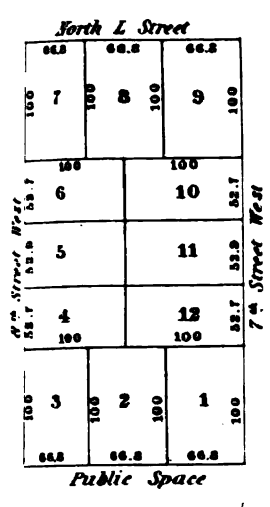

SQUARE N° 432

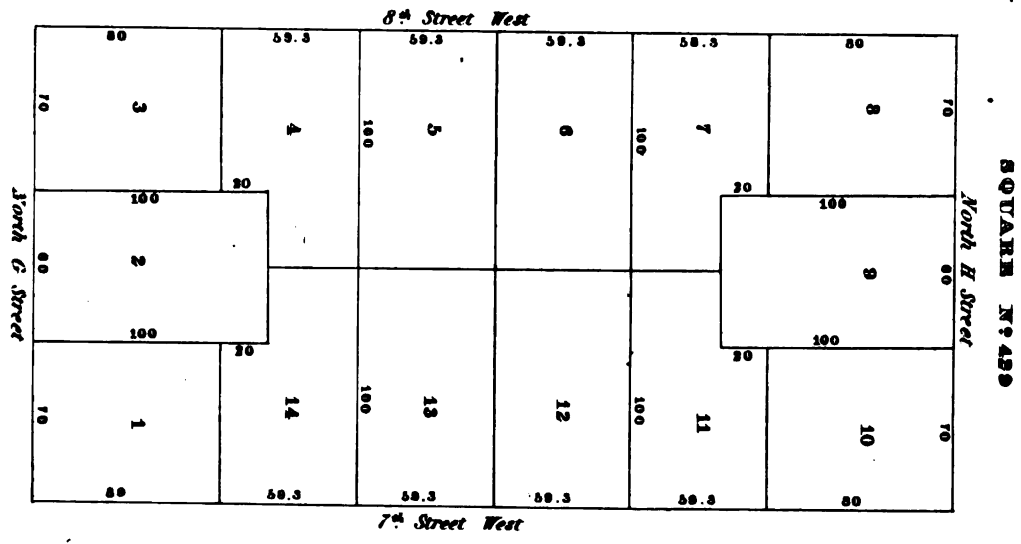
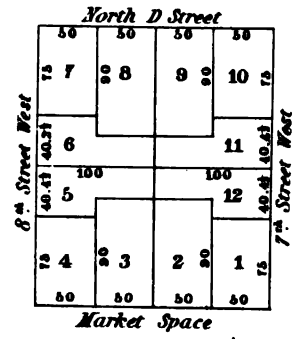

SQUARE N° 433

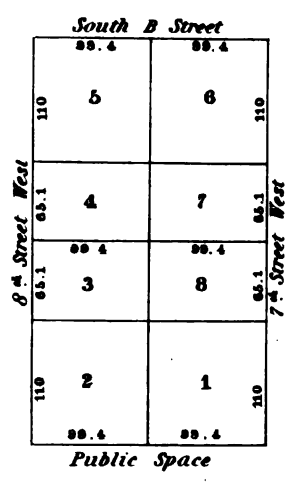

SQUARE N° 434

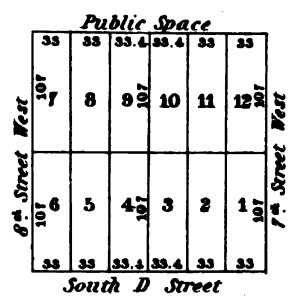

SQUARE N° 431

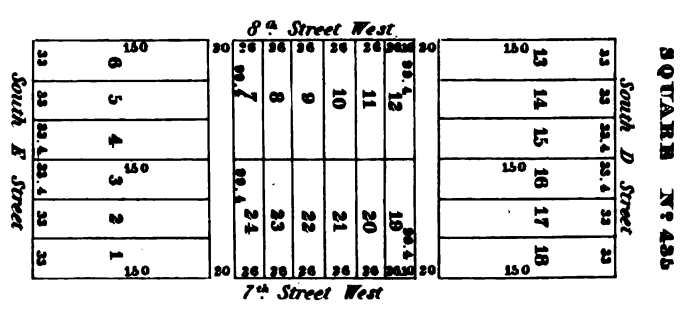
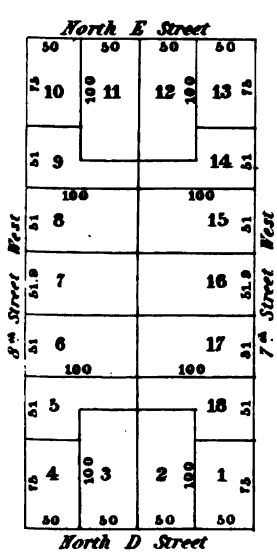

SQUARE N° 435

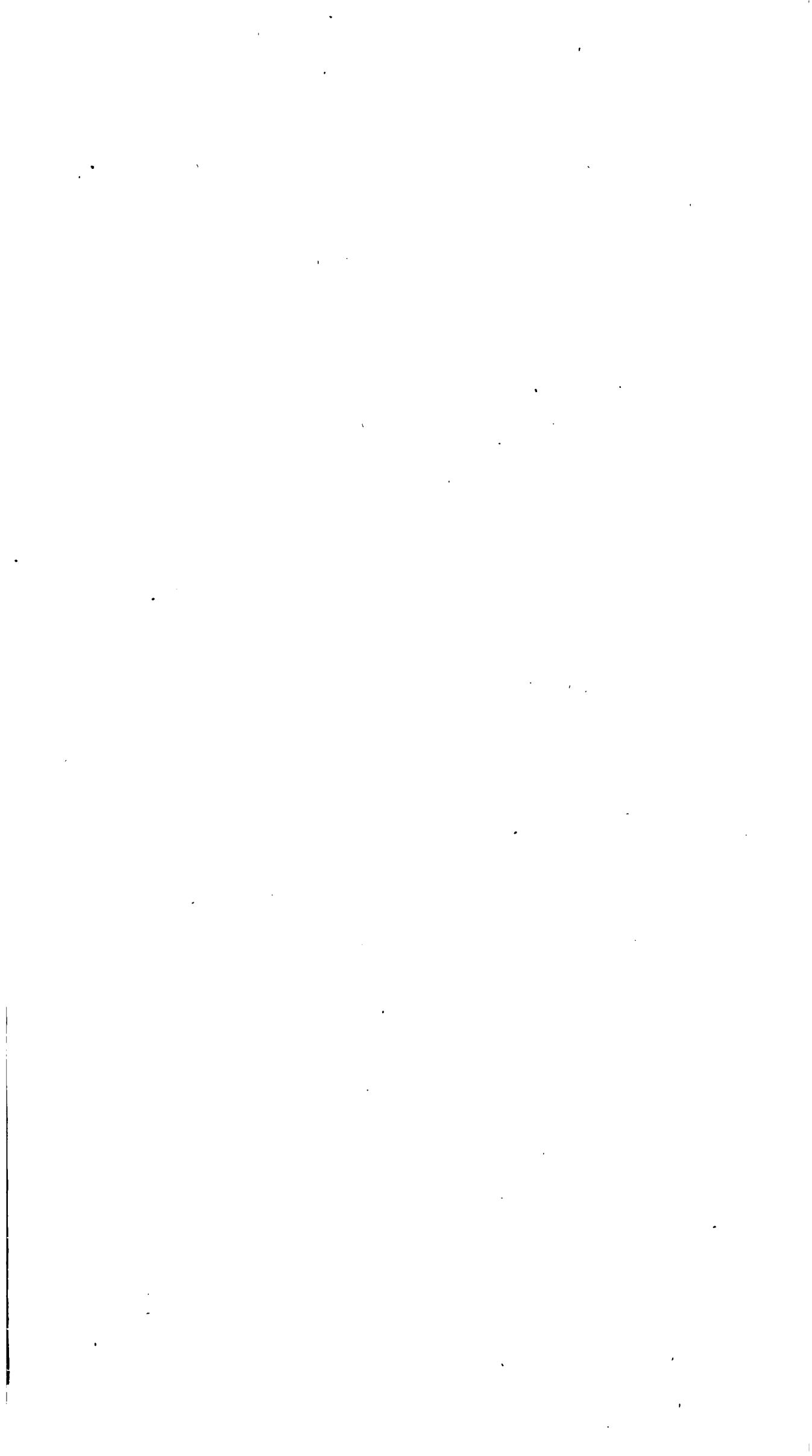

SQUARE N:438

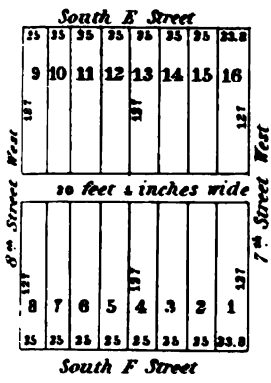

SQUARE N:431

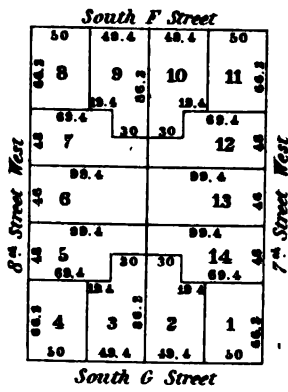

SQUARE N:438

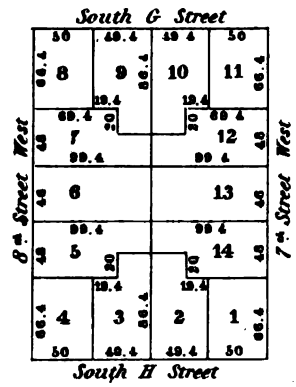

SQUARE N:439

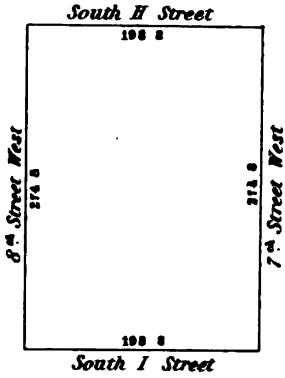

SQUARE S. OF N:439

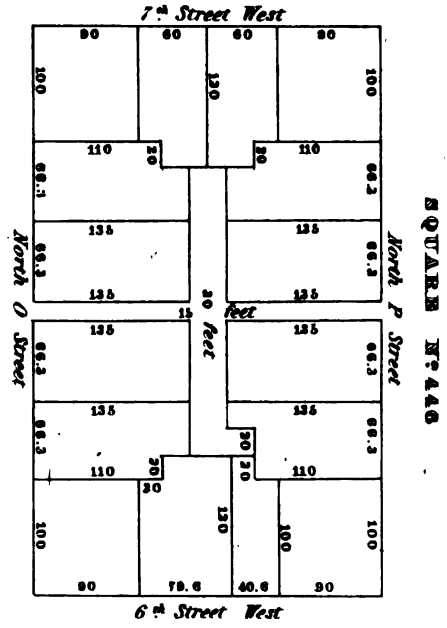
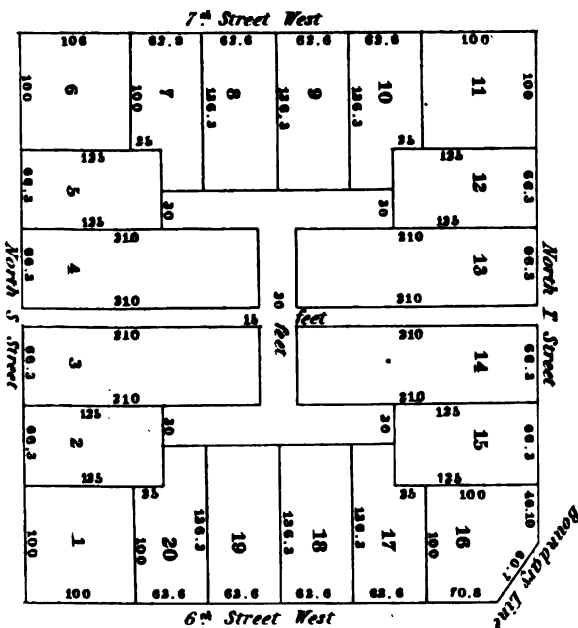
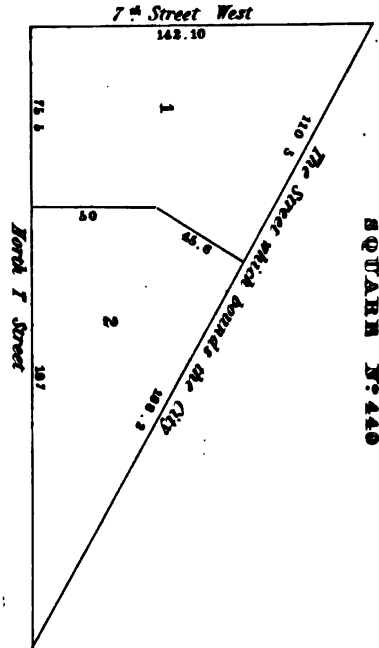
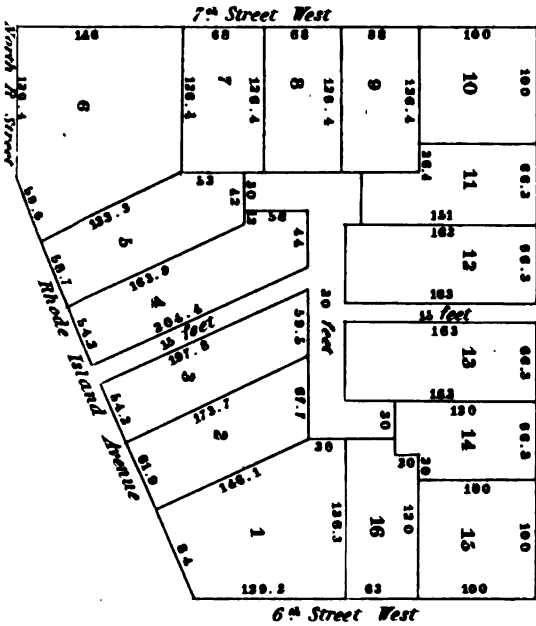
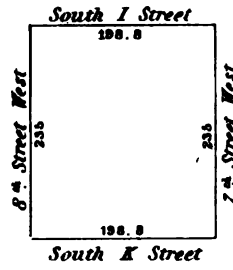



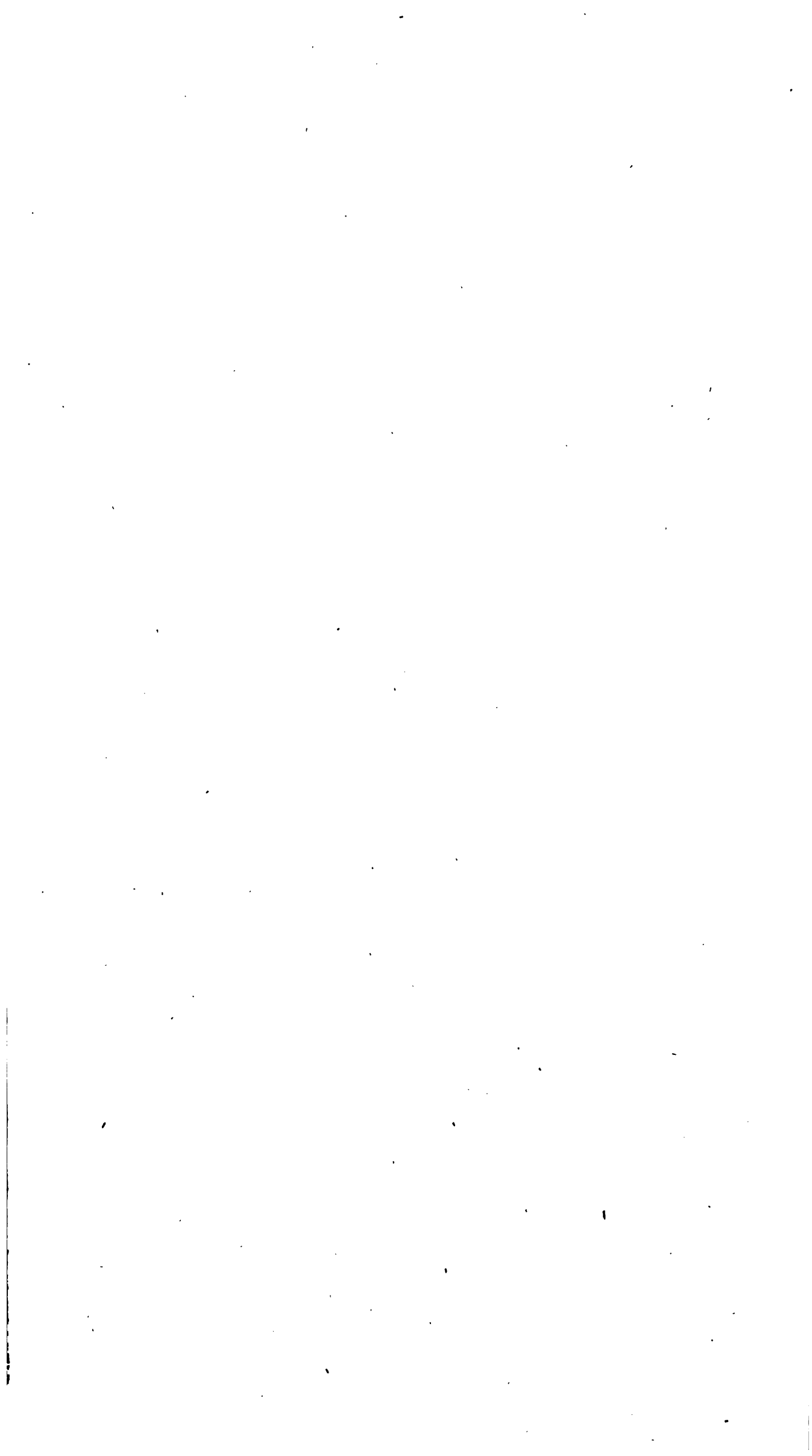

SQUARE N°444

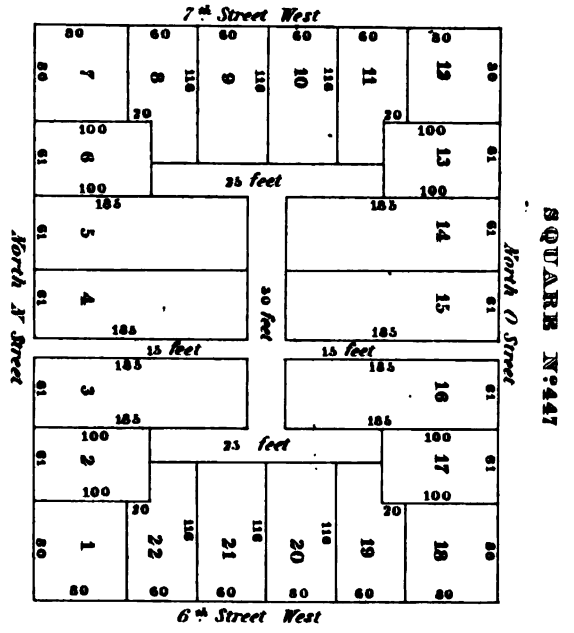
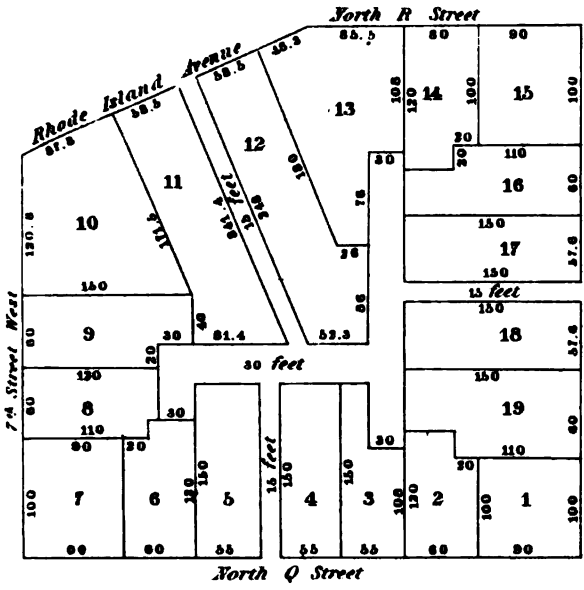

SQUARE N°445

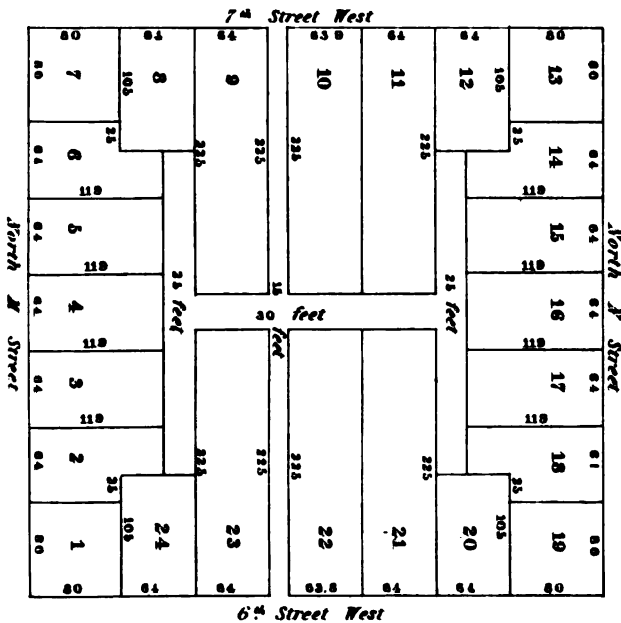
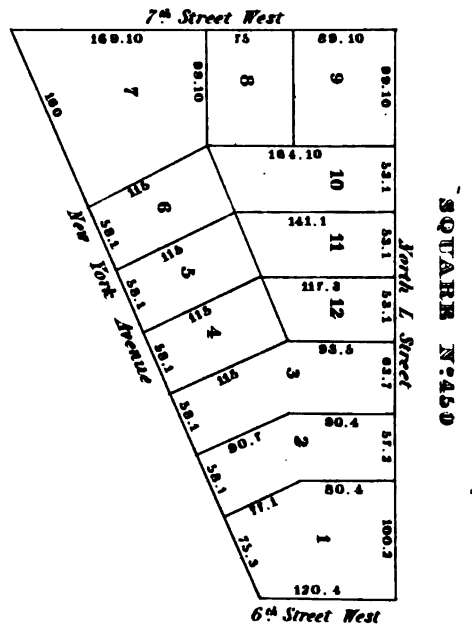
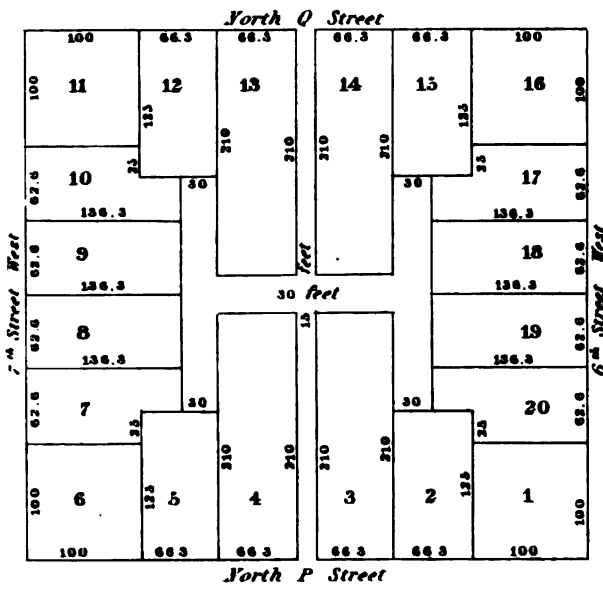

SQUARE N°448

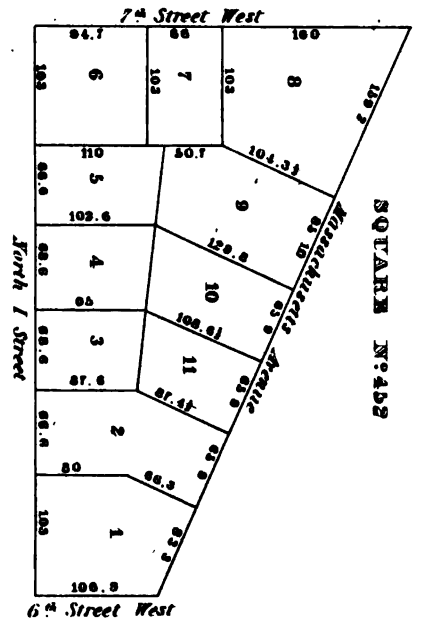

SQUARE N°451

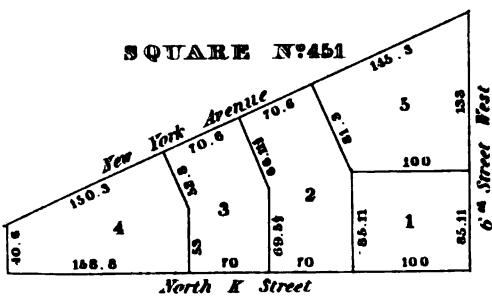

SQUARE N°450

SQUARE N°452



SQUARE N:449

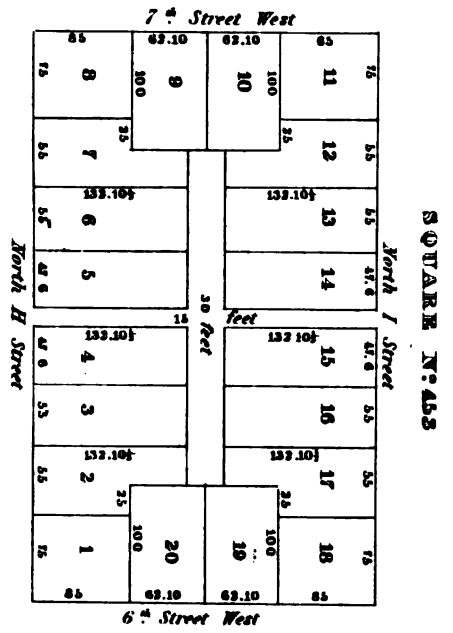
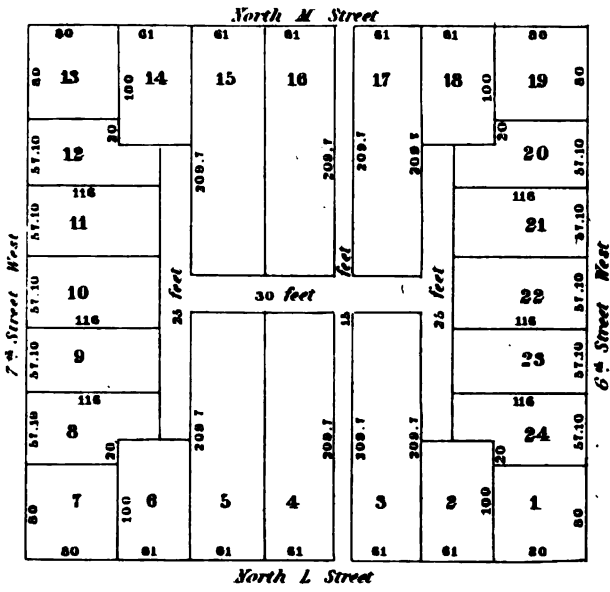

SQUARE N:454

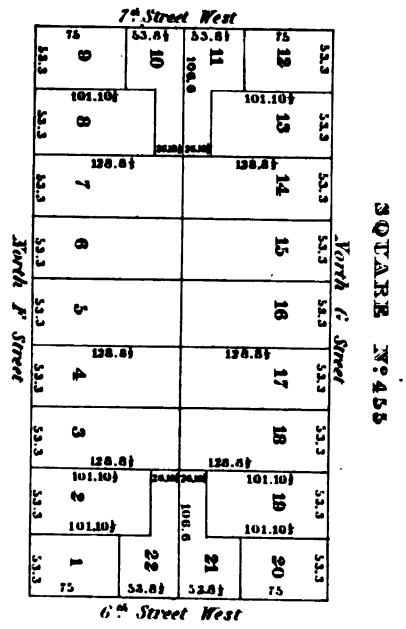
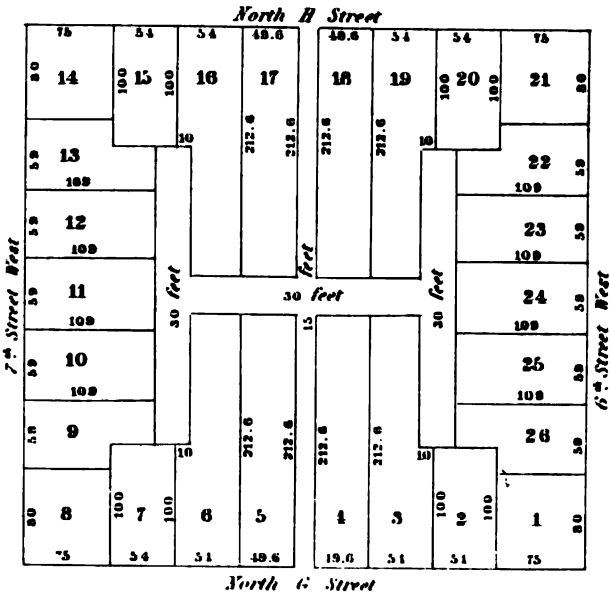

SQUARE N:457

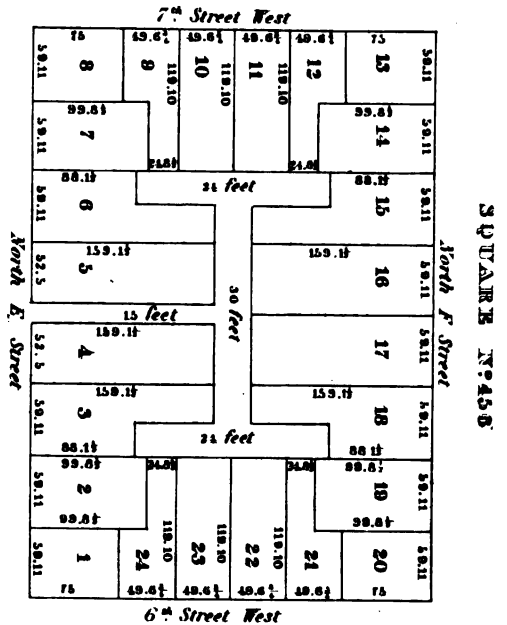
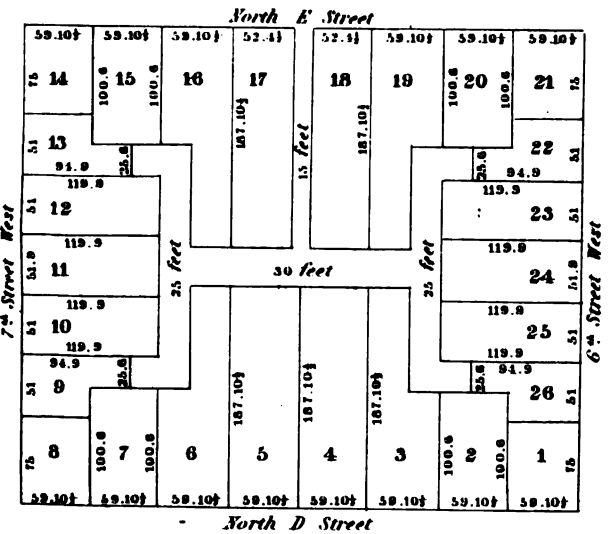



**SQUARE N:458**

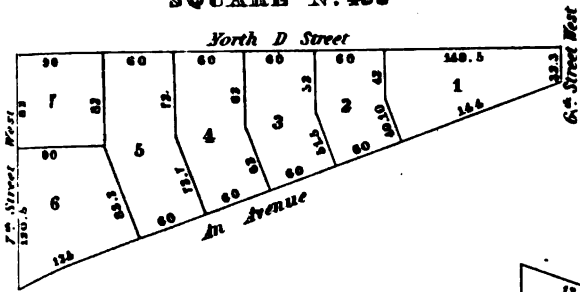

**SQUARE N:459**

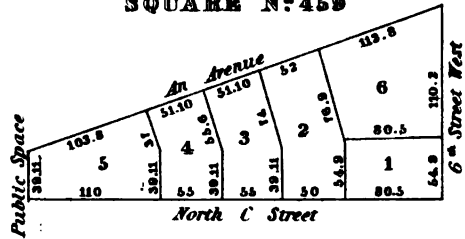

**SQUARE N:460**

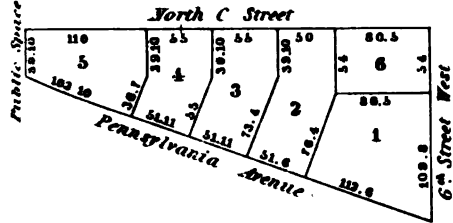

**SQUARE N:461**

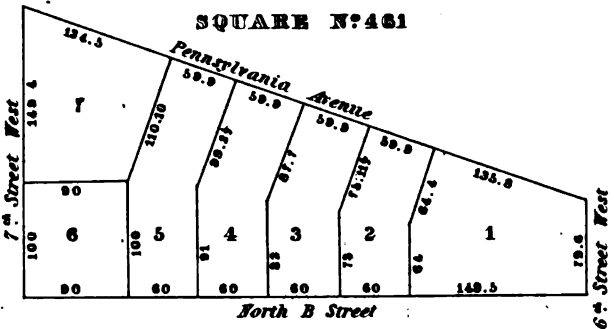

**SQUARE N:482**

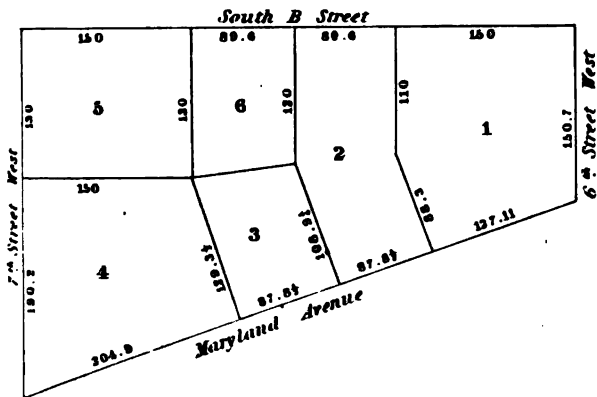

**Public Space**

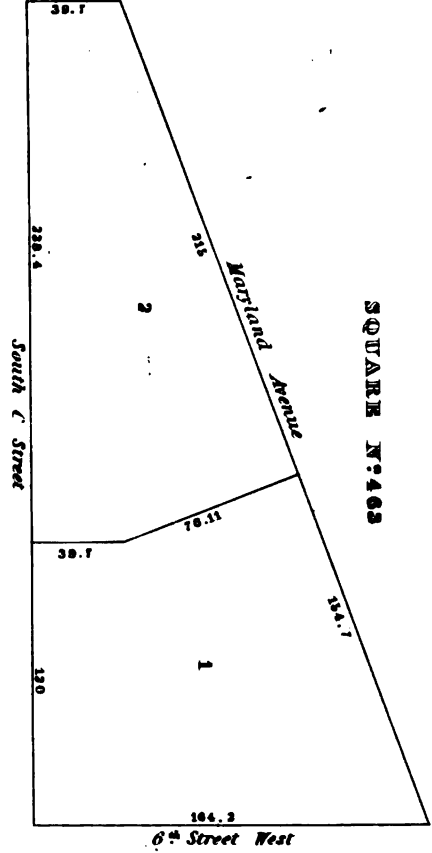

**SQUARE N:483**

**Public Space**

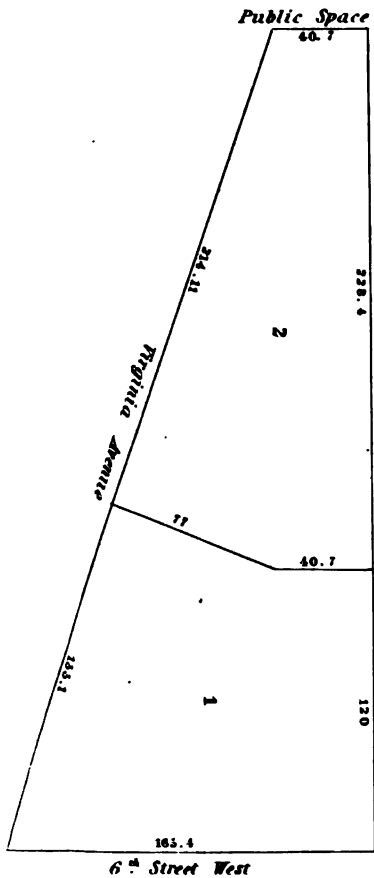

**SQUARE S.O.P N:485**

**SQUARE N:486**

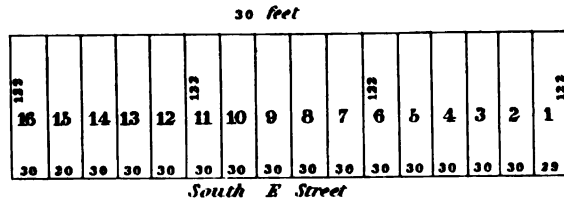
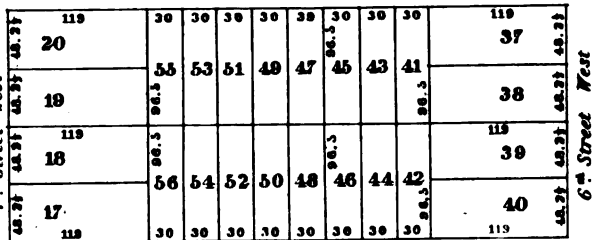
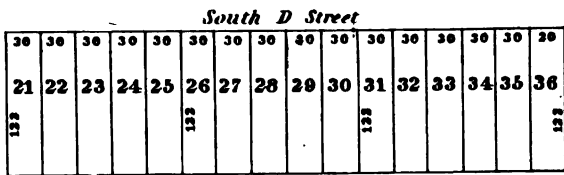

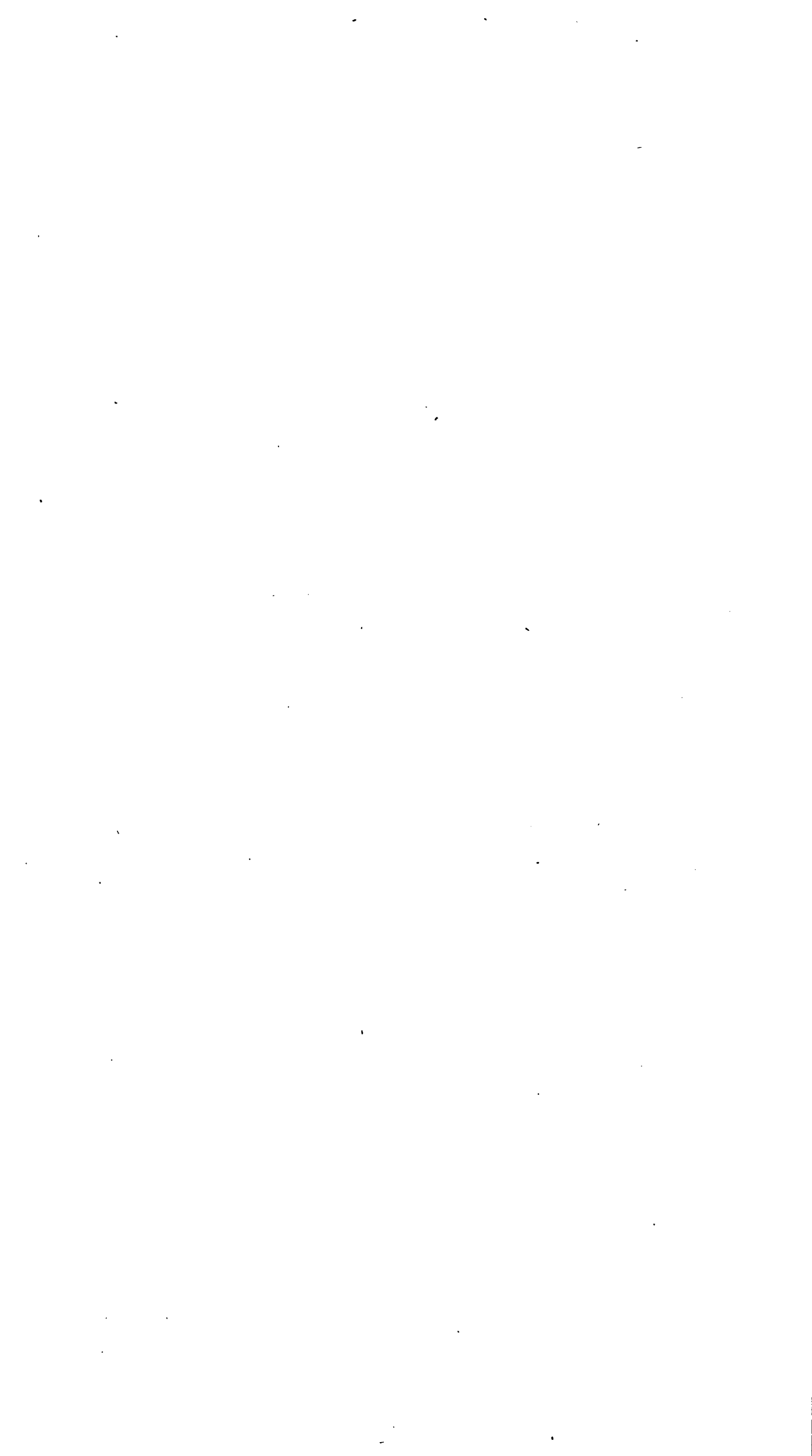

**SQUARE N°466**

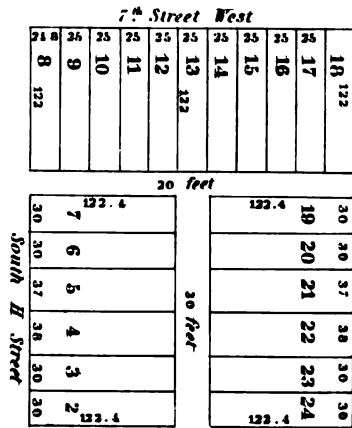
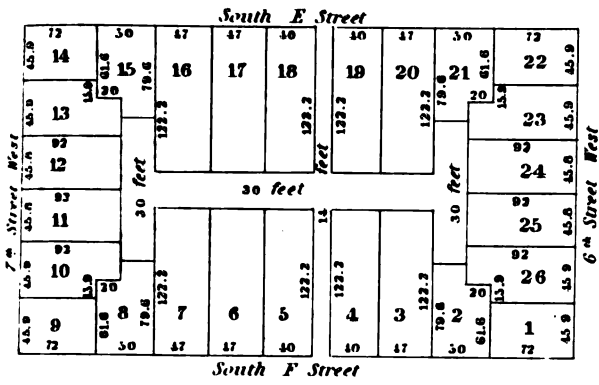

**SQUARE N°466**

**SQUARE N°467**

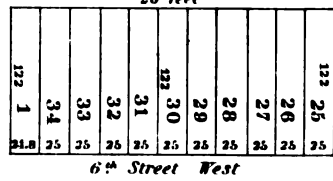
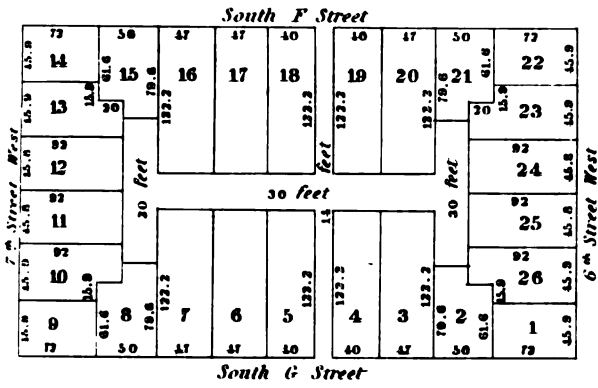

**SQUARE N°469**

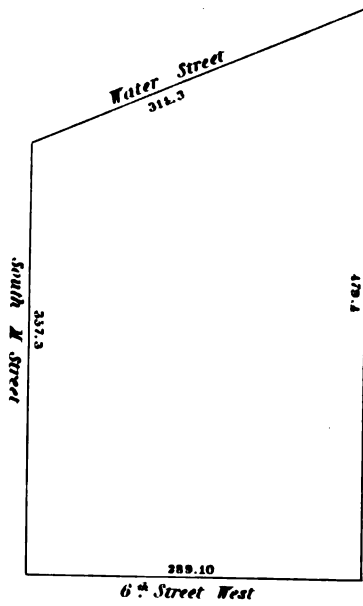
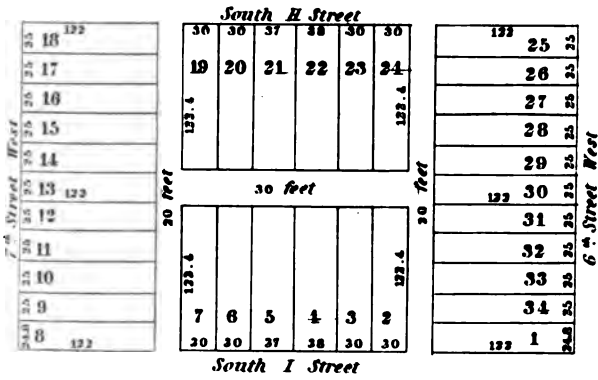

**SQUARE N°472**

**SQUARE N°470**

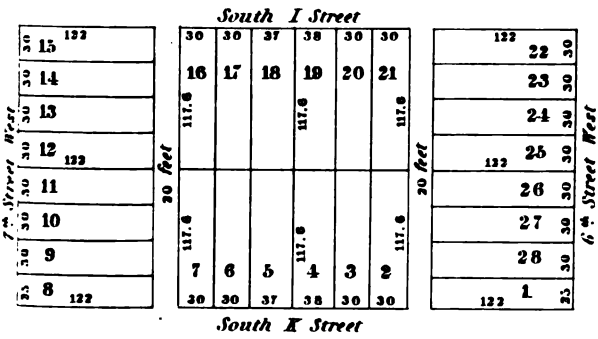

**SQUARE W. OF N°471**

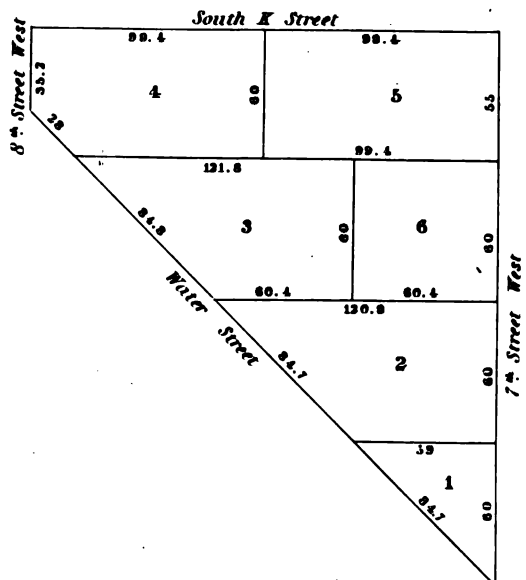

**SQUARE N°471**

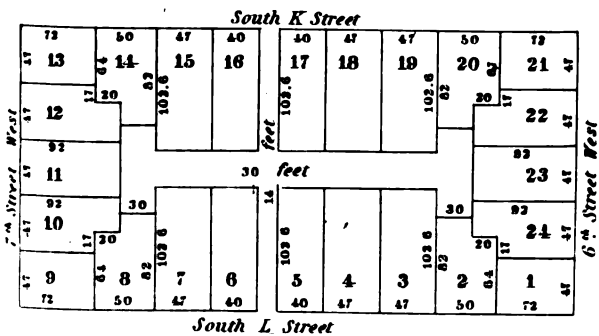





**SQUARE N:473**

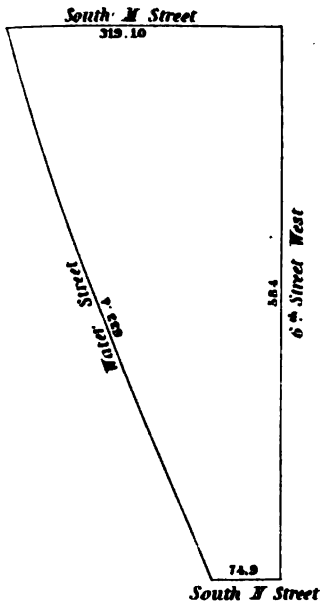

**SQUARE N:475**

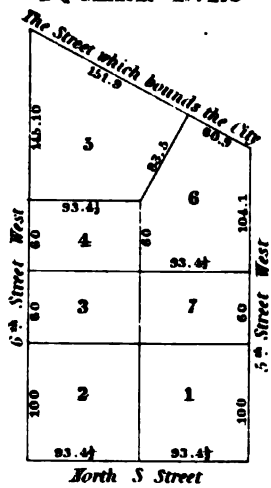

**SQUARE E. OF N:476**

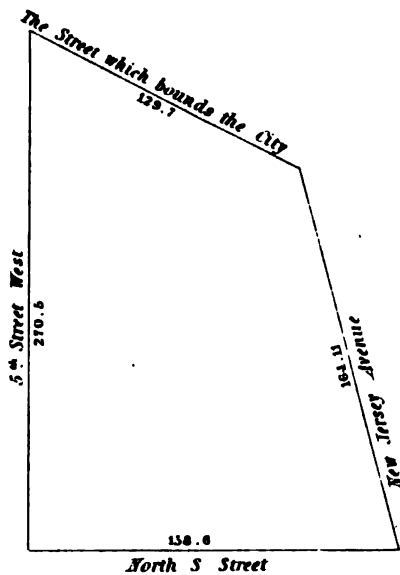

**SQUARE S. OF N:475**

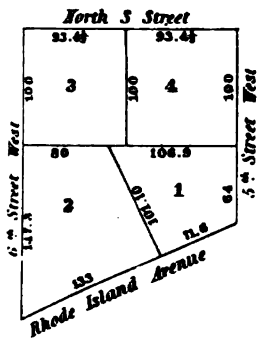

**SQUARE N:476**

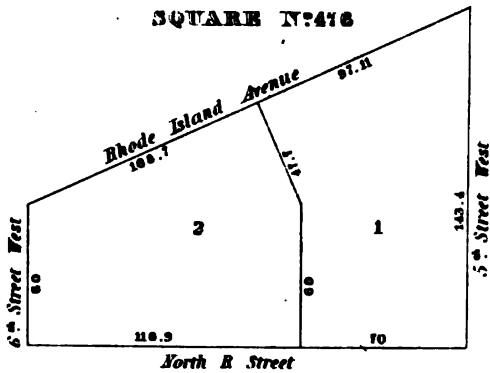

**SQUARE N:477**

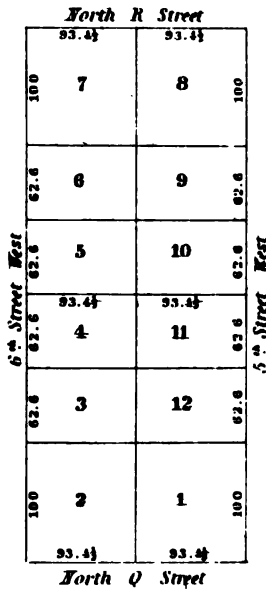

**SQUARE N:479**

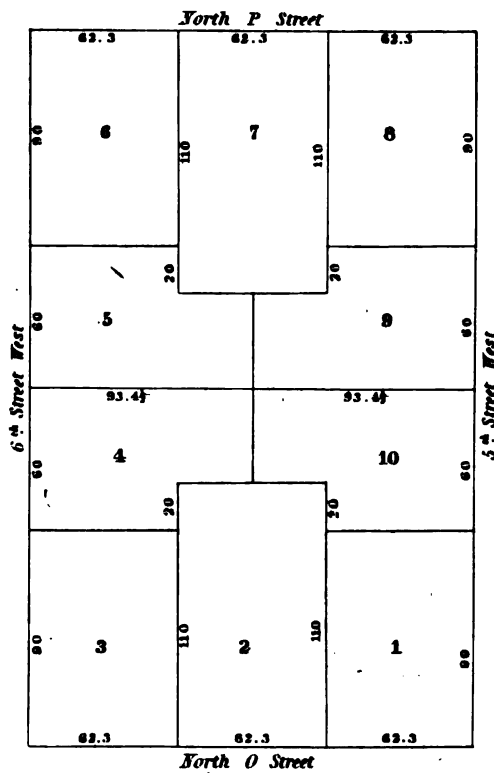

**SQUARE N:478**

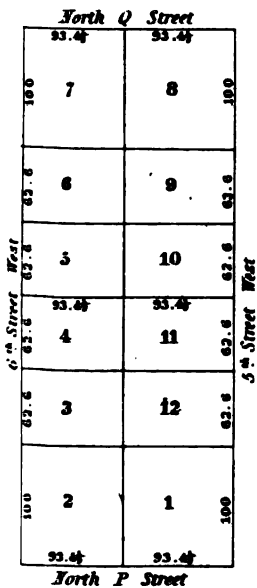

**SQUARE N:480**

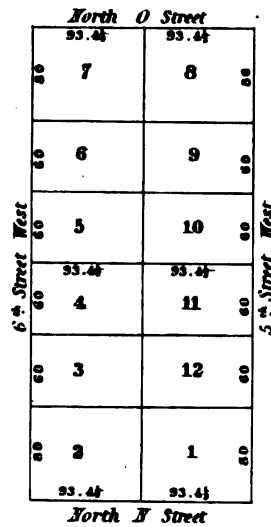



**SQUARE N:481**

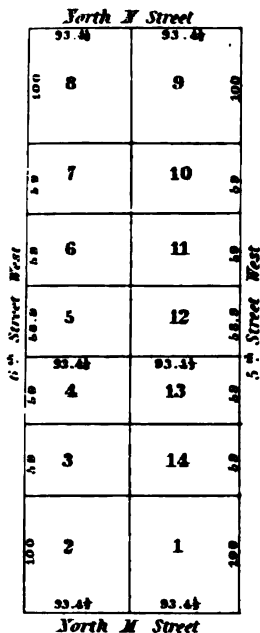

**SQUARE N:482**

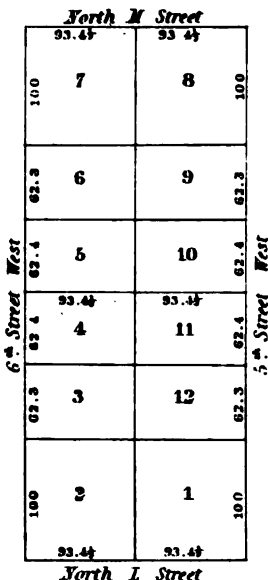

**SQUARE S. OF N:482**

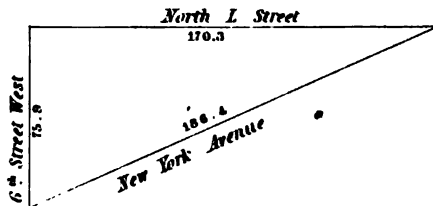

**SQUARE N:483**

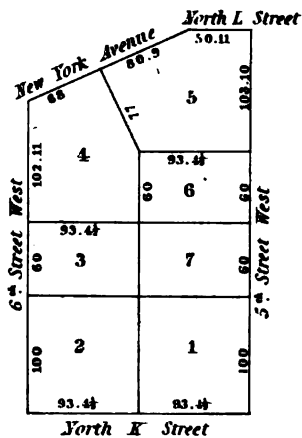

**SQUARE N:484**

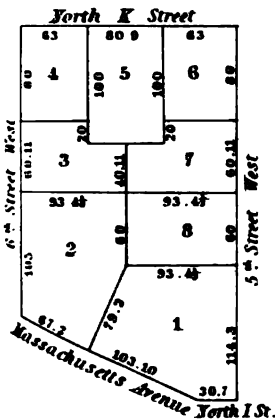

**SQUARE W. OF N:484**

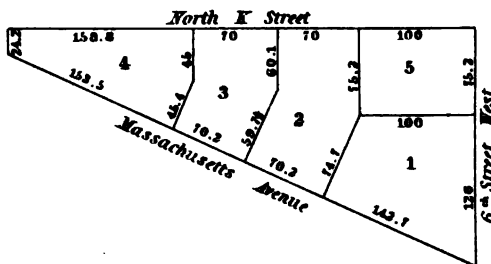

**SQUARE N:485**

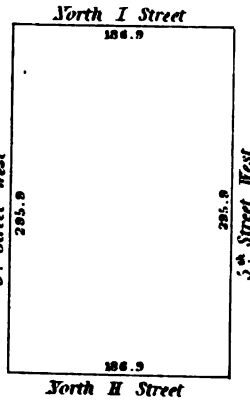

**SQUARE N:486**

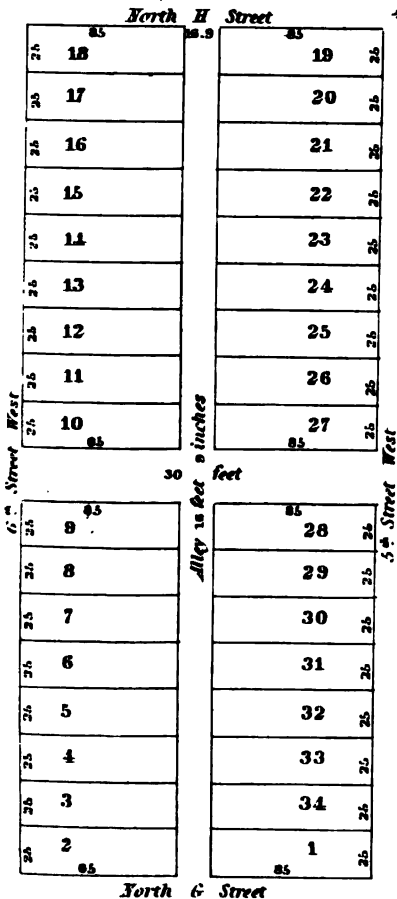

**SQUARE N:487**

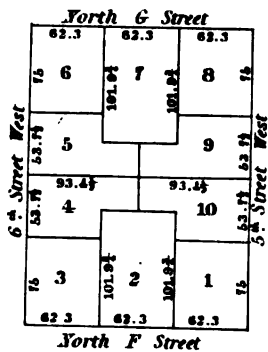

**SQUARE N:488**

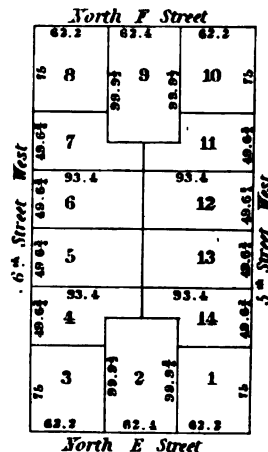

**SQUARE N:489**

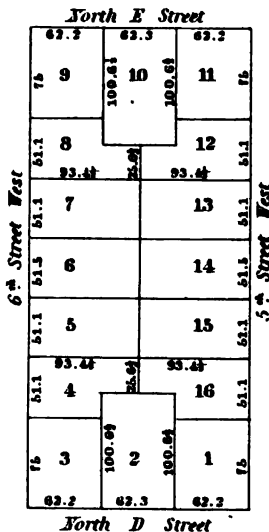



SQUARE N:490

North D Street

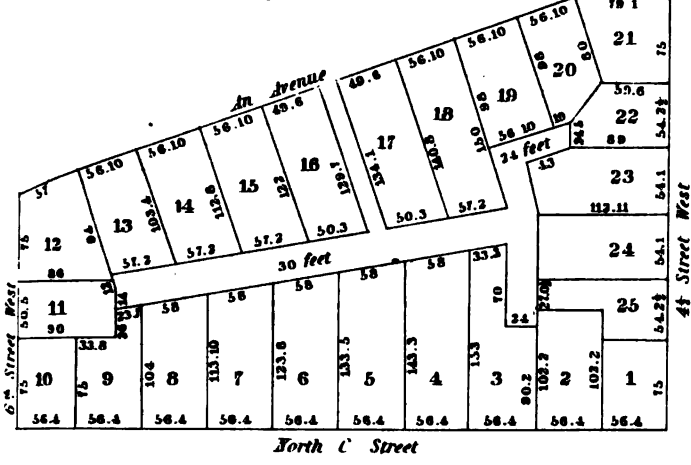

6th Street West

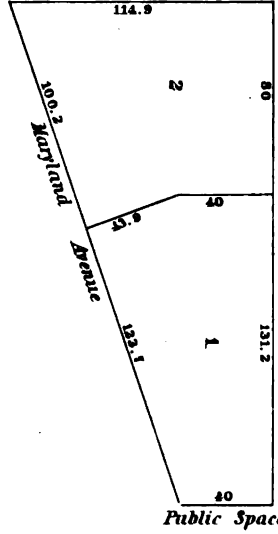

SQUARE NW of N:492

SQUARE N:491

North C Street

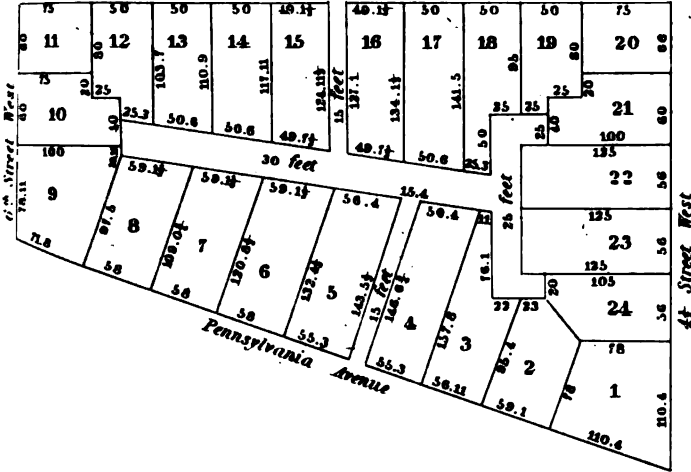

6th Street West

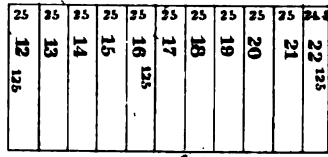

SQUARE N:493

SQUARE N:492

Maryland Avenue

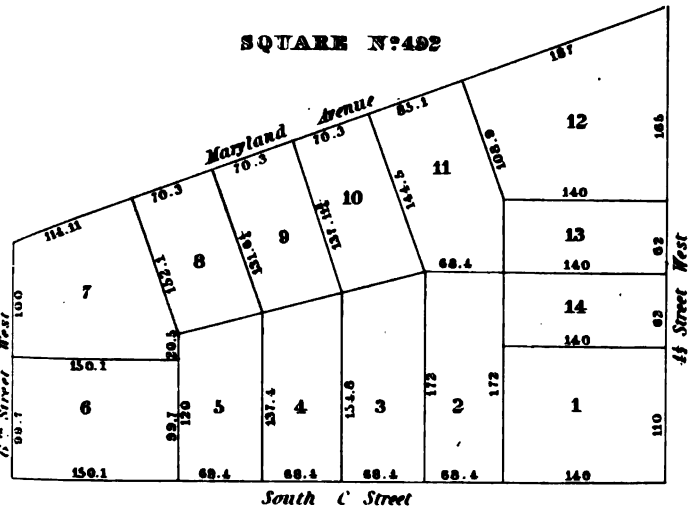

6th Street West

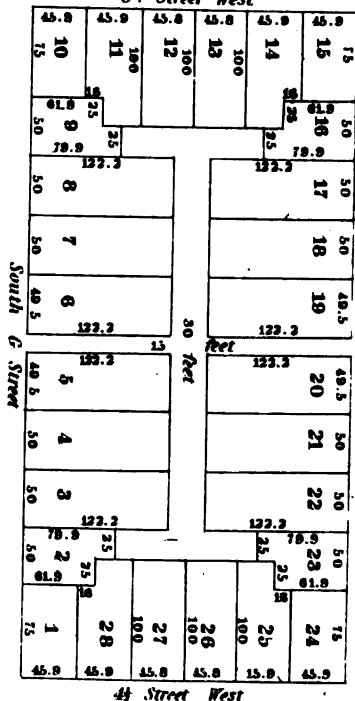

SQUARE N:490

SQUARE N:493

South C Street

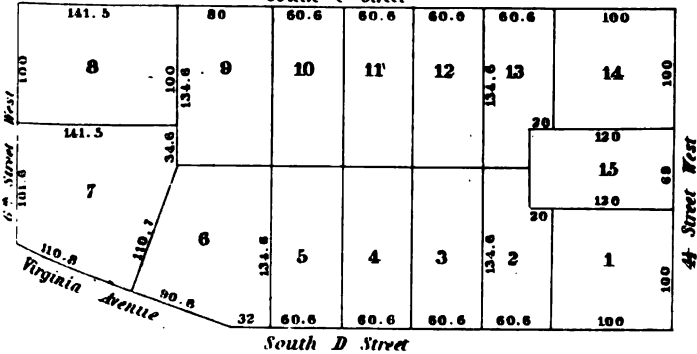



**SQUARE N:494**

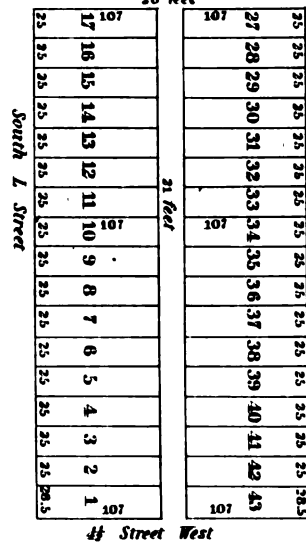
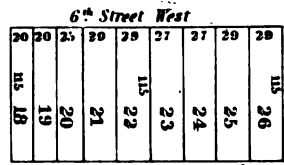
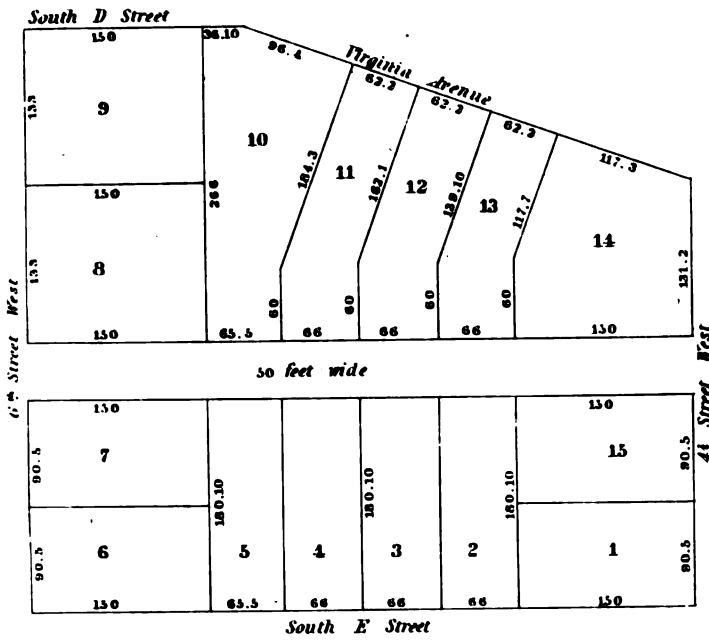

**SQUARE N:500**

**SQUARE N:497**

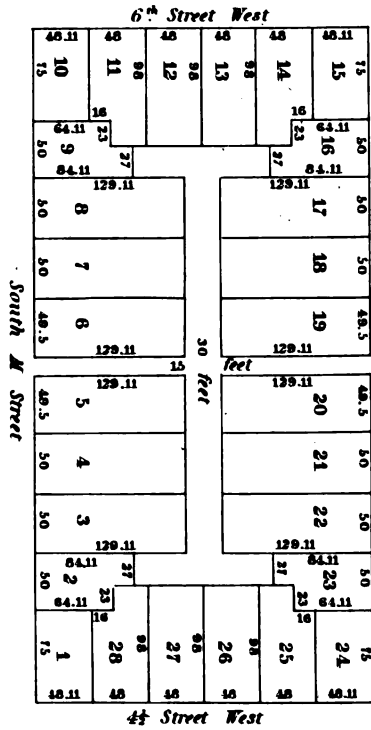
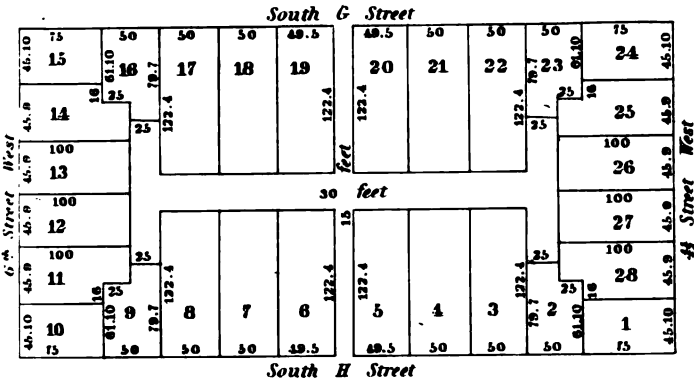

**SQUARE N:501**

**SQUARE N:498**

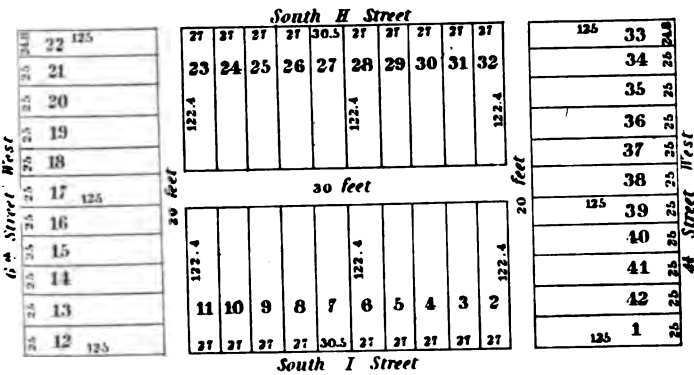

**SQUARE N:503**

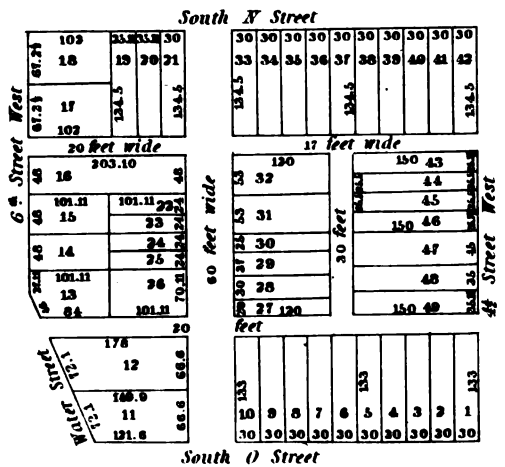

**SQUARE N:499**

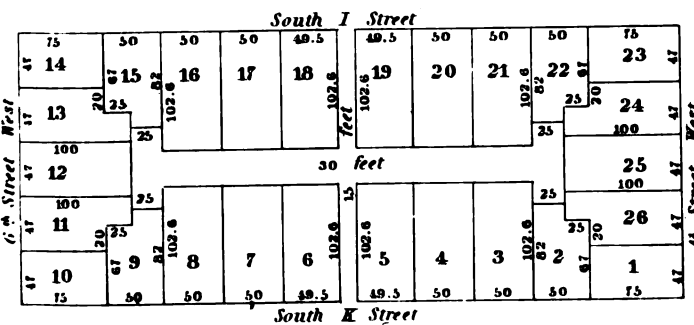





**SQUARE N:502**

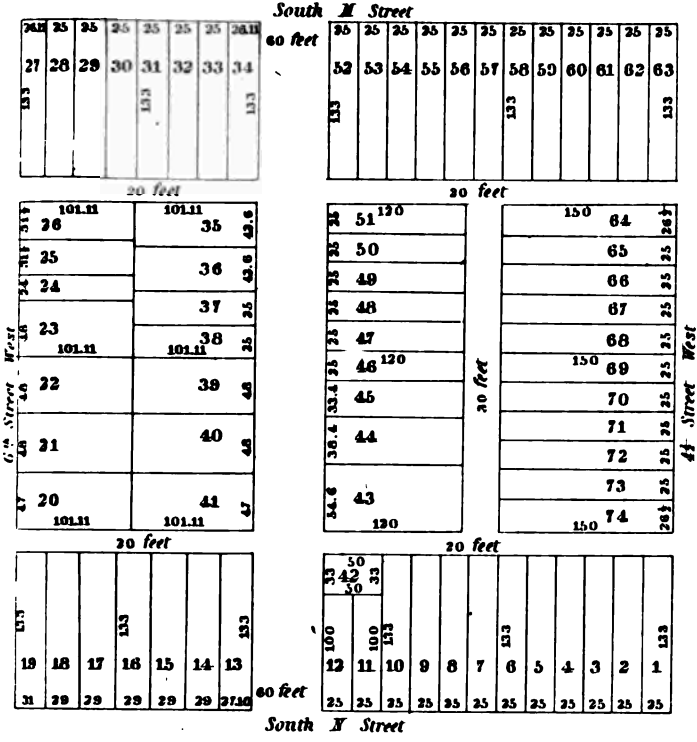

**SQUARE N:505**

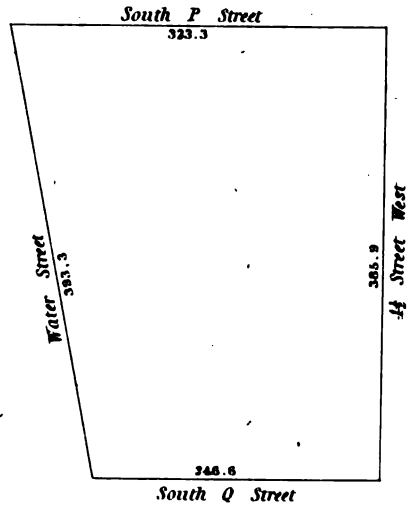

**SQUARE N:508**

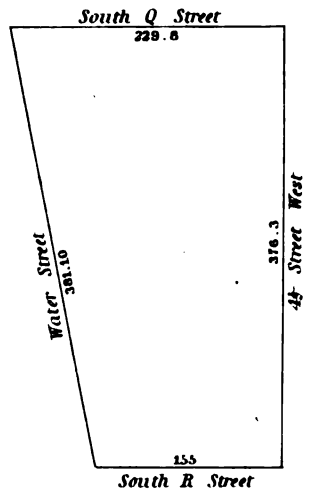

**SQUARE N:507**

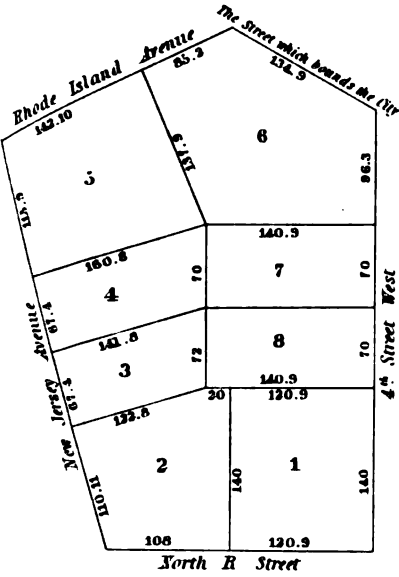

**SQUARE N. OF N:507**

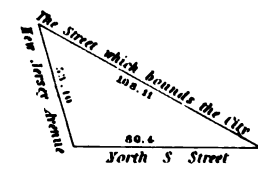

**SQUARE N:508**

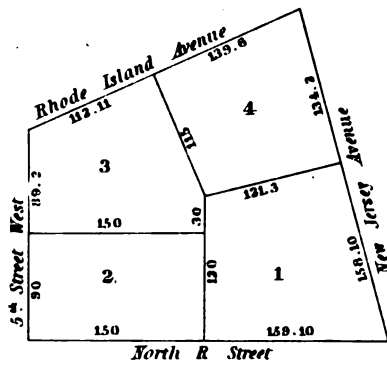

**SQUARE S. OF N:508**

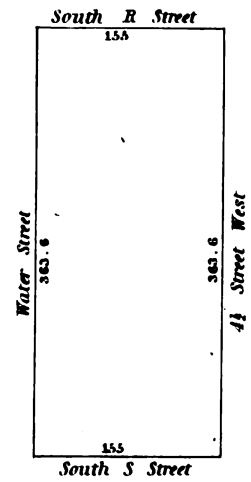

**SQUARE N:509**

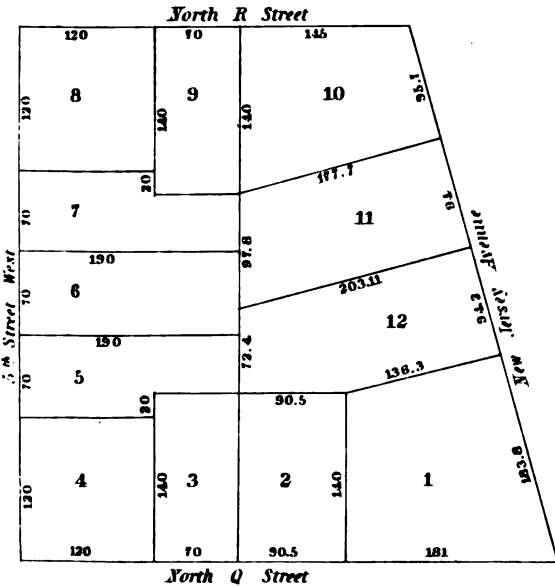

**SQUARE N. OF N:508**

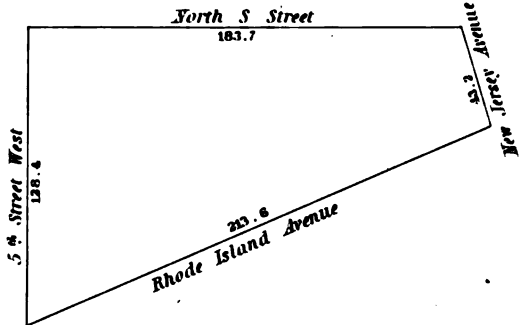

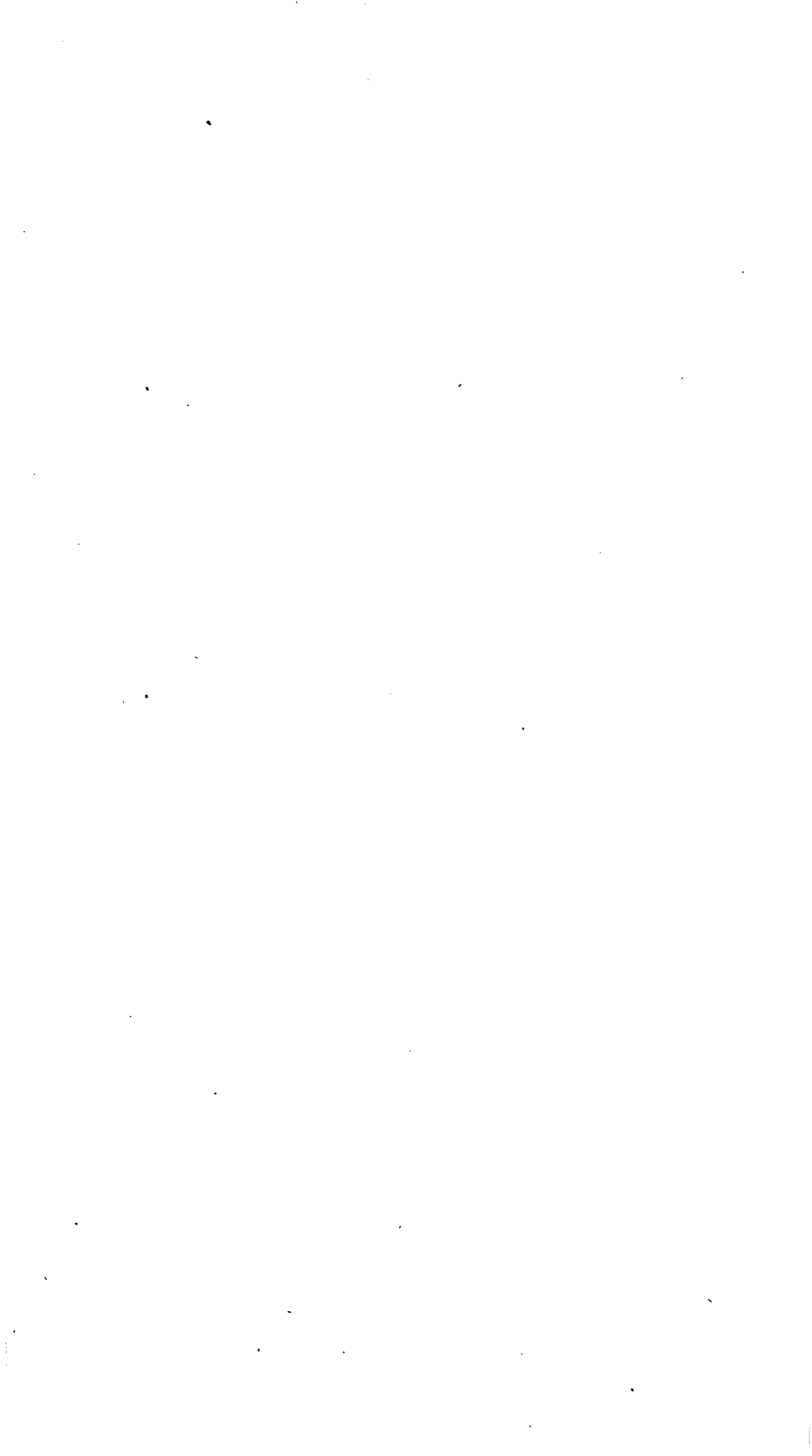

**SQUARE N°511**

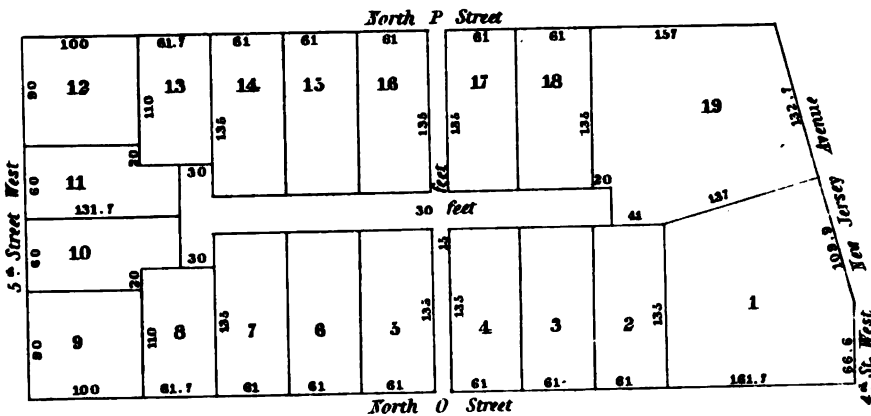

**SQUARE N°512**

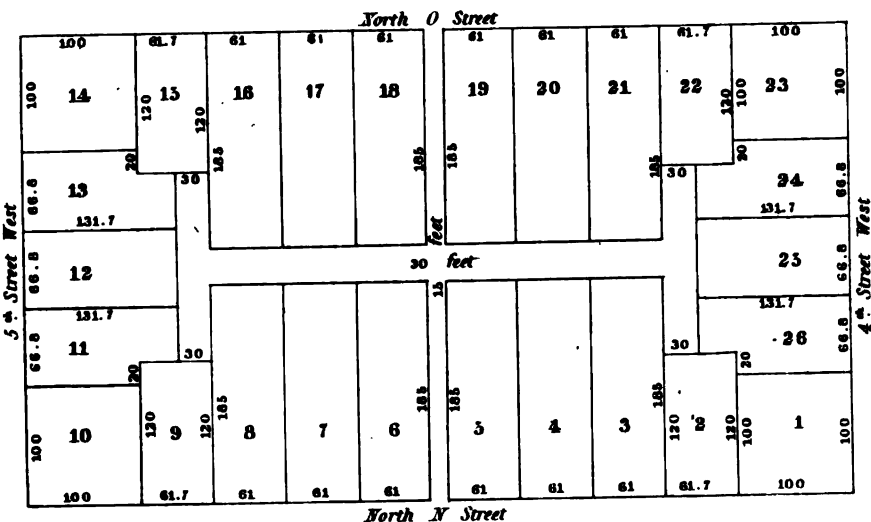

**SQUARE N°513**

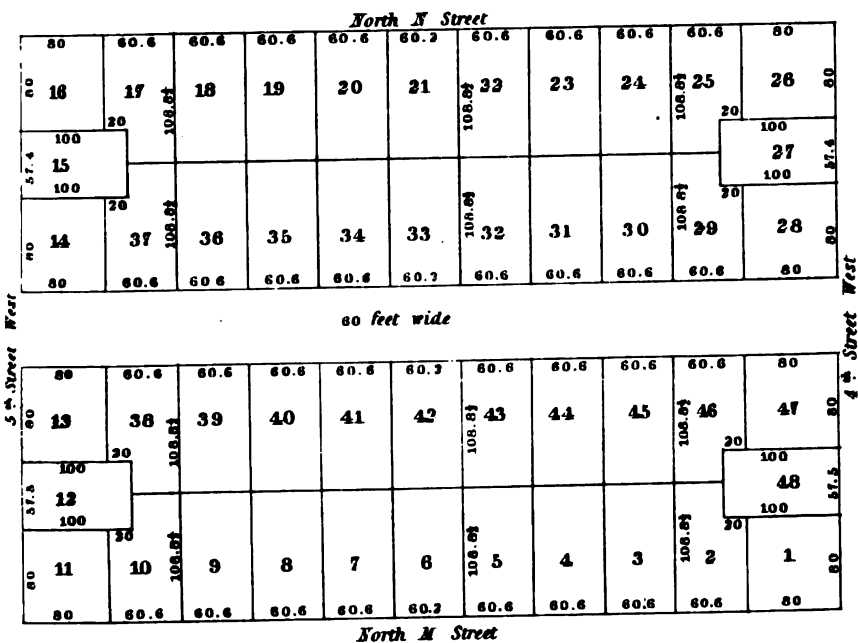

**SQUARE E. OF N°509**

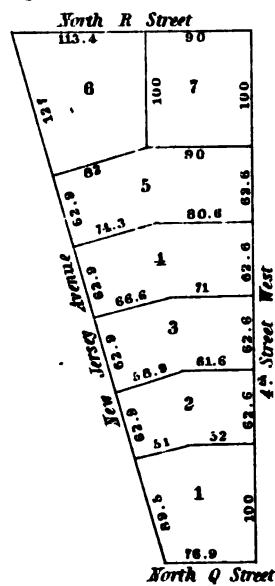

**SQUARE E. OF N°510**

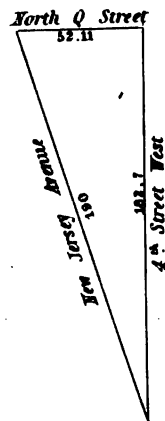

**SQUARE N. OF N°515**

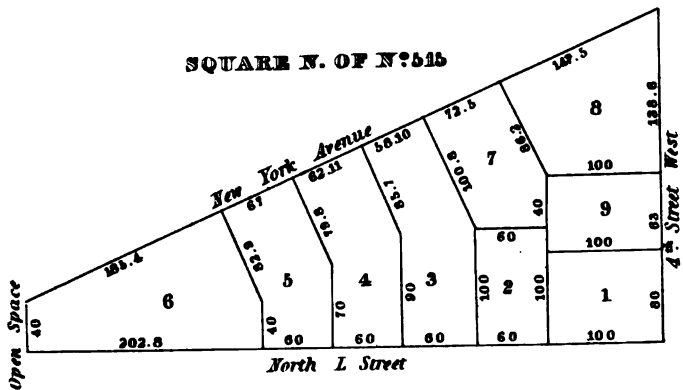

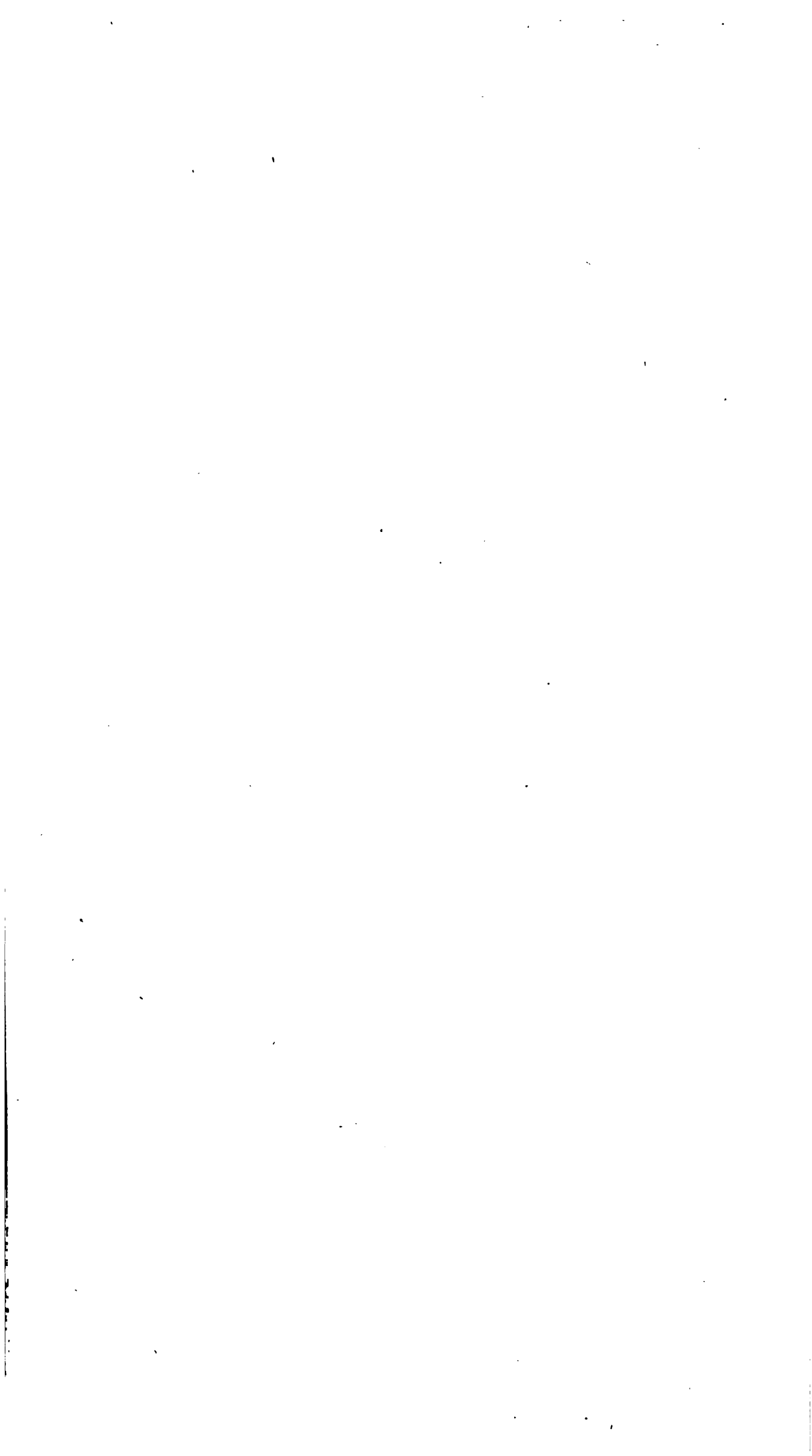

SQUARE N°514

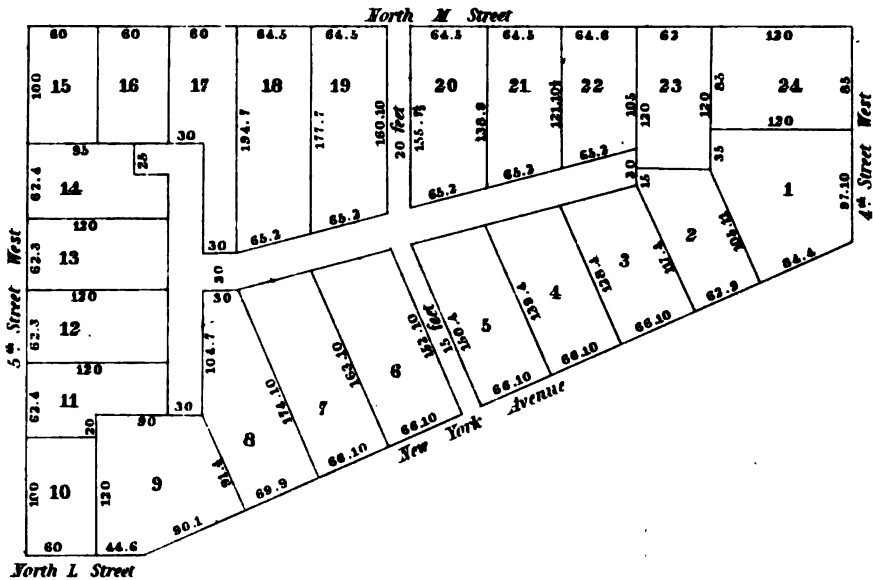

SQUARE N°515

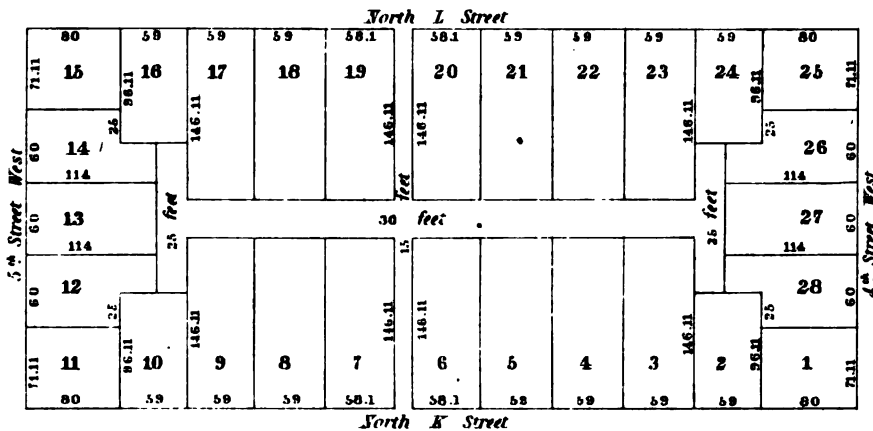

SQUARE N°518

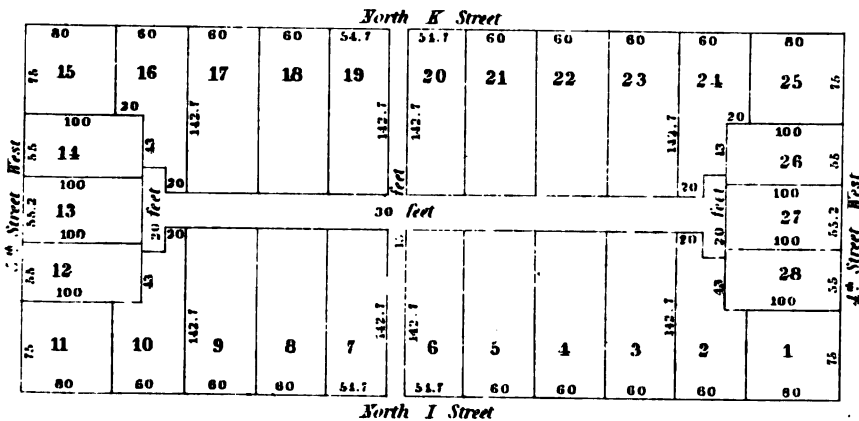

SQUARE E. OF N°518

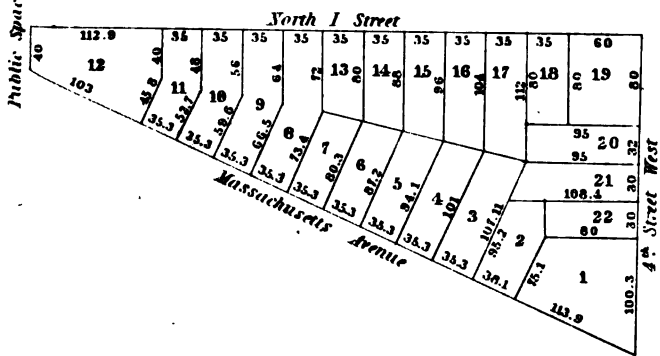

SQUARE N°517

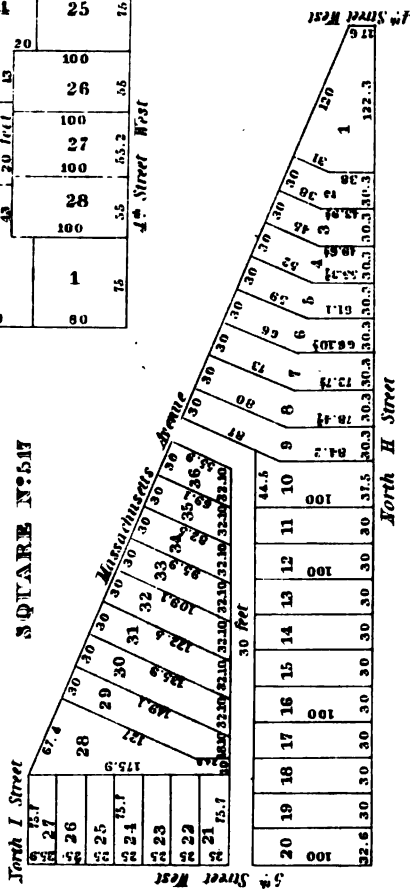



**SQUARE N:518**

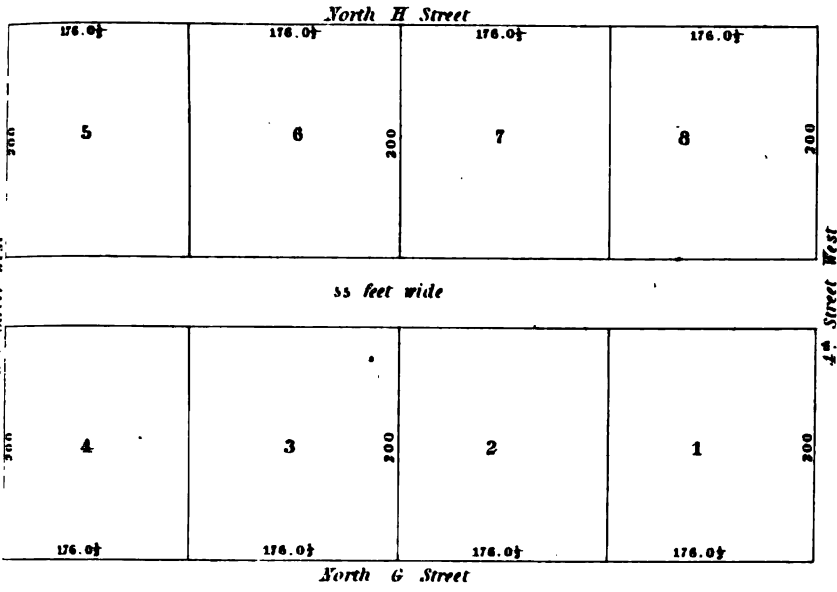

**SQUARE N:519**

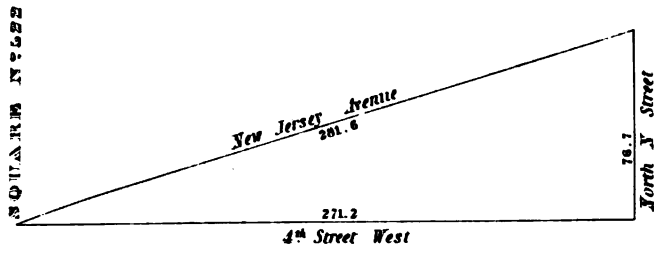
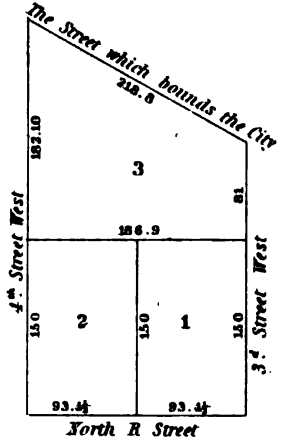

**SQUARE N:520**

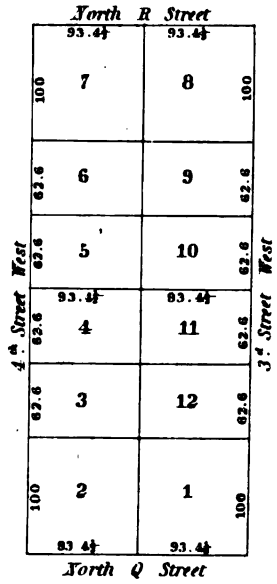

**SQUARE N:524**

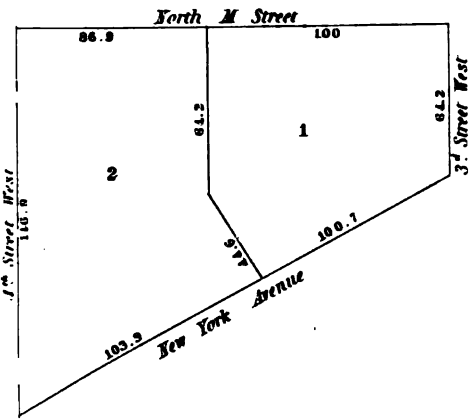

**SQUARE N:528**

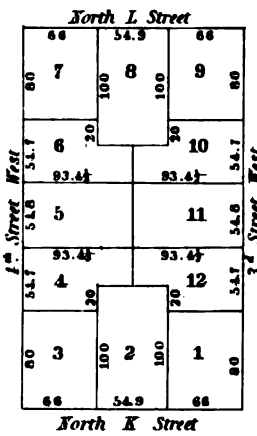

**SQUARE N:523**

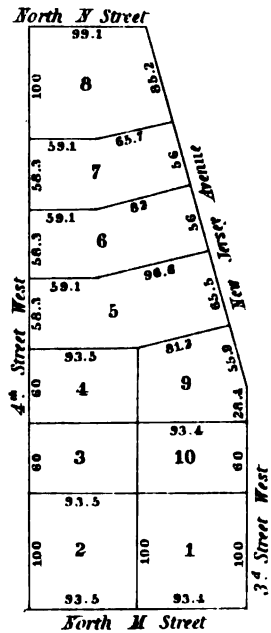

**SQUARE N:525**

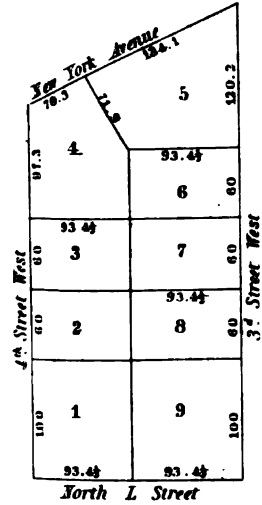

**SQUARE N:527**

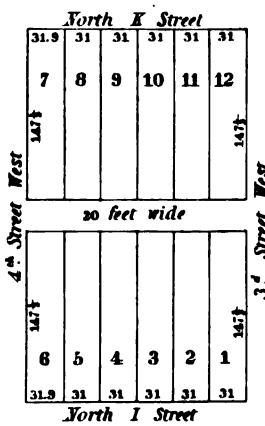



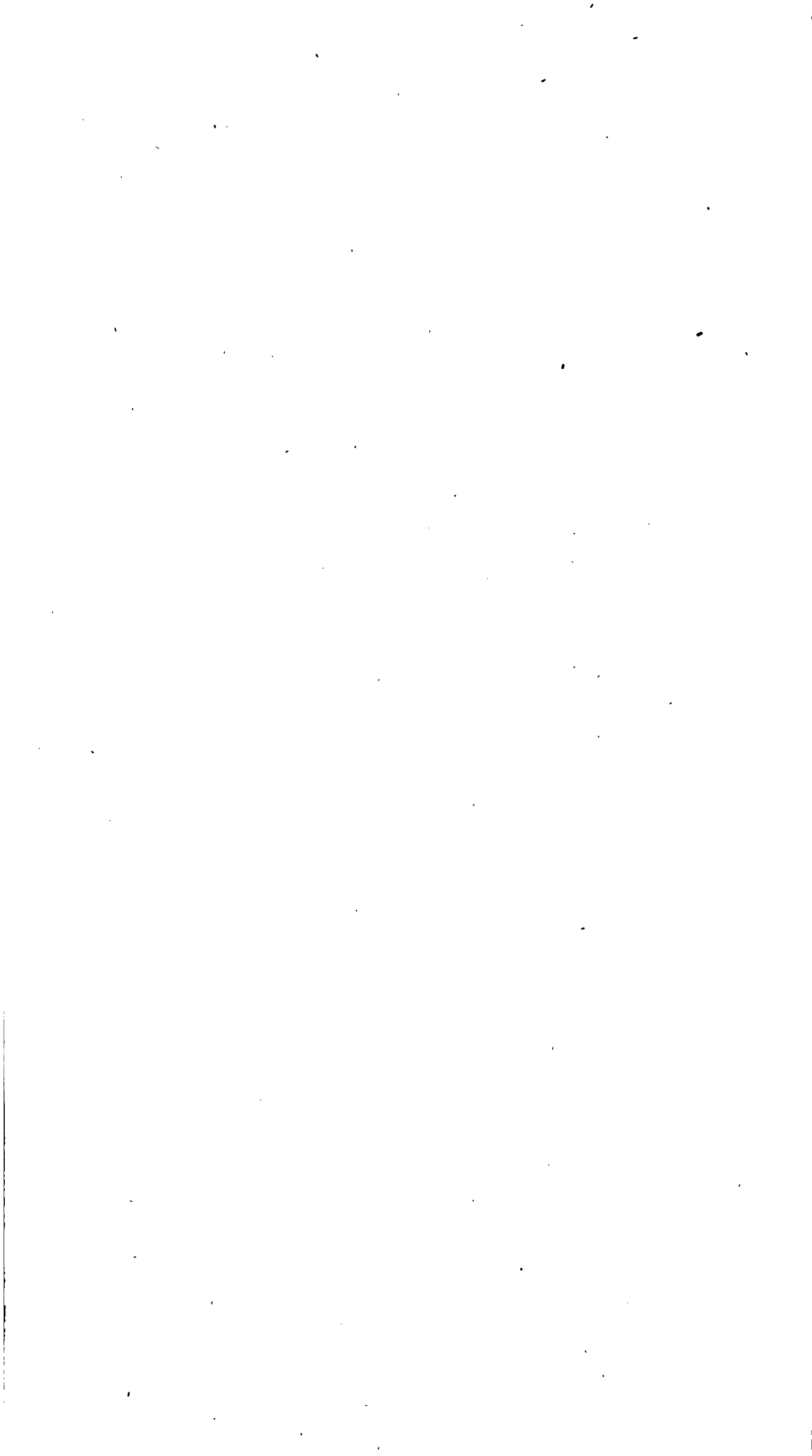

SQUARE N:528

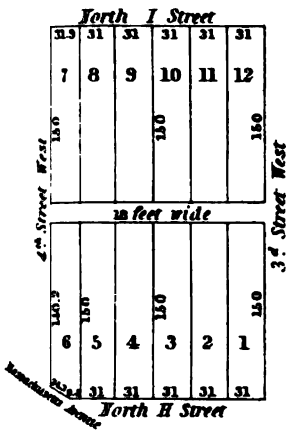

SQUARE N:529

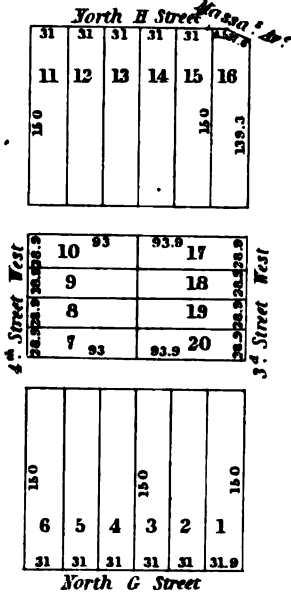

SQUARE N:530

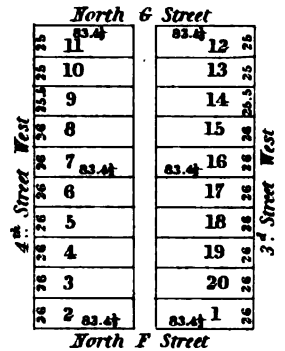

SQUARE N:531

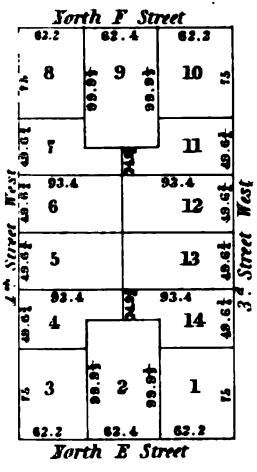

SQUARE N:532

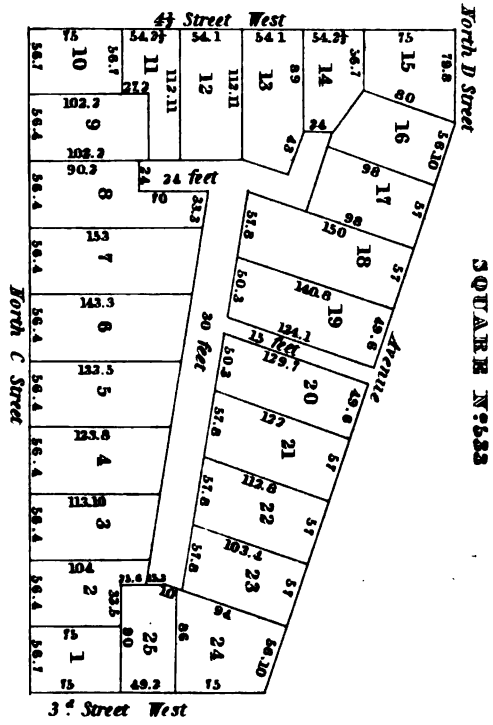
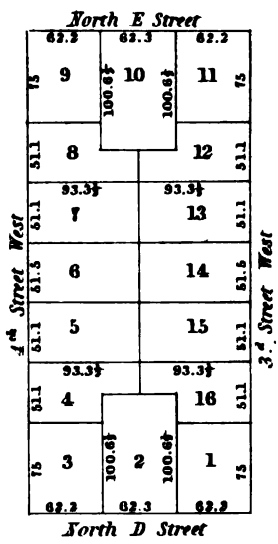

SQUARE N:534

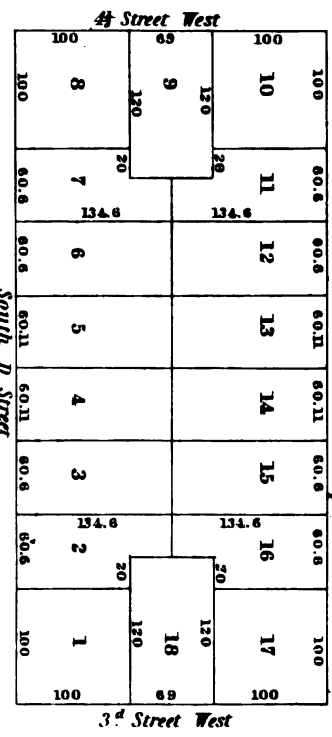
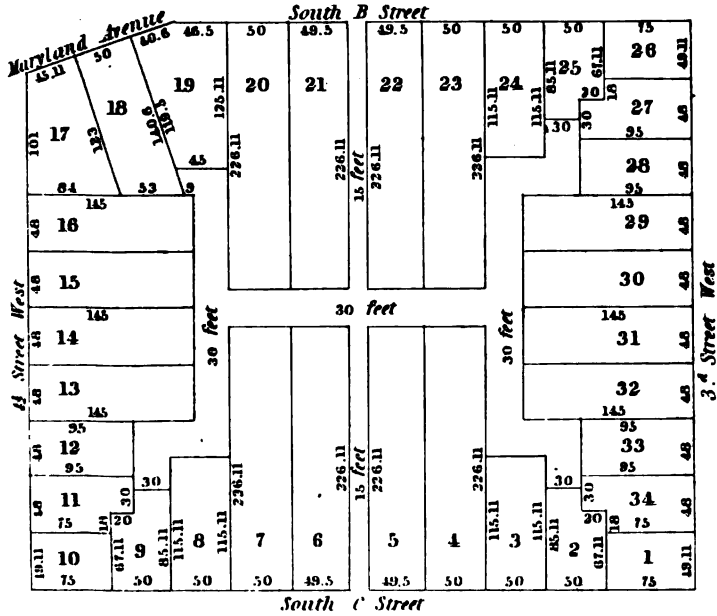



SQUARE N:538

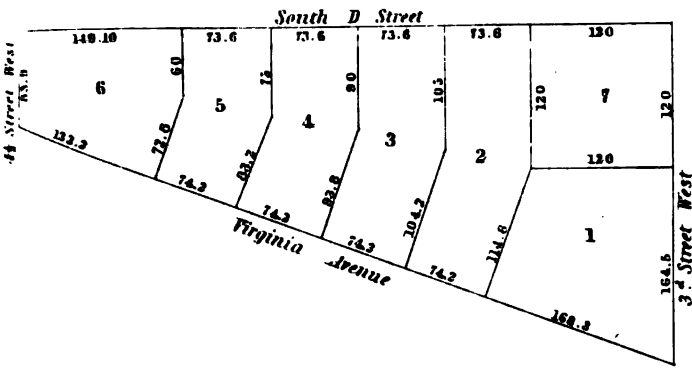

SQUARE N:537

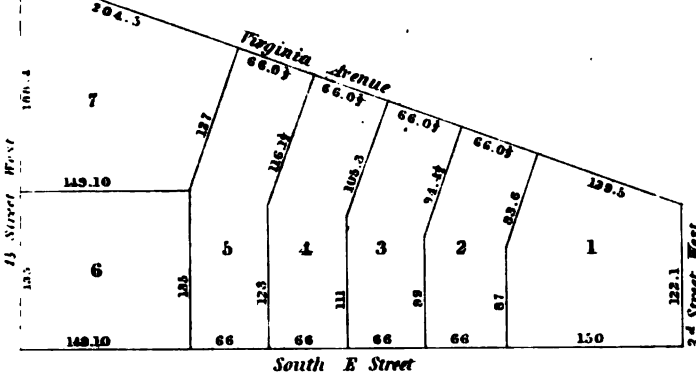

SQUARE N:536

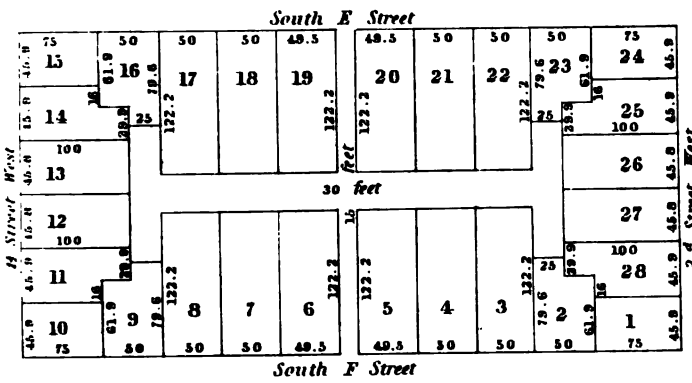

SQUARE N:539

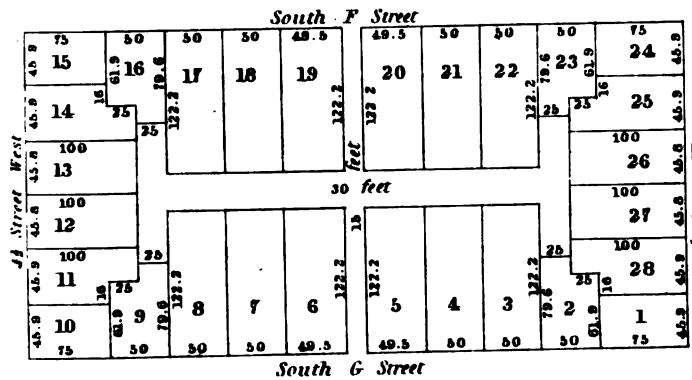

SQUARE N:640

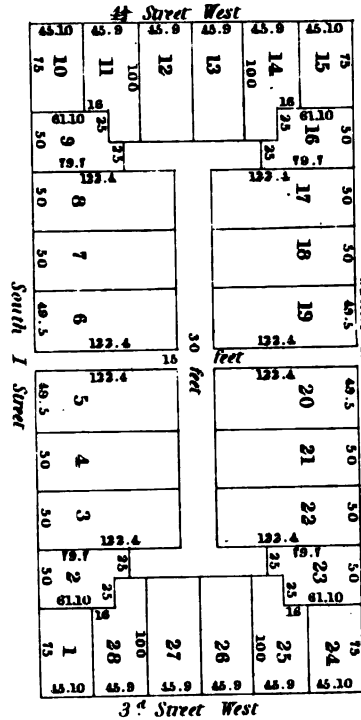
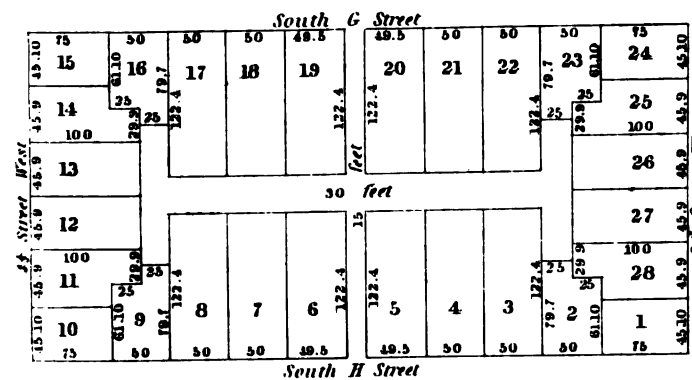

SQUARE N:641

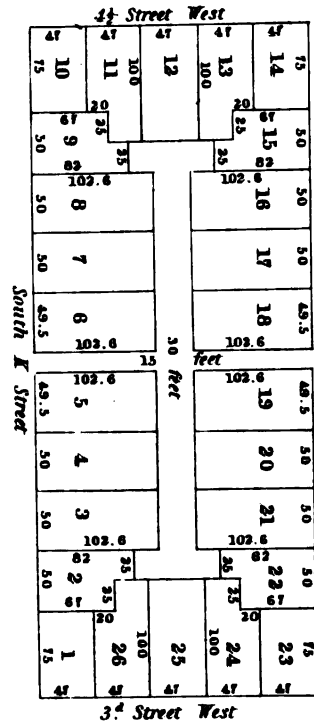

SQUARE N:642

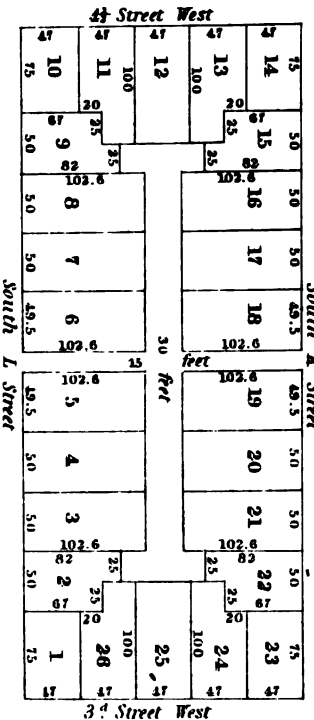

SQUARE N:643



SQUARE N:544

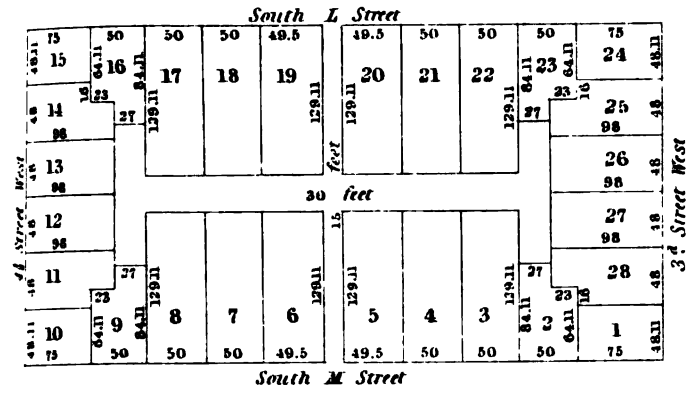

SQUARE E. OF N:544

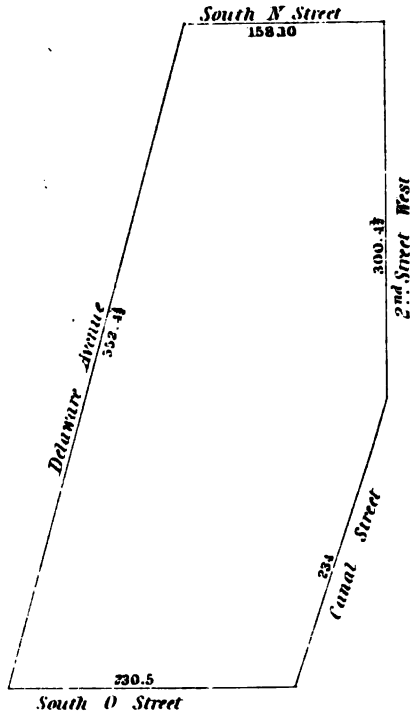

SQUARE N:545

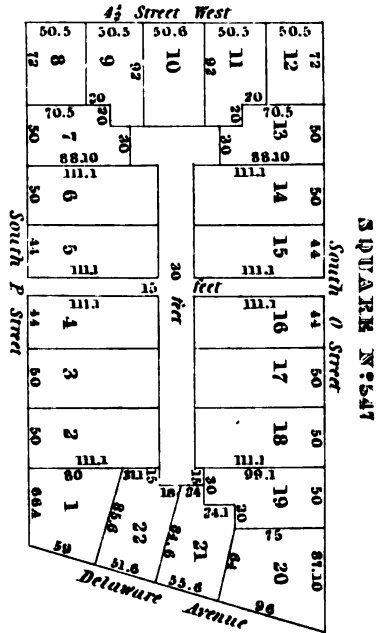
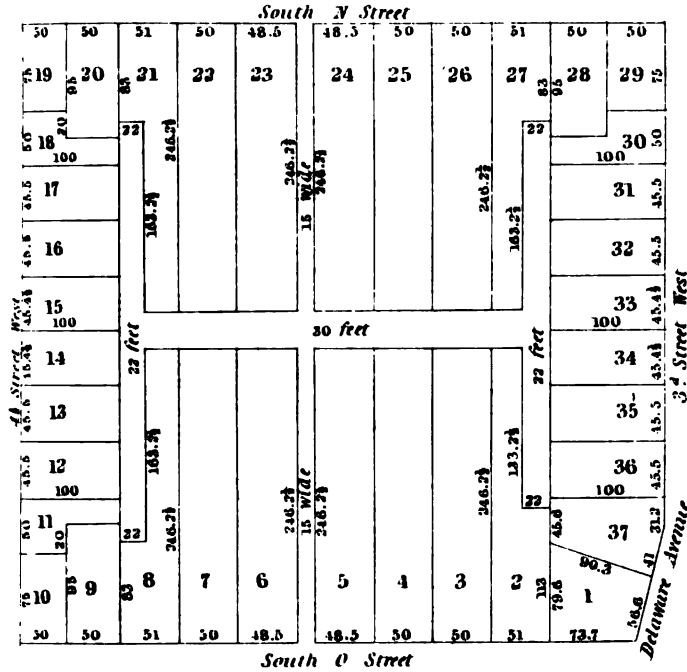

SQUARE N:546

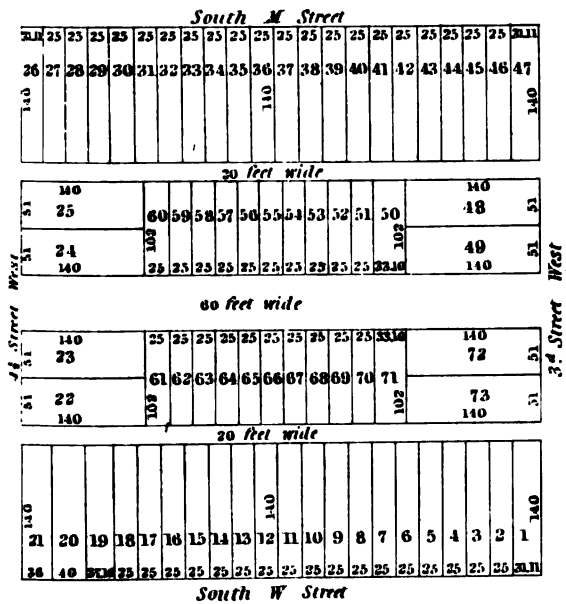

SQUARE N:548

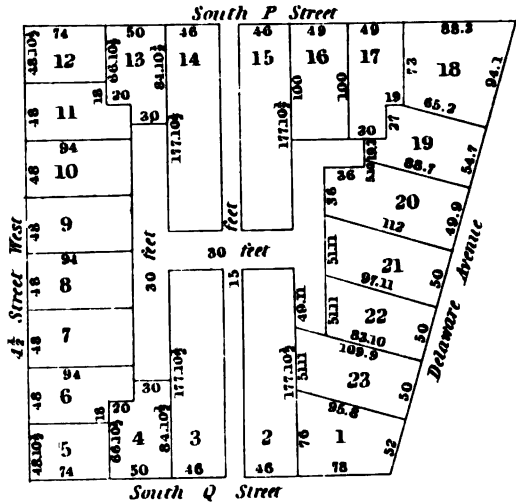

SQUARE E. OF N:547

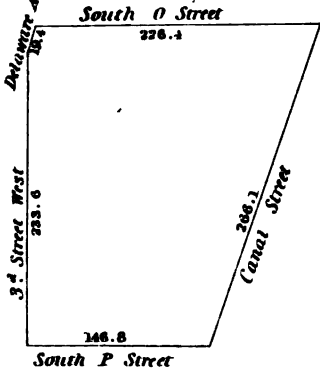

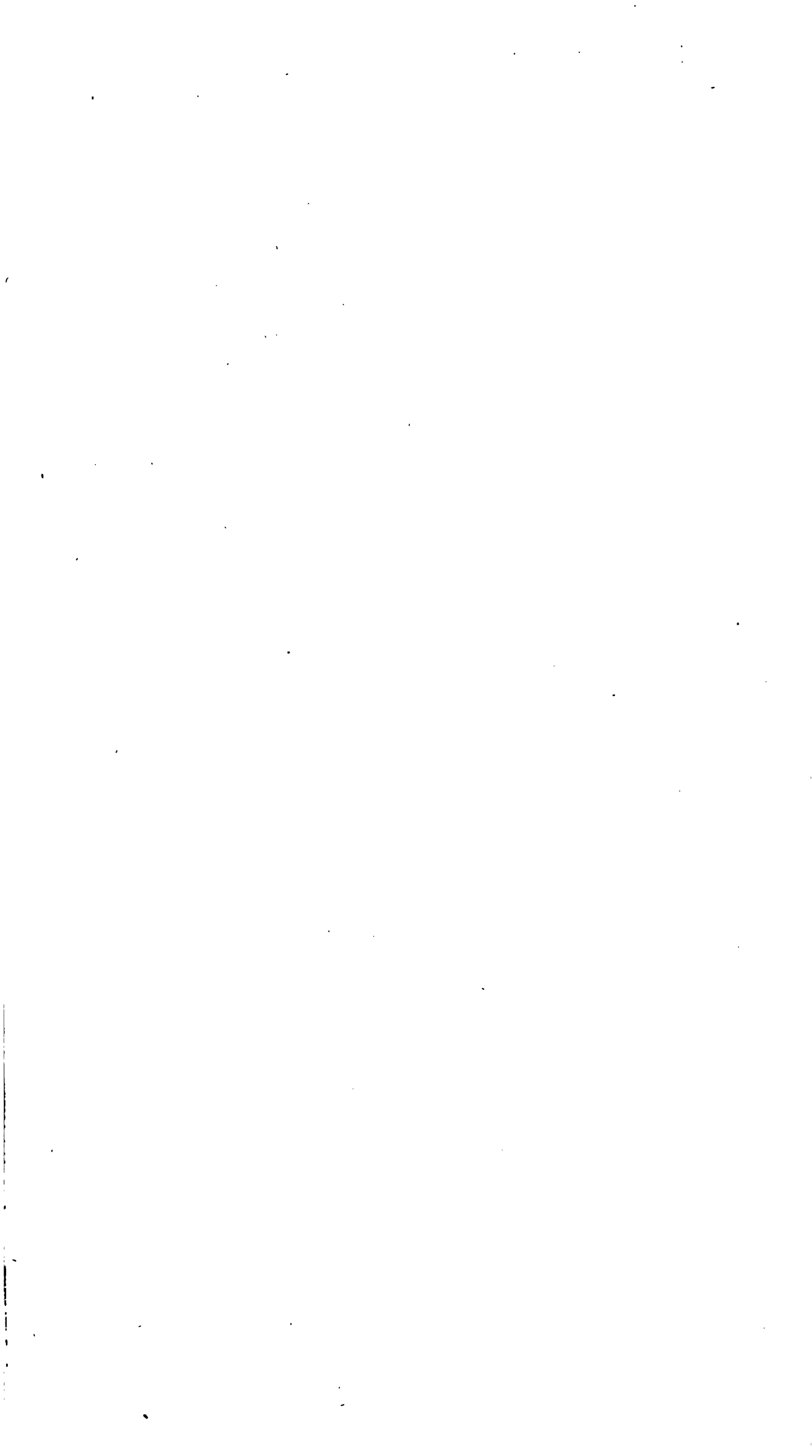

**SQUARE N°557**

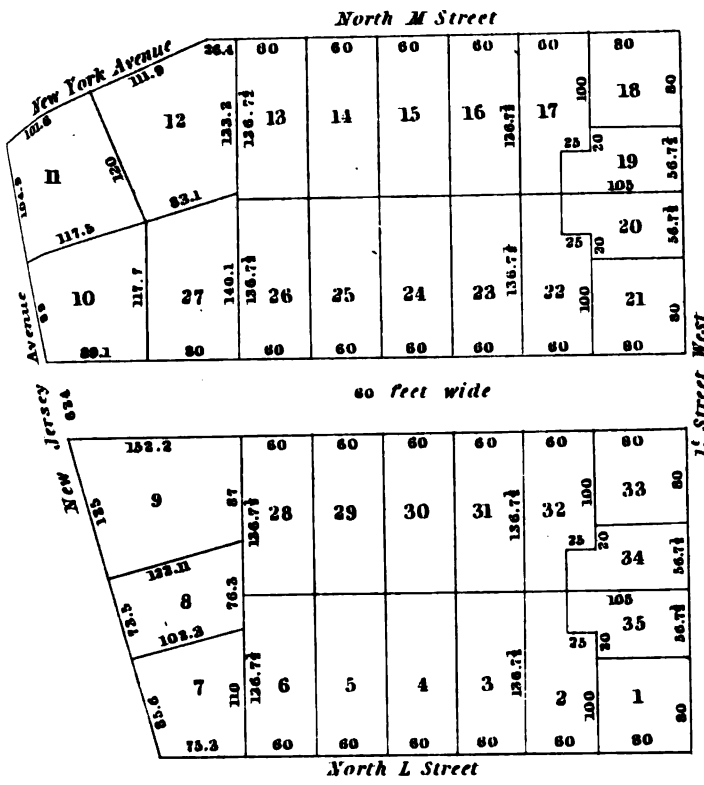

**SQUARE N°558**

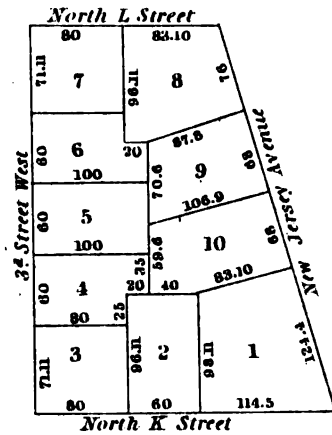

**SQUARE S. OF N°562**

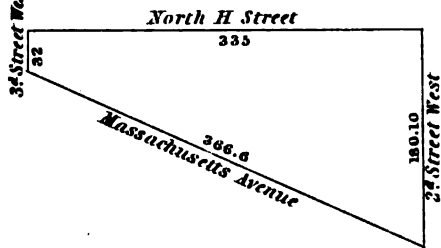

**SQUARE N°560**

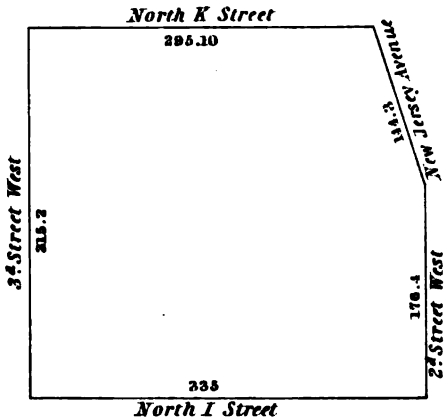

**SQUARE N°559**

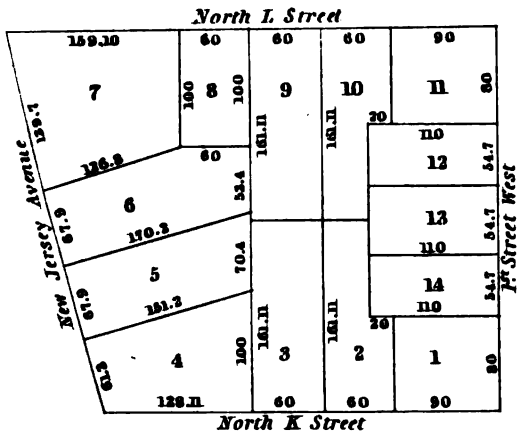

**SQUARE N°562**

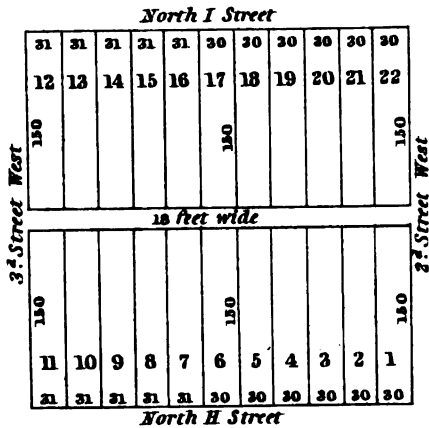

**SQUARE N°561**

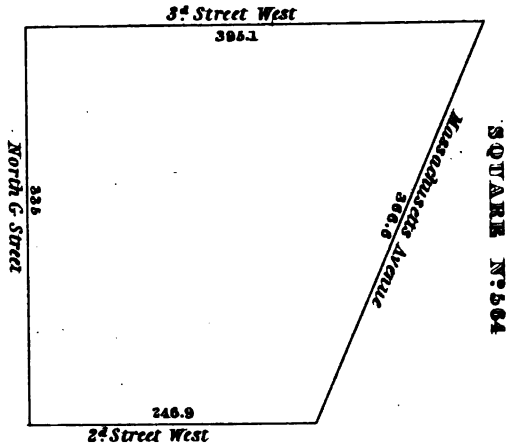
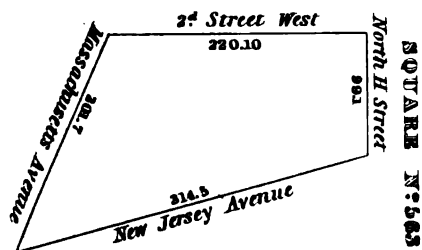
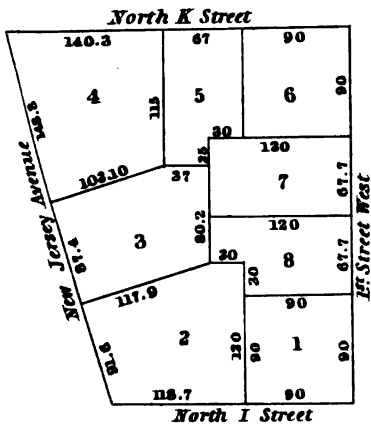





SQUARE N°585

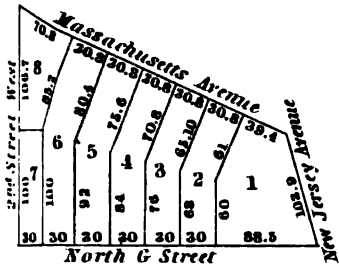

SQUARE N°571

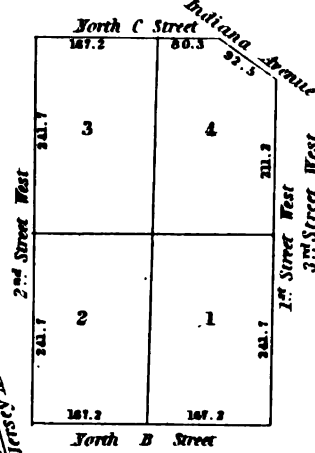

SQUARE N°588

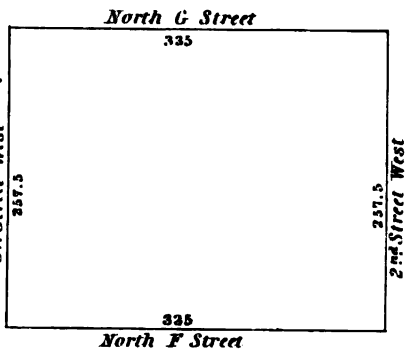

SQUARE N°581

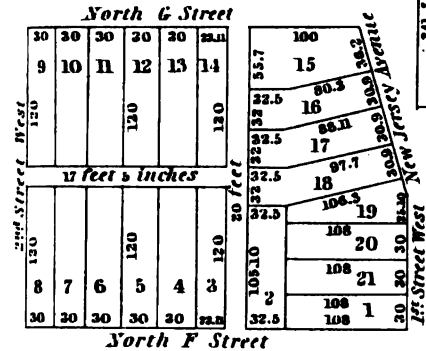

SQUARE N°588

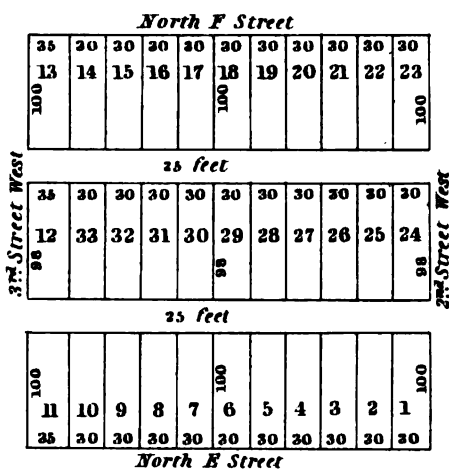

SQUARE N°589

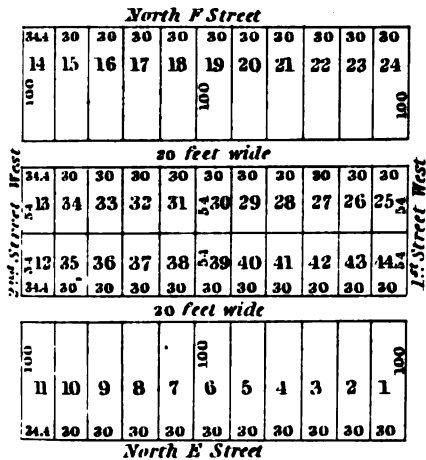

SQUARE N°570

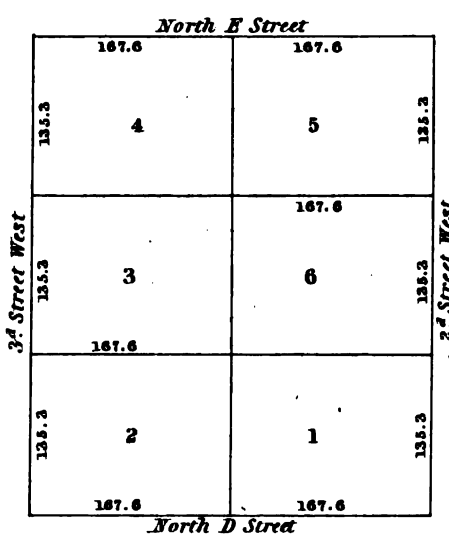

SQUARE N°571

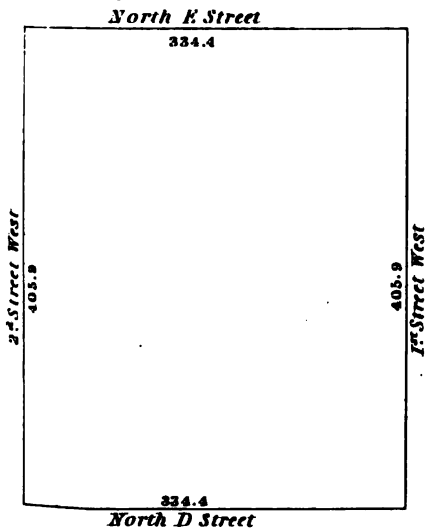

SQUARE N°572

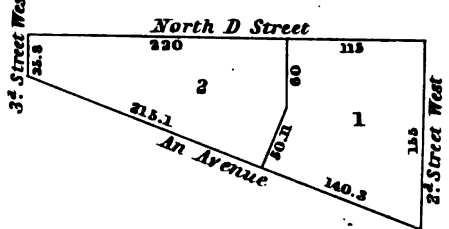

SQUARE N°573

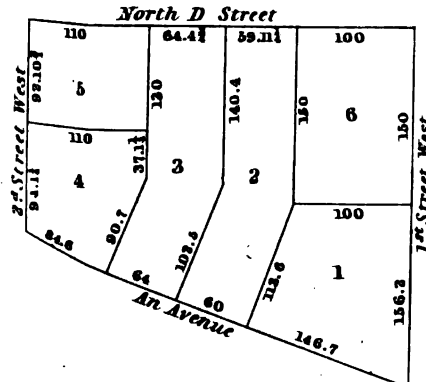

SQUARE S. OF N°572

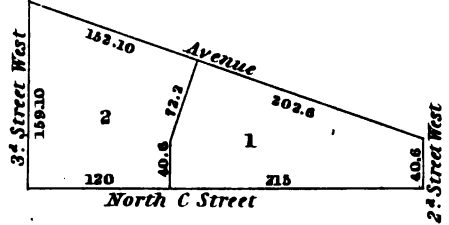



SQUARE N:575

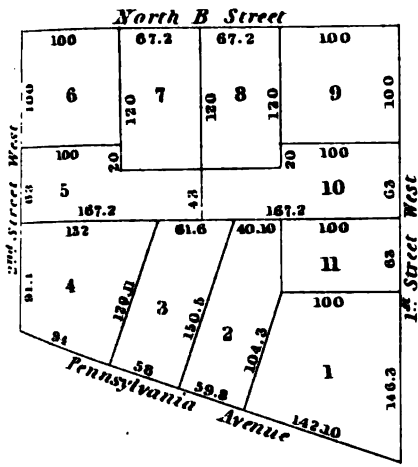

South B Street

SQUARE N:577

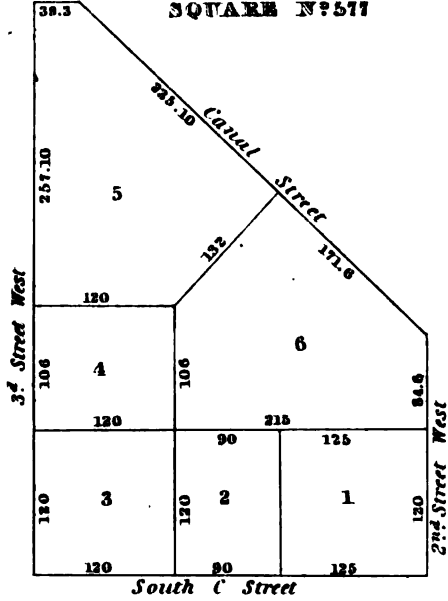

SQUARE N:576

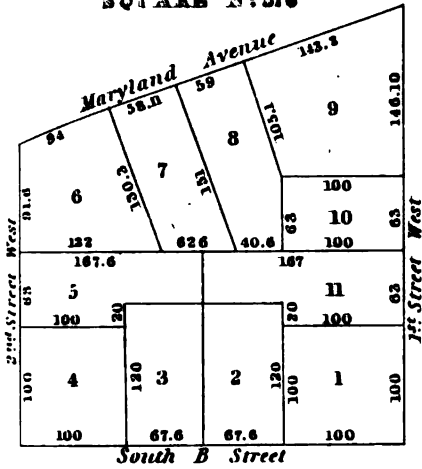

SQUARE N:578

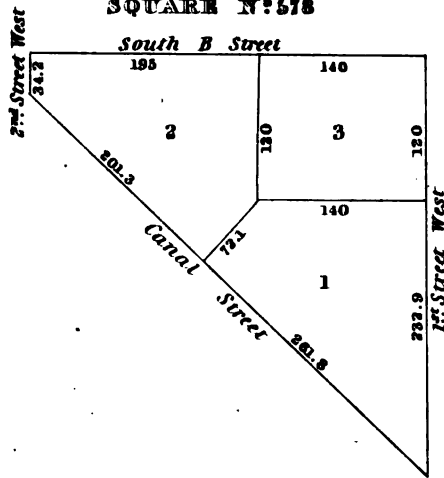

SQUARE N. OF N:580

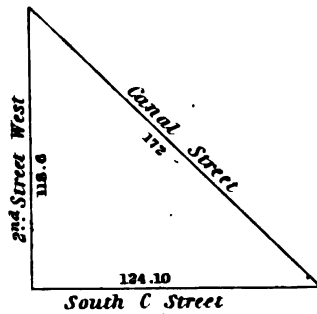

SQUARE N:579

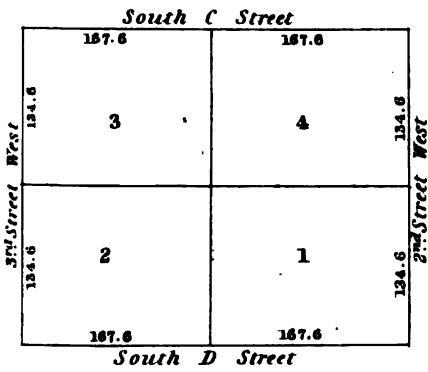

SQUARE N:581

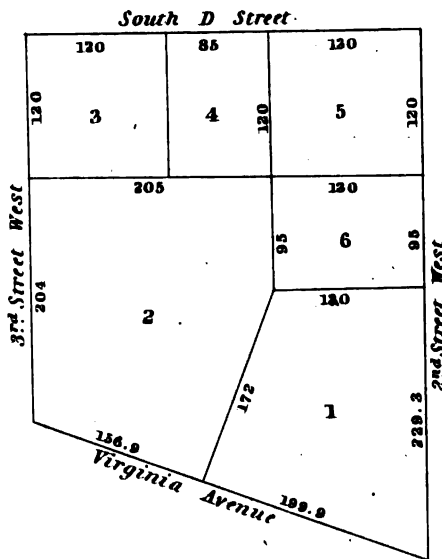

SQUARE N:580

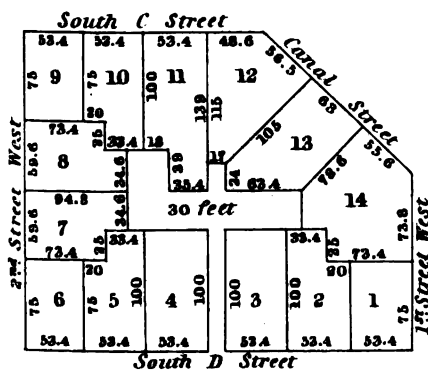

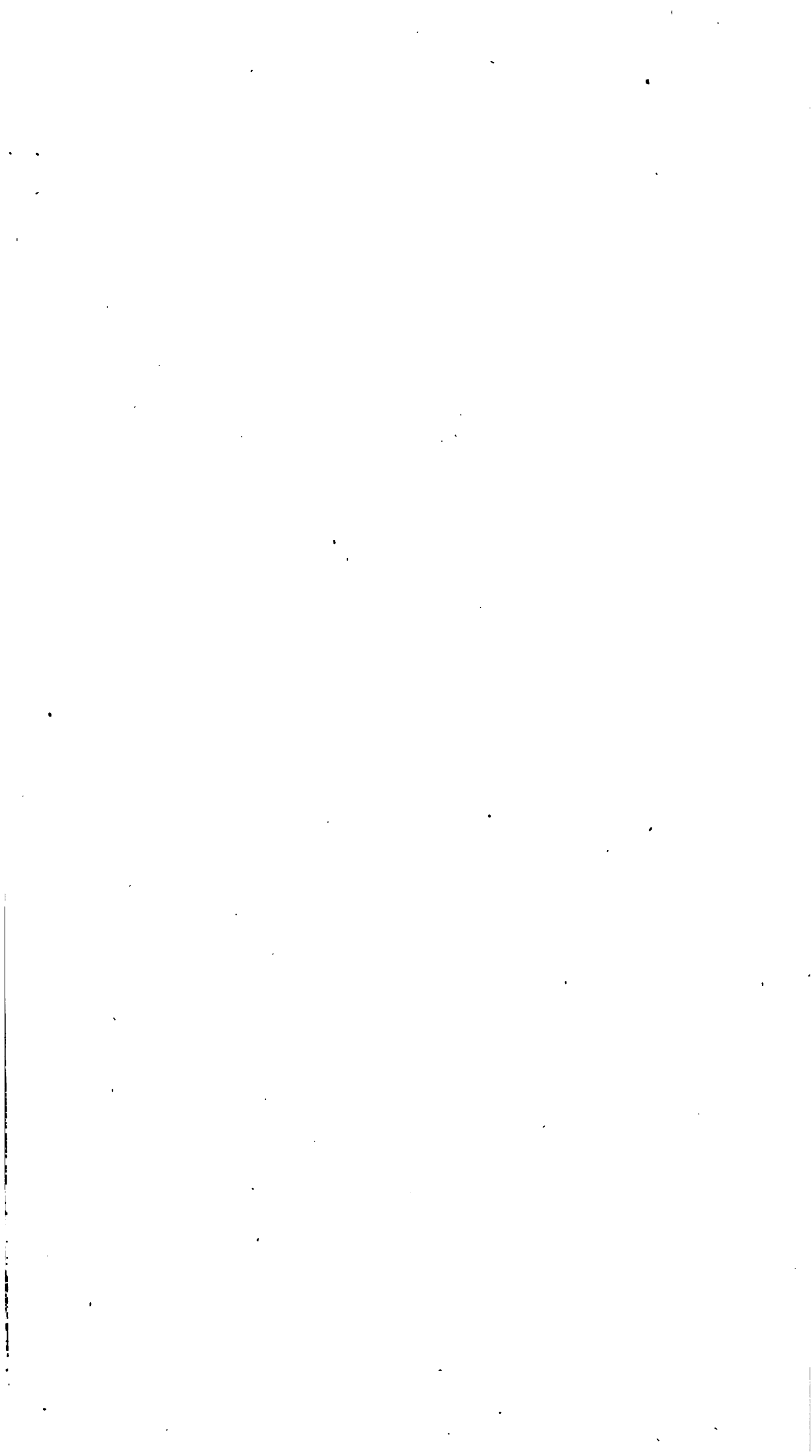

**SQUARE N:582**

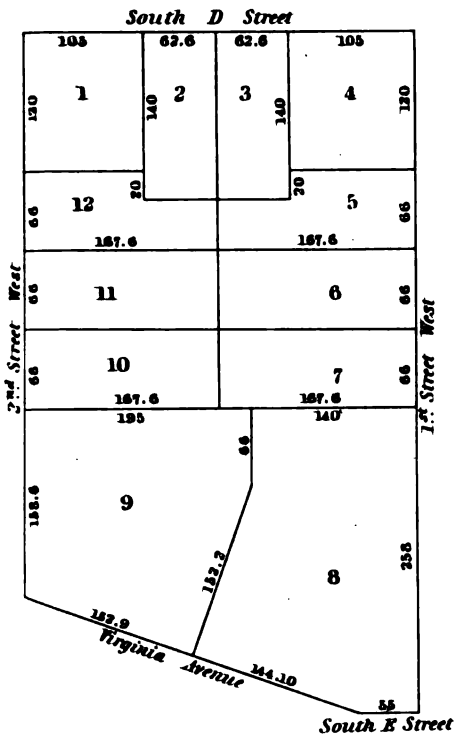

**SQUARE N. OF N:583**

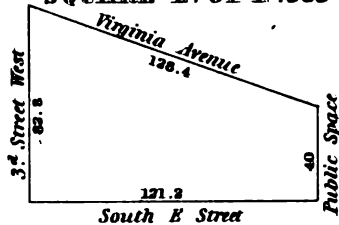

**SQUARE N:583**

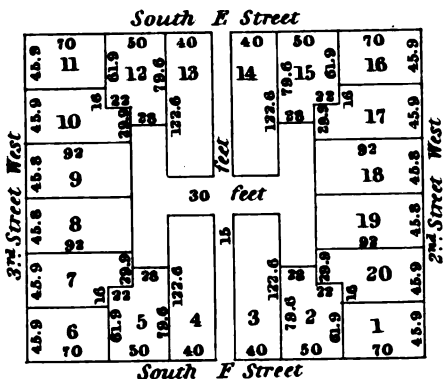

**SQUARE N:584**

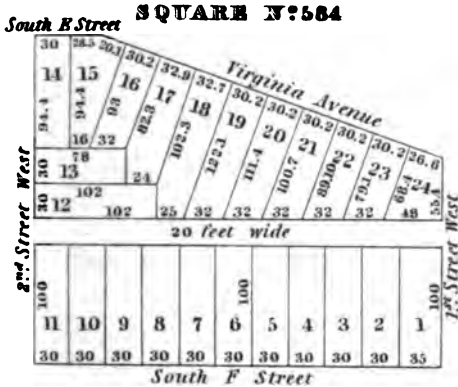

**SQUARE N:585**

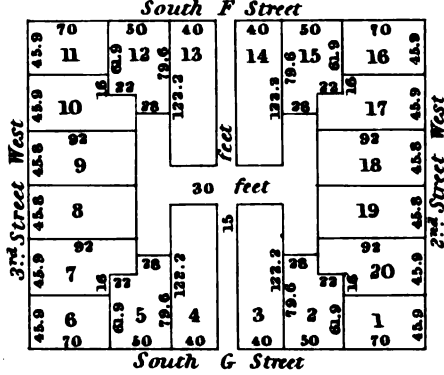

**SQUARE N:586**

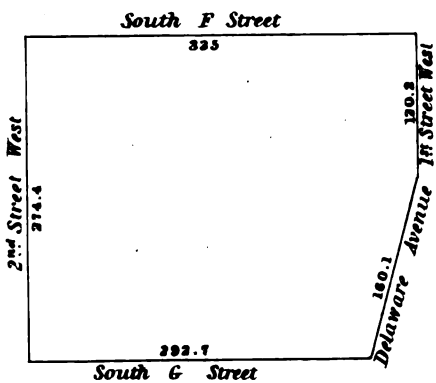

**SQUARE N:587**

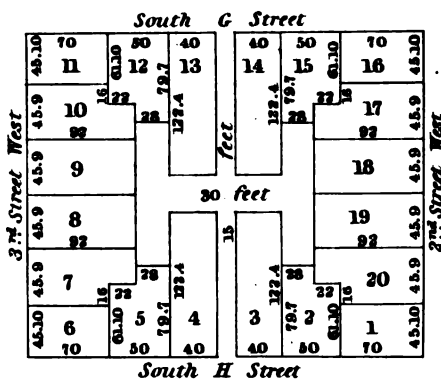

**SQUARE N:588**

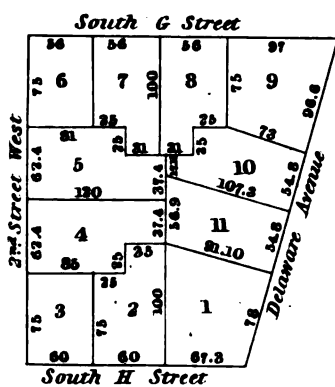

**SQUARE N:589**

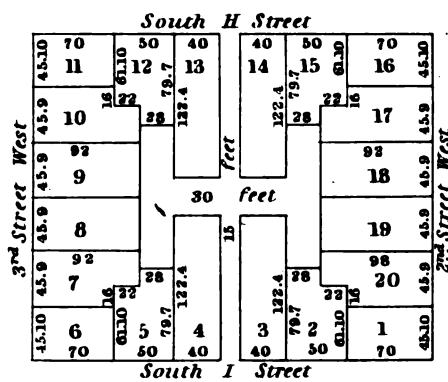



**SQUARE N°590**

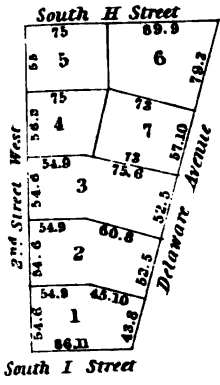

**SQUARE E. OF N°590**

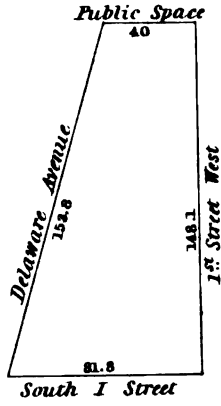

**SQUARE N°592**

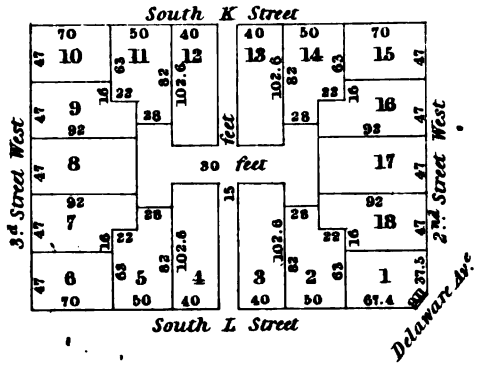

**SQUARE N°593**

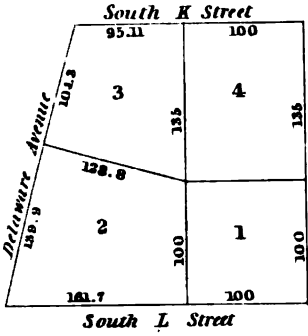

**SQUARE N°594**

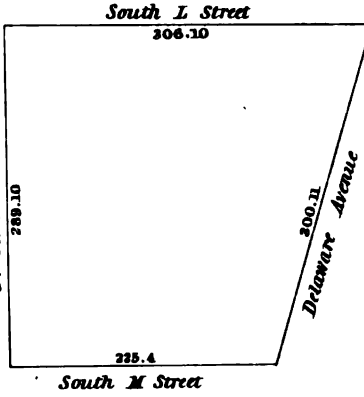

**SQUARE N°596**

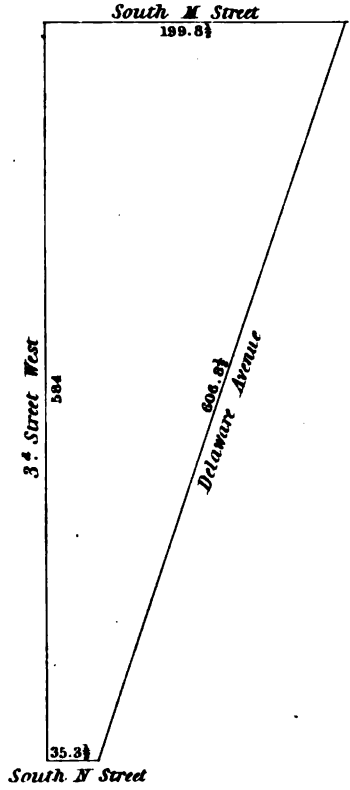

**SQUARE N°599**

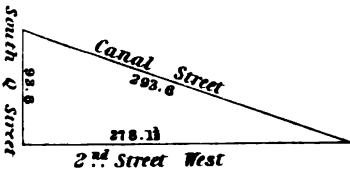
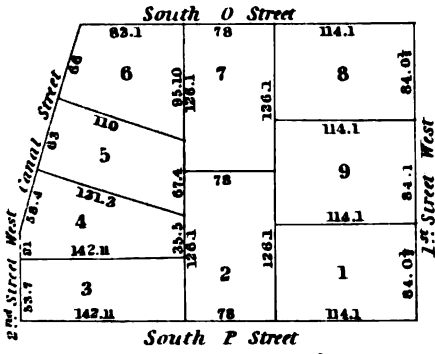

**SQUARE N°600**

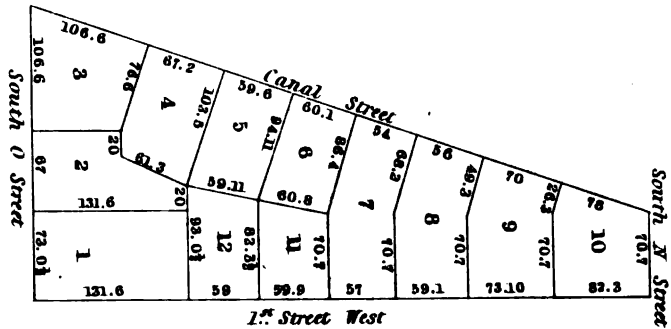

**SQUARE N°608**

**SQUARE N°601**

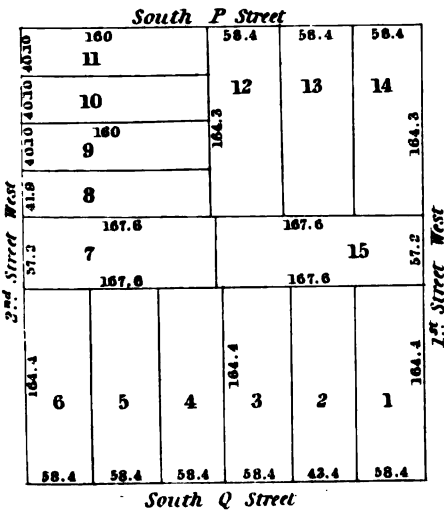

**SQUARE W. OF N°601**

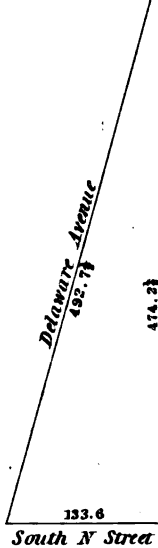

**SQUARE N°606**

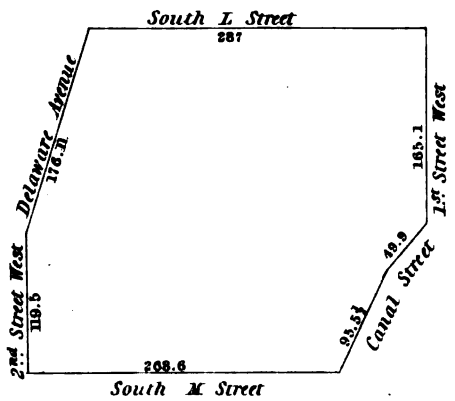



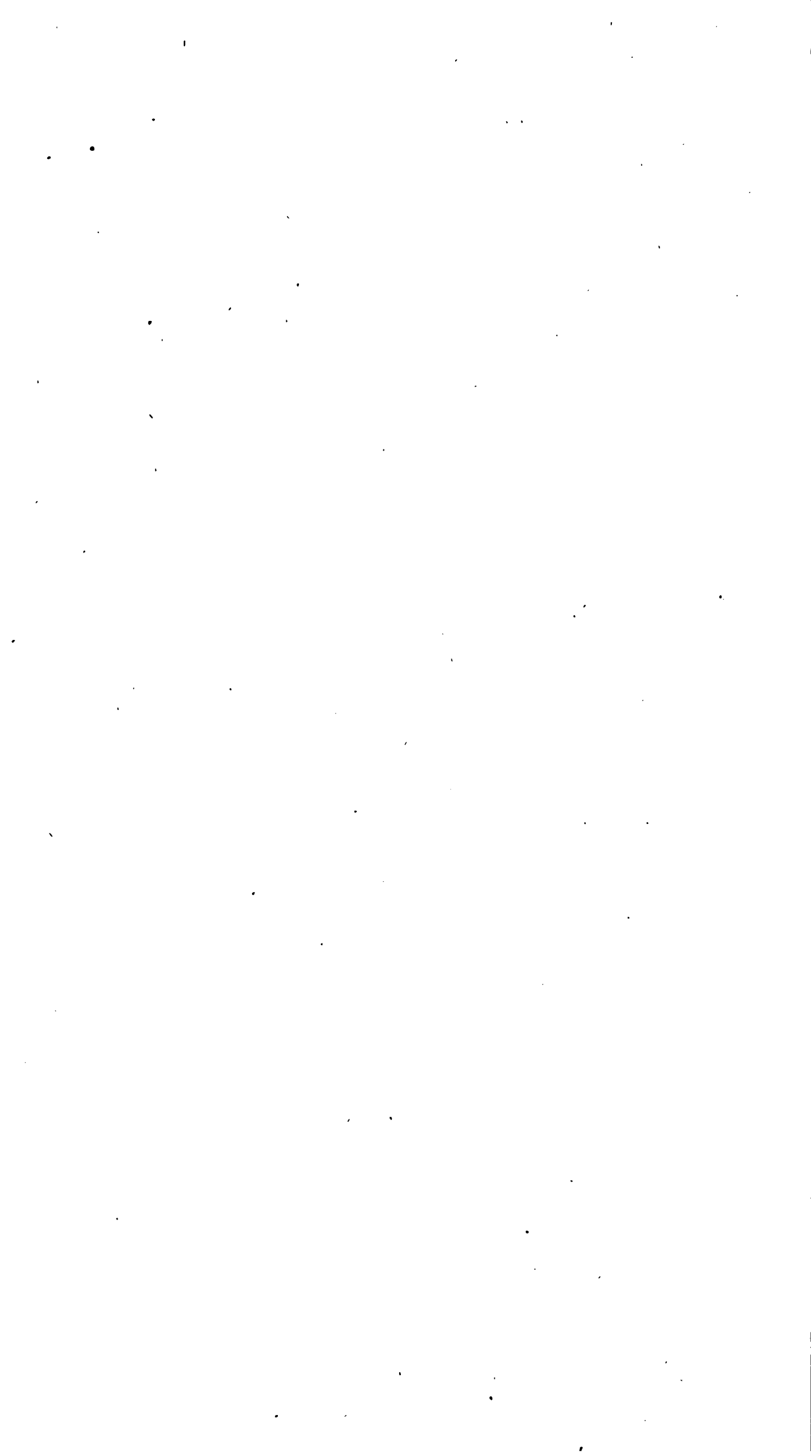

**SQUARE N:602**

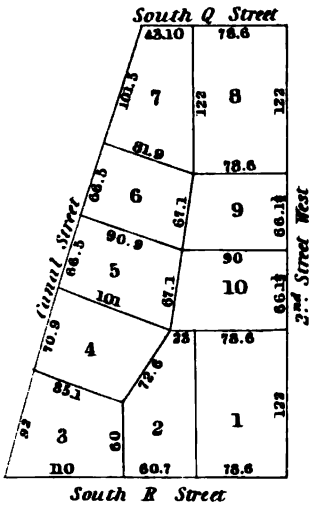

**SQUARE N:603**

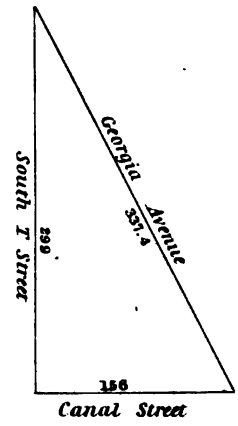
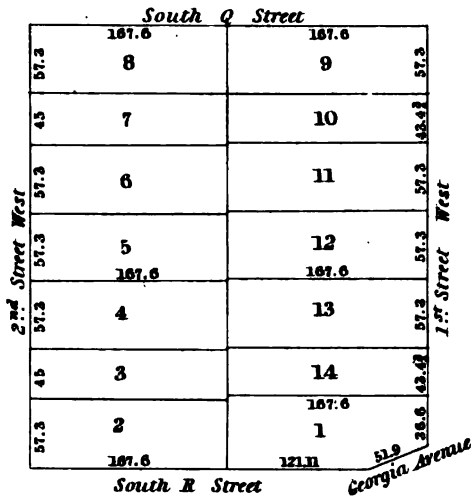

**SQUARE W. OF N:603**

**SQUARE N:601**

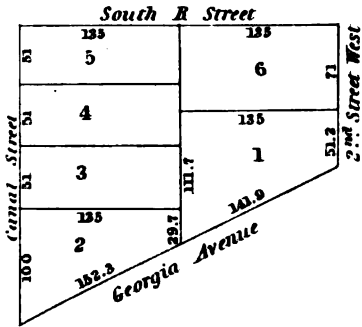

**SQUARE W. OF N:601**

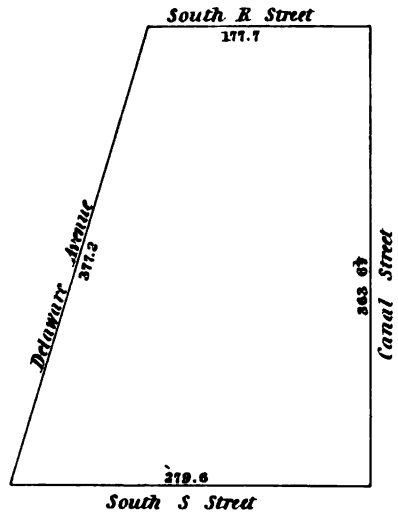

**SQUARE N:605**

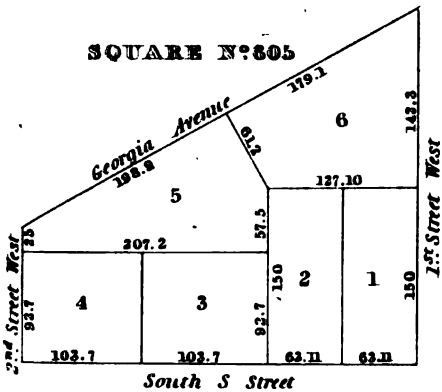

**SQUARE N:608**

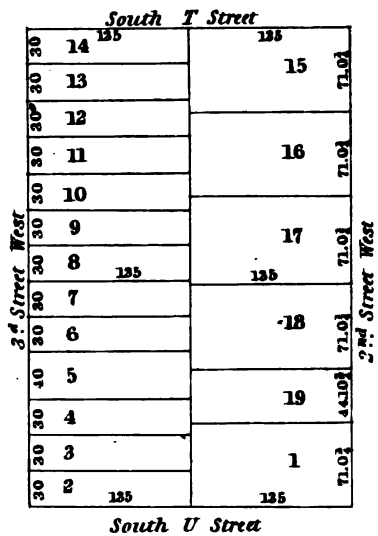

**SQUARE N:606**

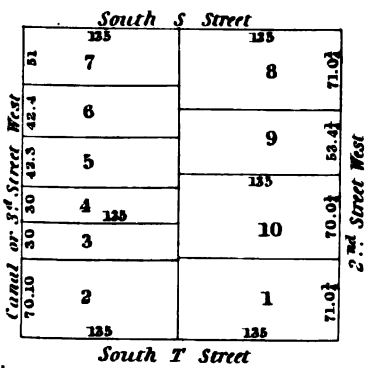

**SQUARE N:607**

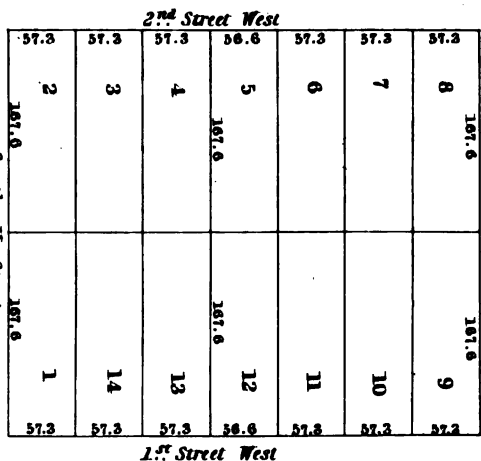
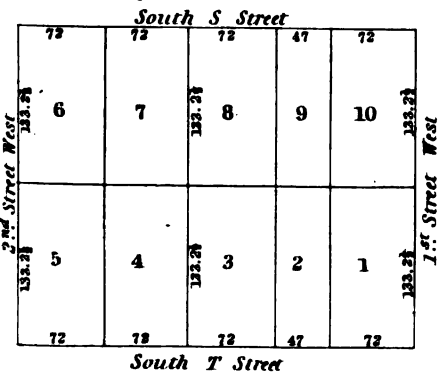

**SQUARE N:609**



SQUARE N° 611

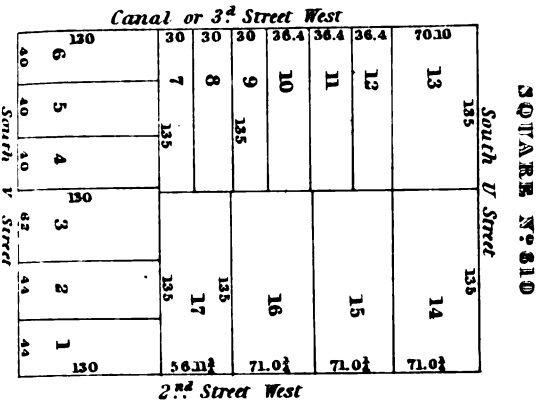
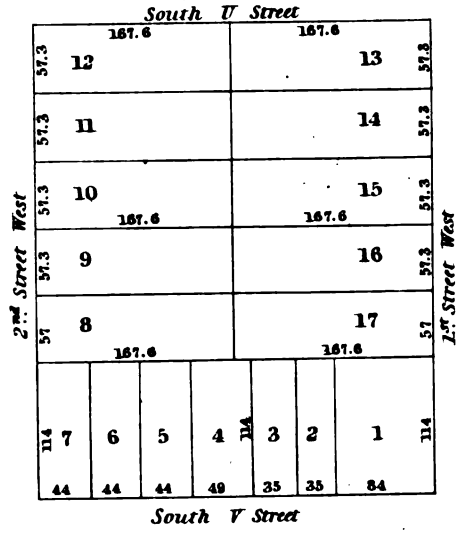

SQUARE N° 613

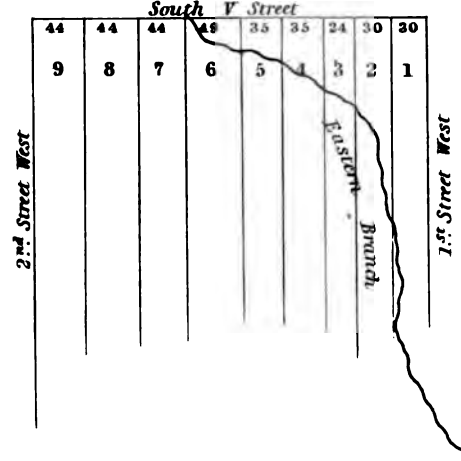

SQUARE N° 612

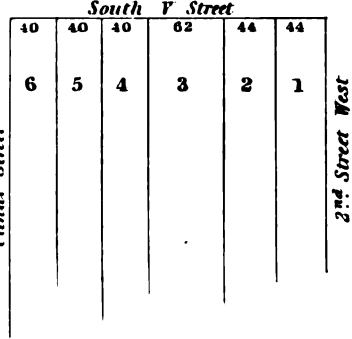

SQUARE N° 614

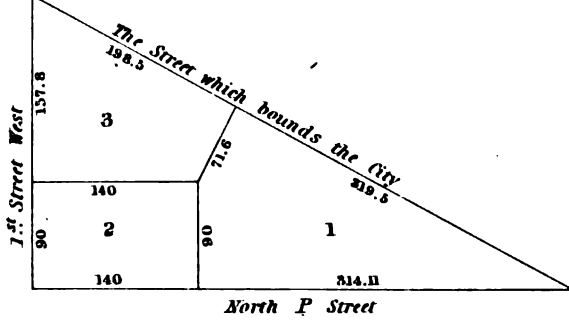

SQUARE N° 615

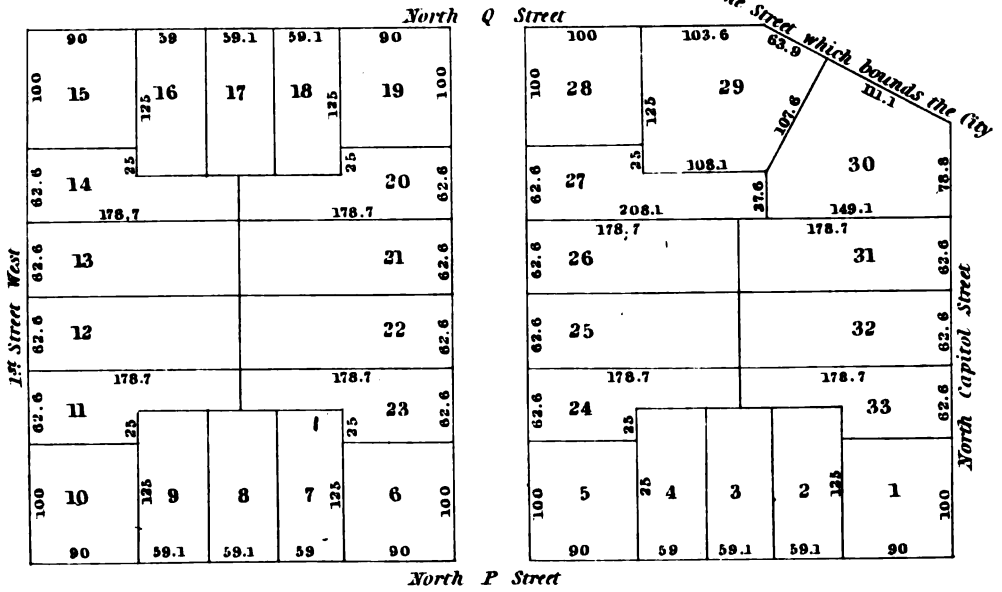



**SQUARE N° 816**

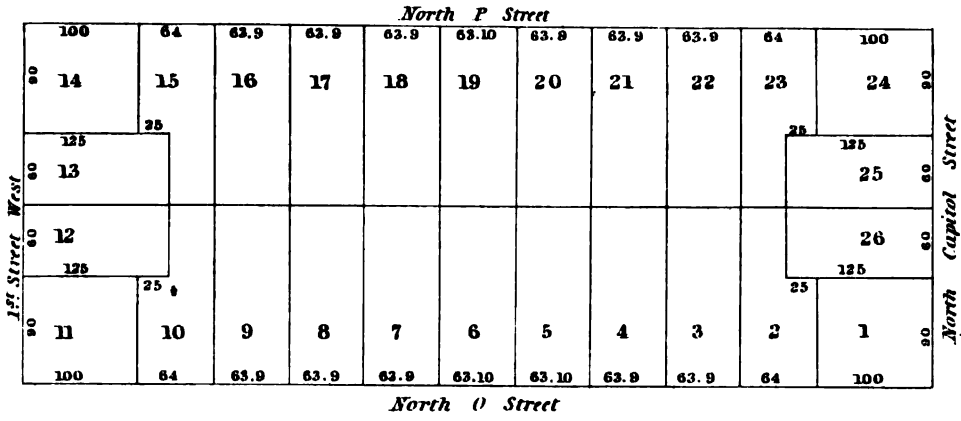

**SQUARE N° 817**

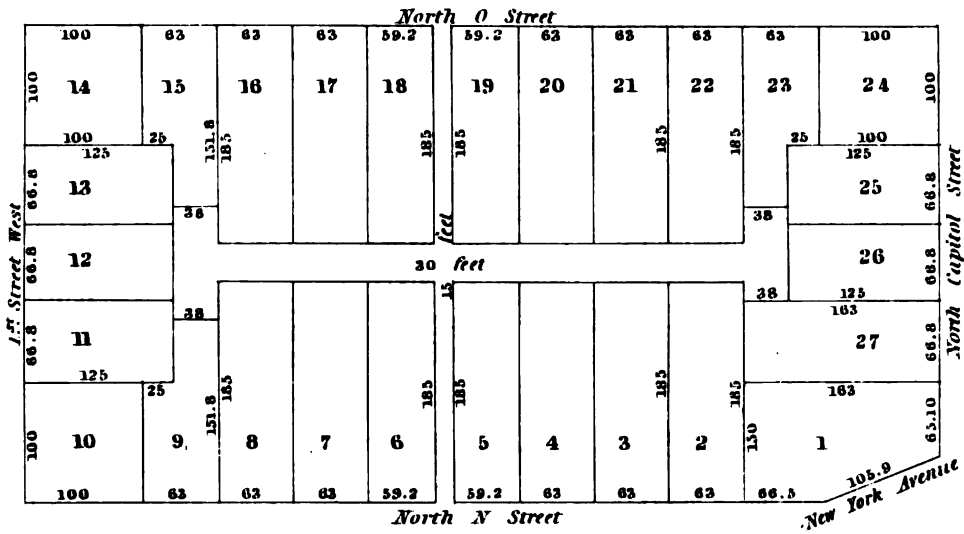

**SQUARE N° 818**

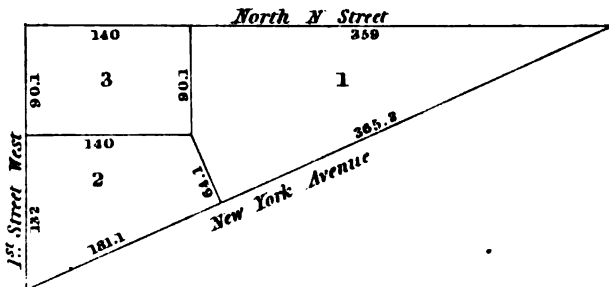

**SQUARE N° 819**

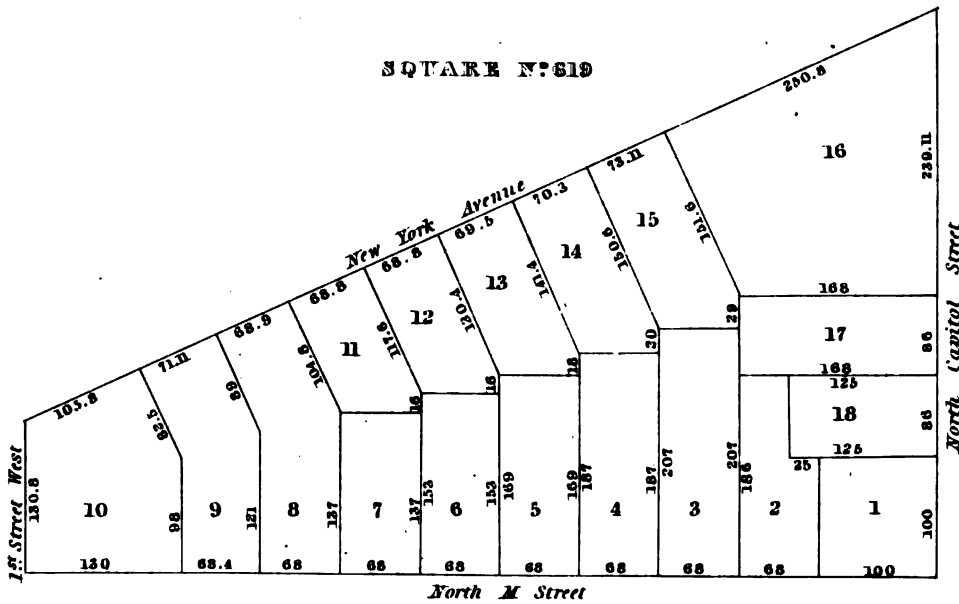



SQUARE N: 820

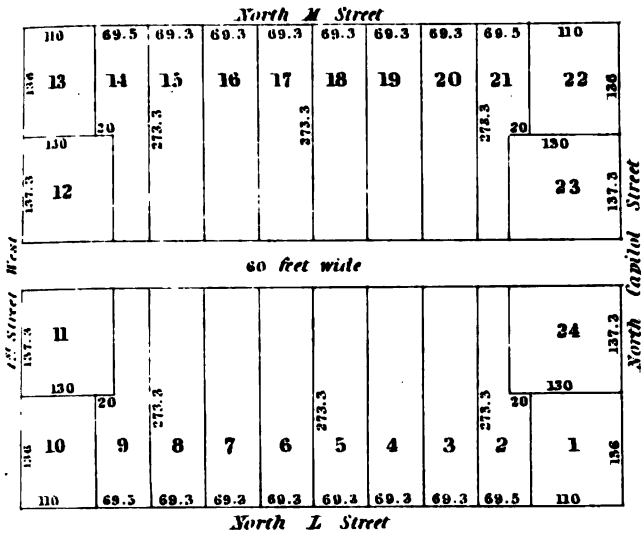

SQUARE W. OF N: 823

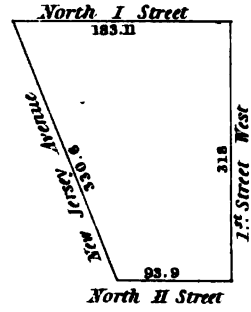

SQUARE N: 821

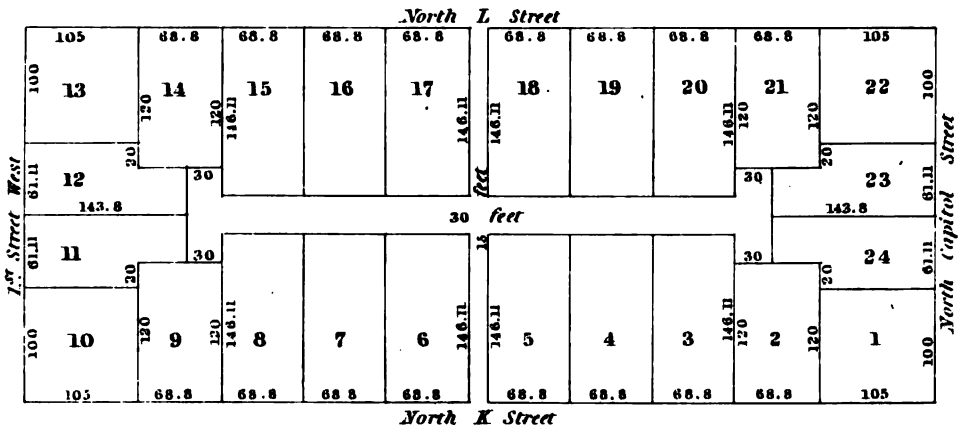

SQUARE N: 822

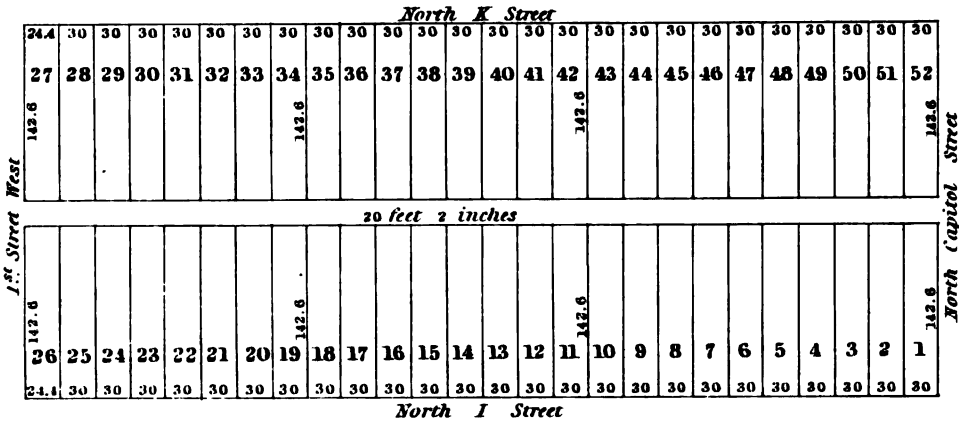

SQUARE N: 823

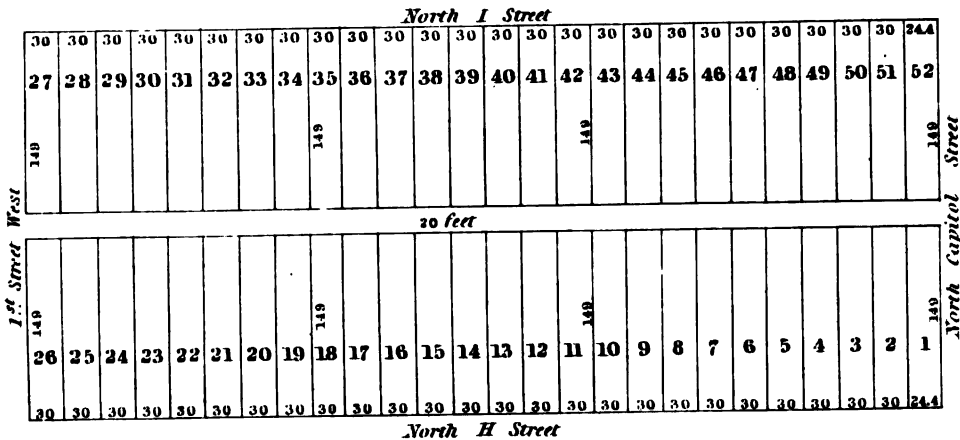





SQUARE W. OF N: 824

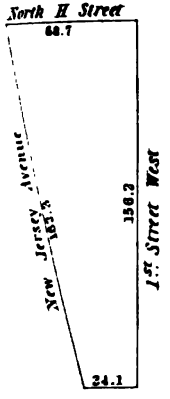

SQUARE N: 824

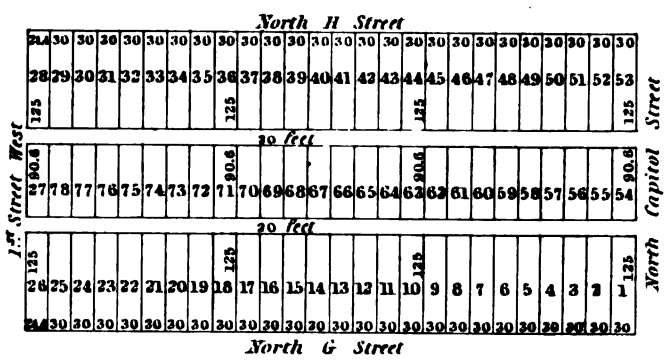

SQUARE N: 829

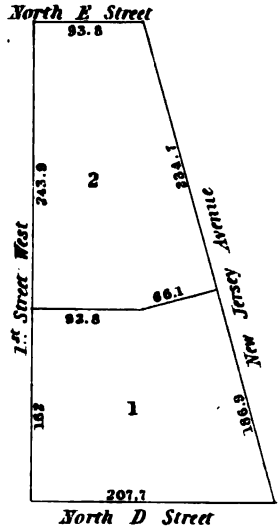

SQUARE N: 825

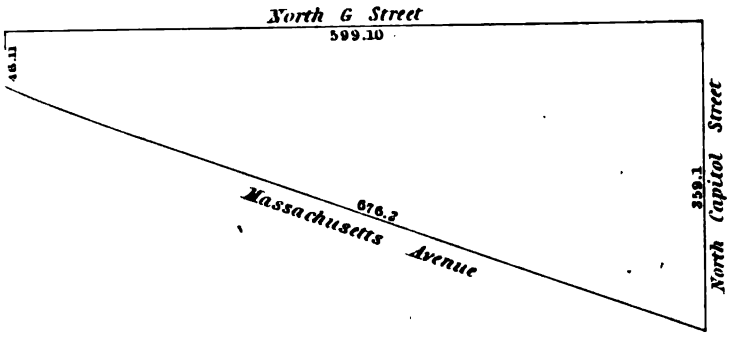

SQUARE N: 827

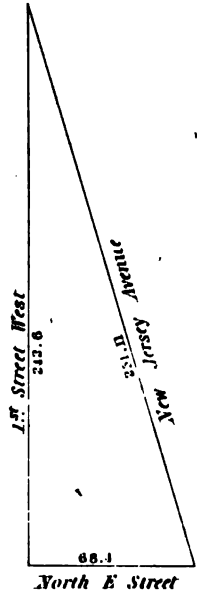

SQUARE N: 826

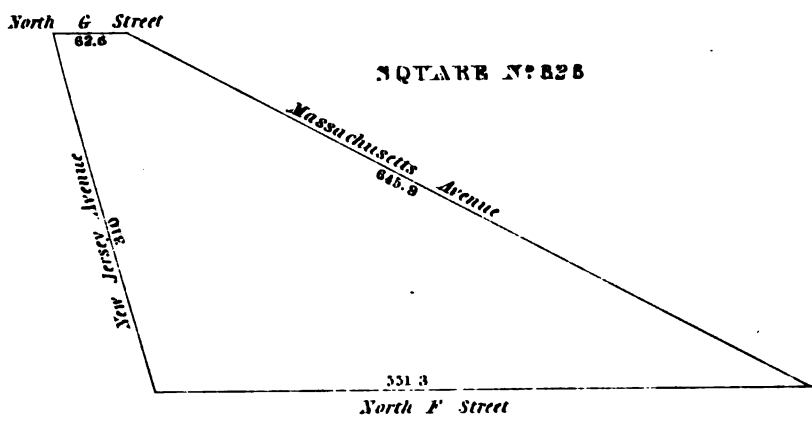

SQUARE N: 828

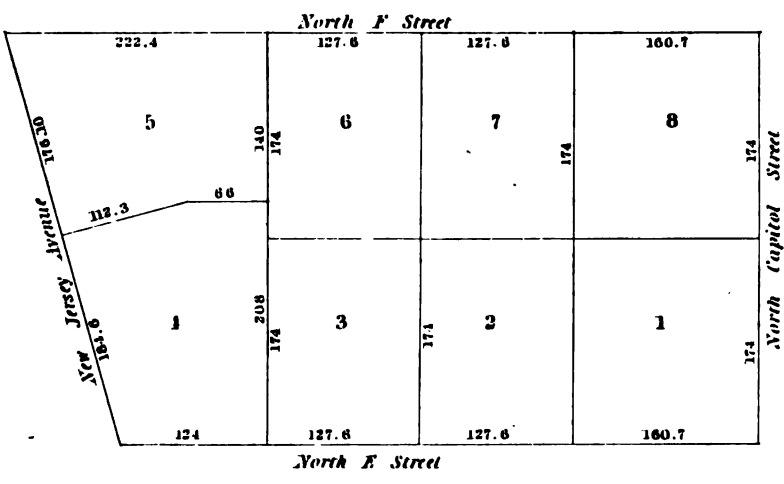



SQUARE N:630

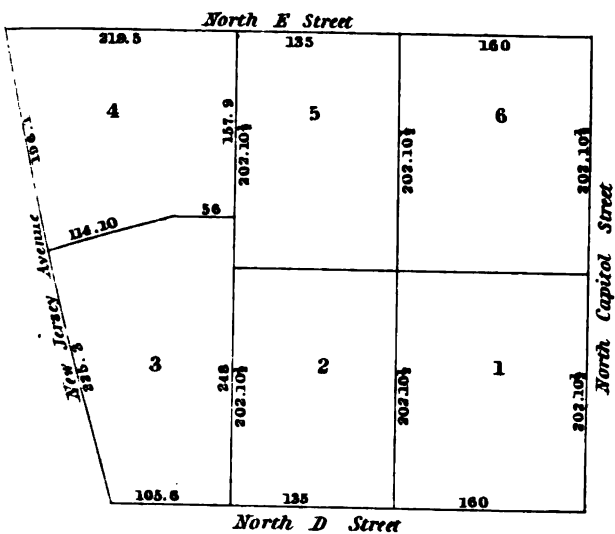

SQUARE N:631

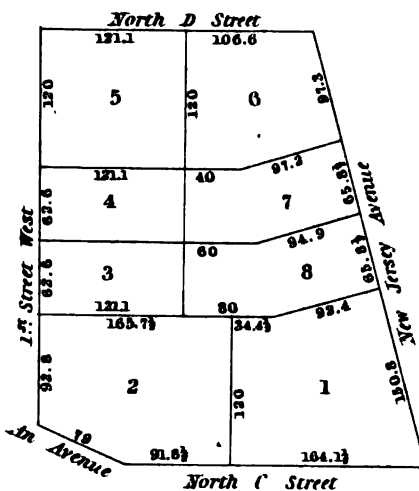

SQUARE N:632

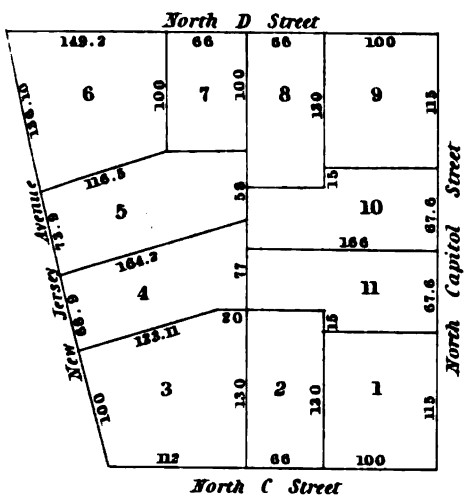

SQUARE N:633

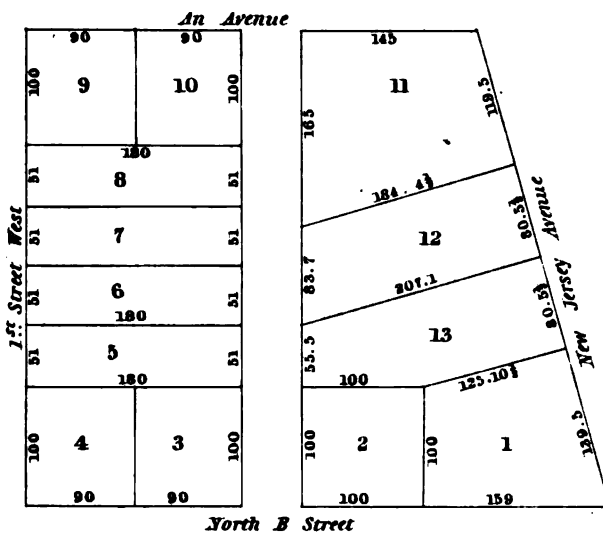

SQUARE N:634

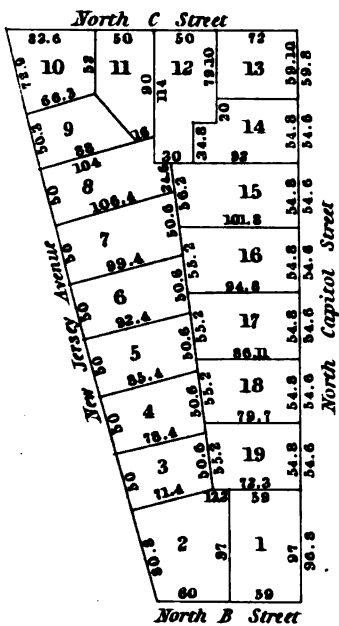

SQUARE N:635

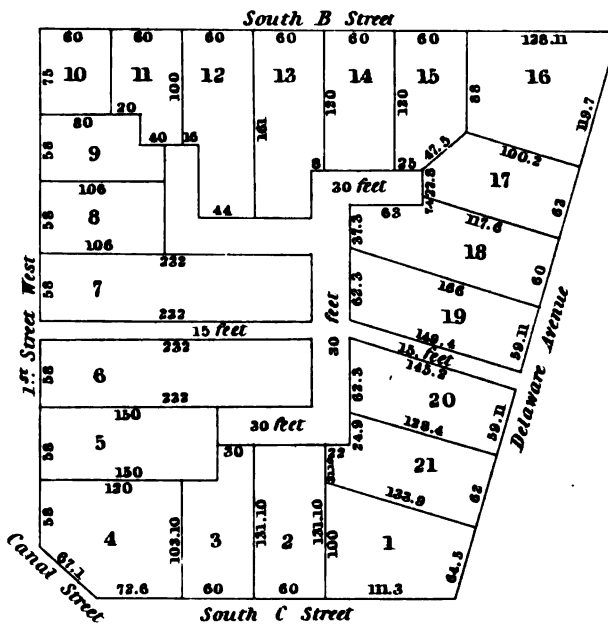

SQUARE S. OF N:635

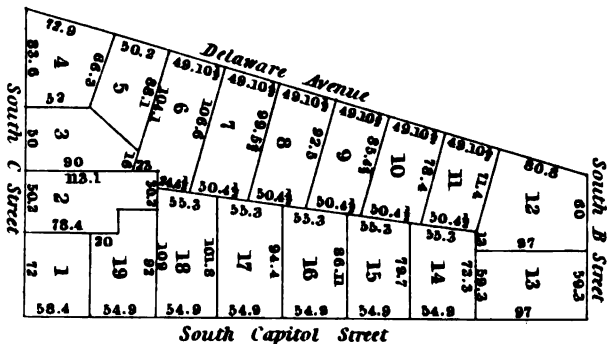
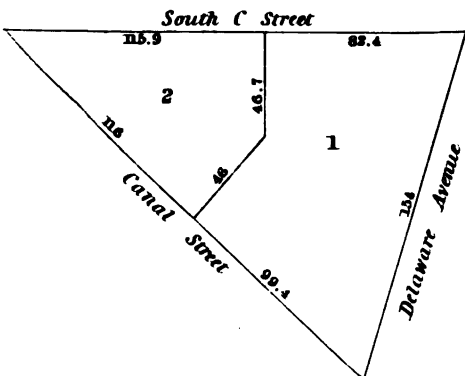

SQUARE N:635

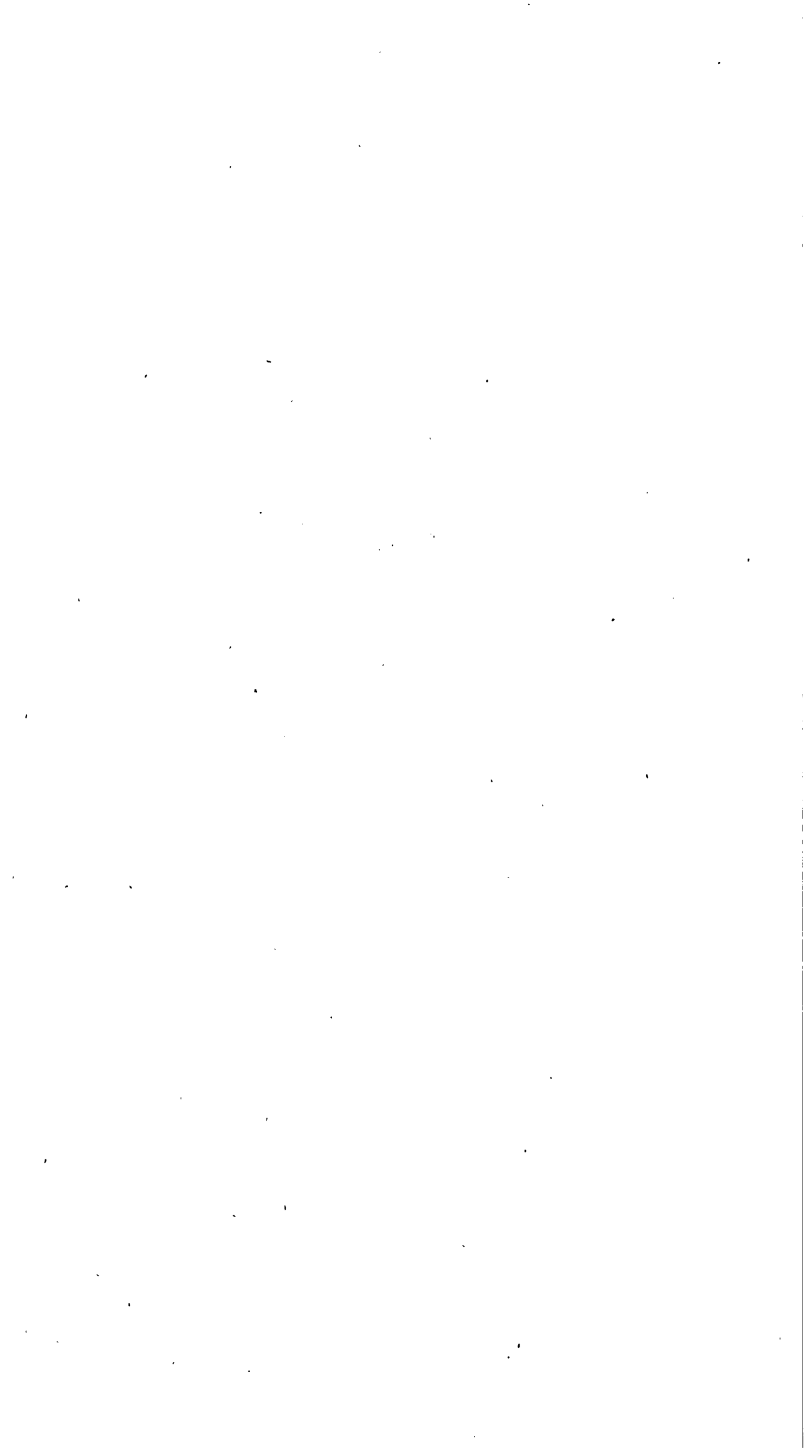

SQUARE N:637

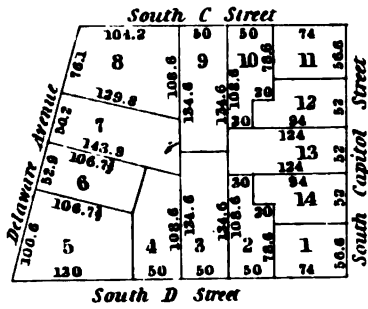

SQUARE N:639

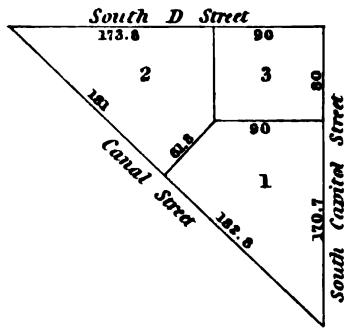

SQUARE N:638

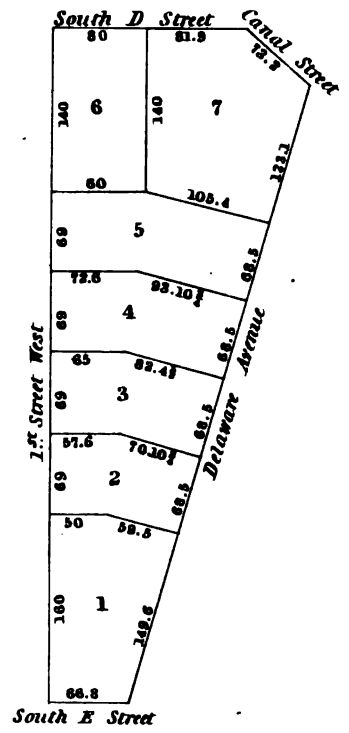

SQUARE N:641

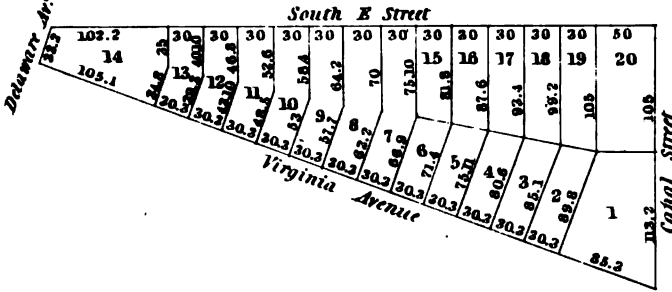

SQUARE N:642

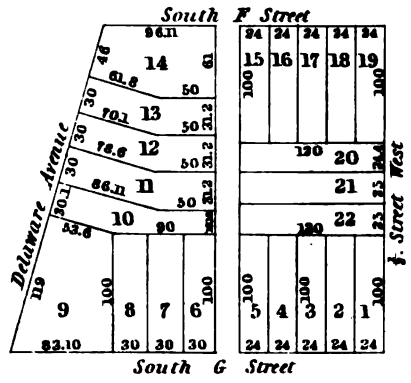

SQUARE N:640

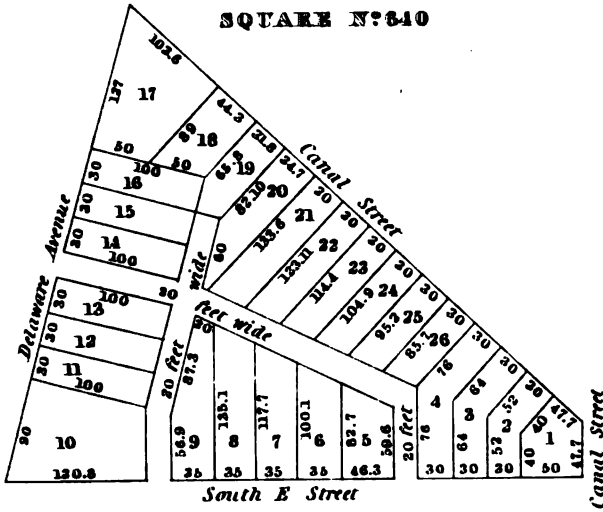

SQUARE N:643

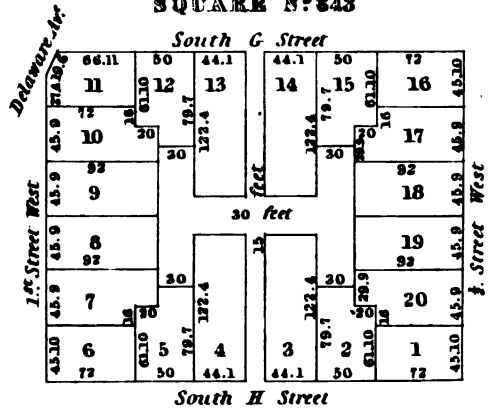

SQUARE E. OF N:642

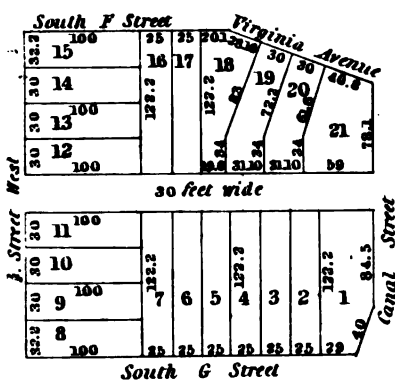

SQUARE E. OF N:643

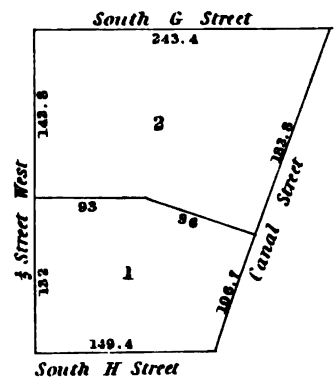

SQUARE N. OF N:642

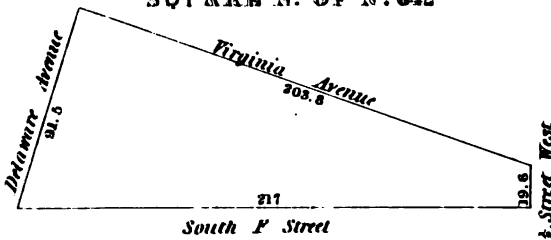



SQUARE S. OF N°643

SQUARE N°644

SQUARE W. OF N°645

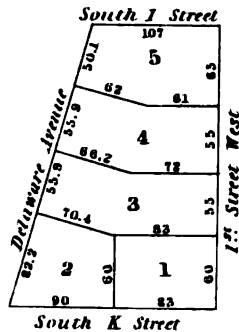
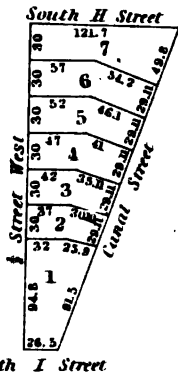
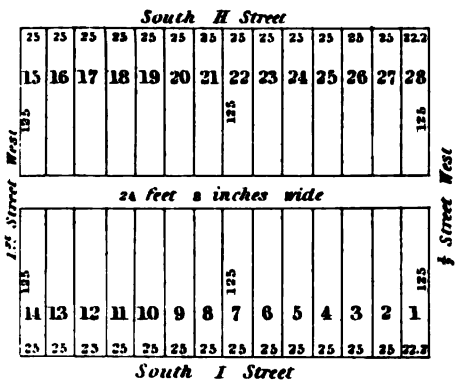

SQUARE N°646

SQUARE N°648

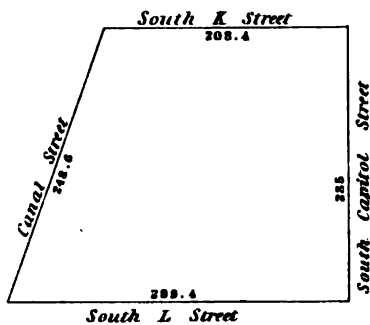

SQUARE N°645

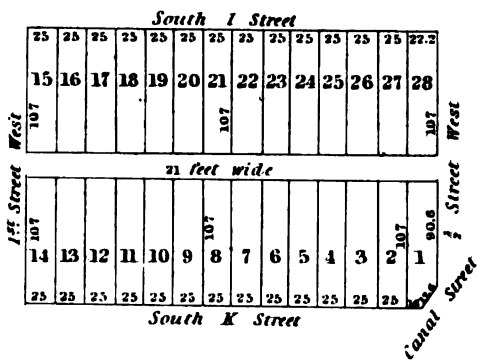

SQUARE N°647

SQUARE N. OF N°650

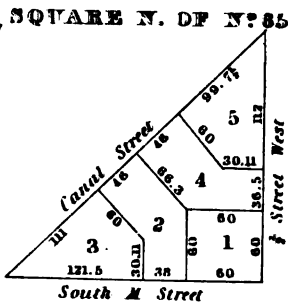
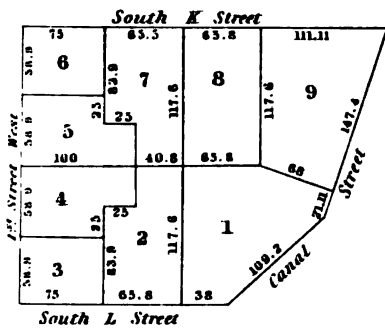

SQUARE N°649

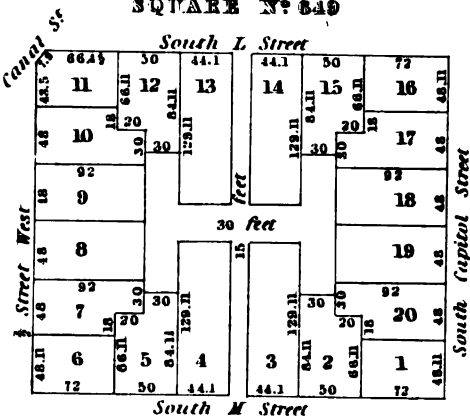

SQUARE N°65D

SQUARE N°651

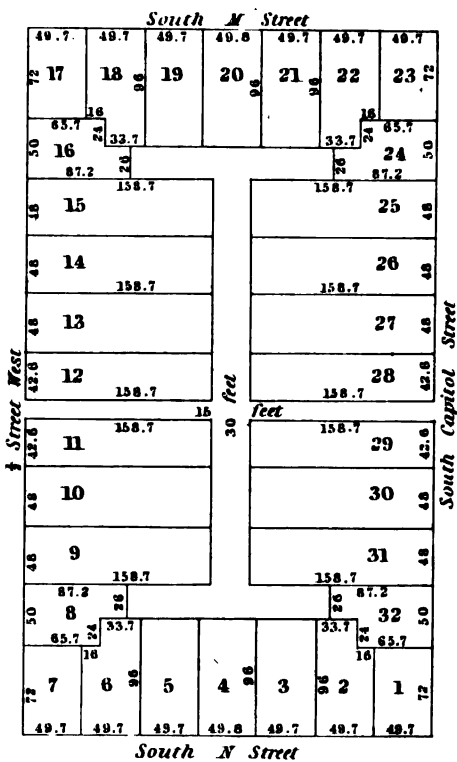
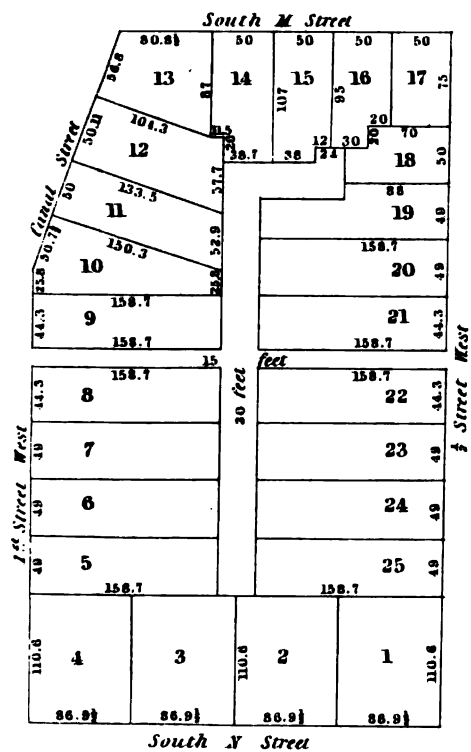



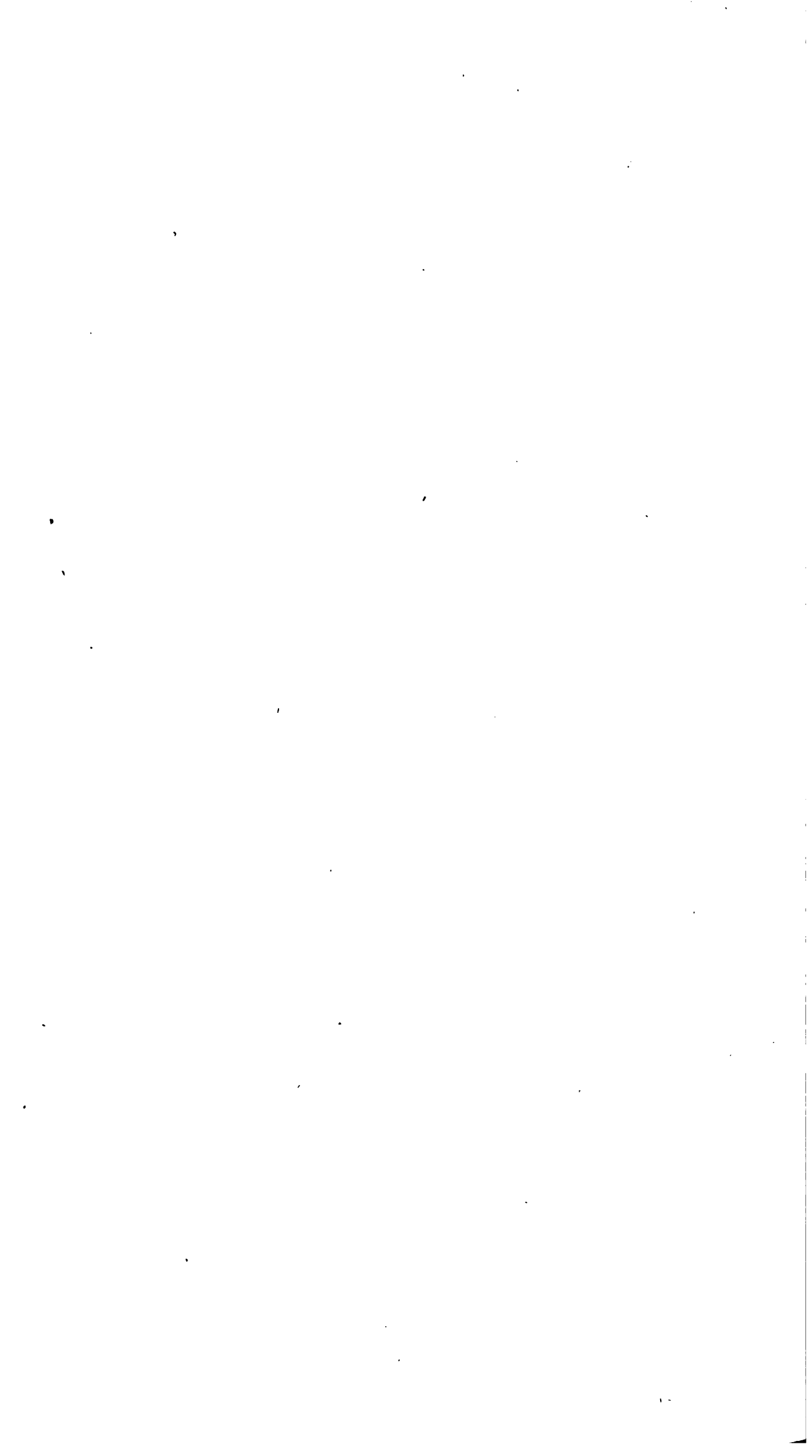

**SQUARE N° 652**

<i>South N Street</i>	
113.7	173.7
11	12
10	13
9	14
8	15
7	16
173.7	173.7
6	17
5	18
4	19
3	20
2	1
173.7	173.7
<i>South O Street</i>	

**SQUARE N° 653**

<i>South Y Street</i>	
173.7	173.7
10	11
9	12
8	13
7	14
173.7	173.7
6	15
5	16
4	17
3	18
2	19
173.7	173.7
<i>South O Street</i>	

**SQUARE N° 654**

<i>South O Street</i>	
173.7	173.7
6	7
5	8
4	9
3	10
2	1
173.7	173.7
<i>South P Street</i>	

**SQUARE N° 655**

<i>South O Street</i>	
173.7	173.7
6	7
5	8
4	9
3	10
2	1
173.7	173.7
<i>South P Street</i>	

**SQUARE N° 656**

<i>South P Street</i>	
173.7	173.7
8	9
7	10
6	11
173.7	173.7
5	12
4	13
3	14
2	1
173.7	173.7
<i>South Q Street</i>	

**SQUARE N° 657**

<i>South P Street</i>	
173.7	173.7
8	9
7	10
6	11
173.7	173.7
5	12
4	13
3	14
2	1
173.7	147.6
<i>South Q Street</i>	

**SQUARE N° 658**

<i>South R Street</i>	
105.4	105.4
4	3
210.8	73.9
194.4	62.9
5	2
197.5	62.9
6	1
185.4	62.9
<i>South Capitol Street</i>	

**SQUARE N° 658**

<i>South Q Street</i>	
173.7	173.7
5	6
4	1
173.7	110.6
3	2
173.7	110.6
<i>Georgia Avenue</i>	



**SQUARE N° 861**

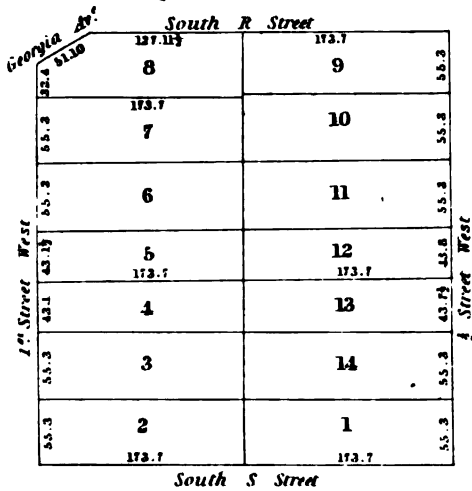

**SQUARE N° 862**

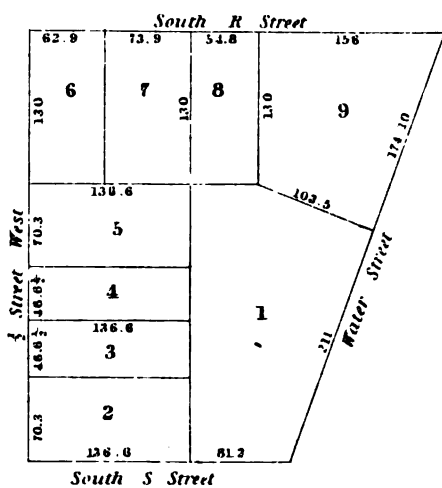

**SQUARE E. OF N° 882**

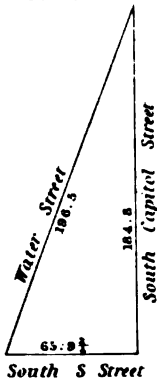

**SQUARE N° 883**

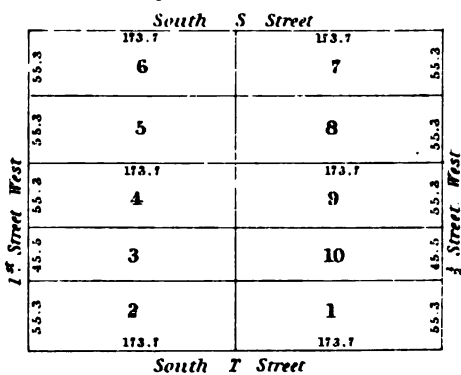

**SQUARE N° 884**

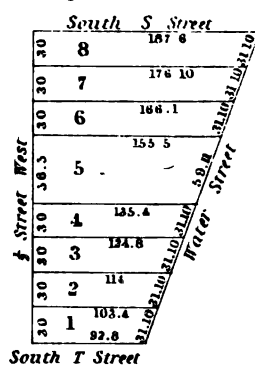

**SQUARE E. OF N° 884**

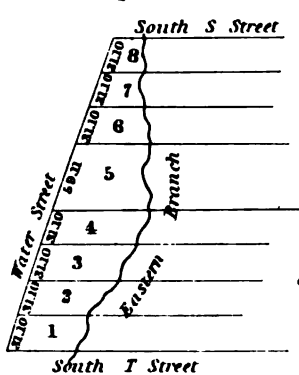

**SQUARE N° 885**

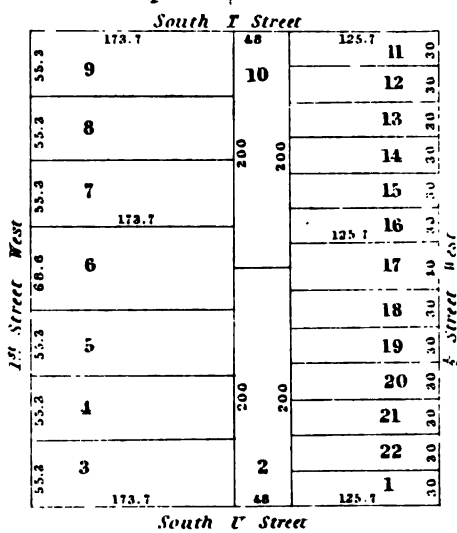

**SQUARE N° 886**

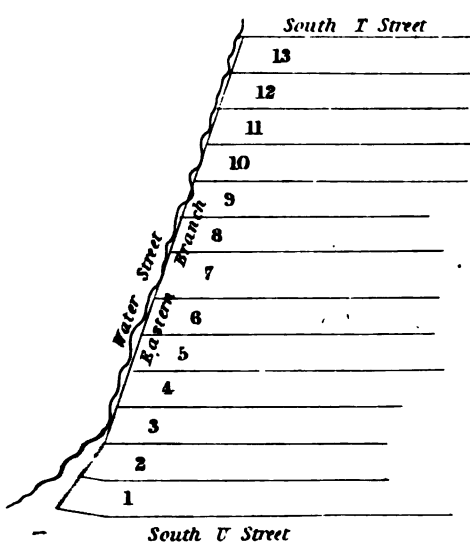

**SQUARE N° 887**

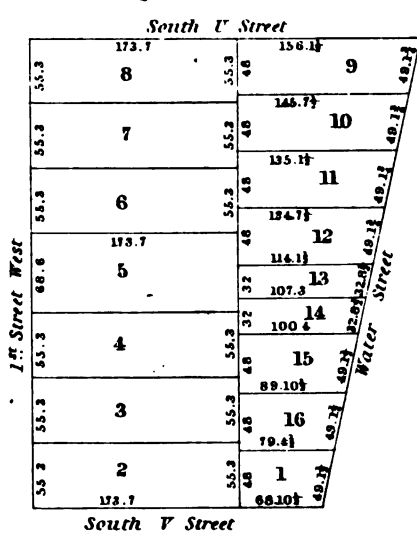



SQUARE S. OF N:687

SQUARE E. OF N:687

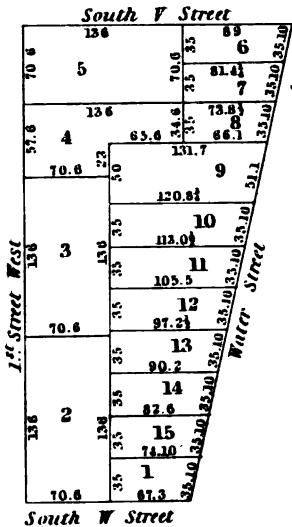
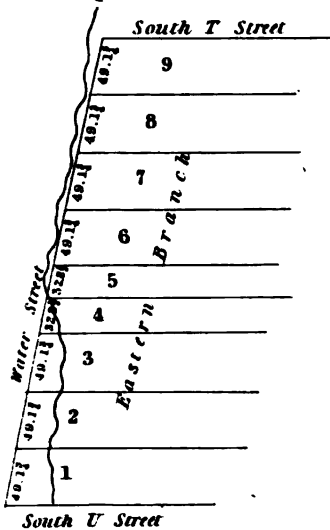

SQUARE E. OF SQUARE SOUTH OF N:687

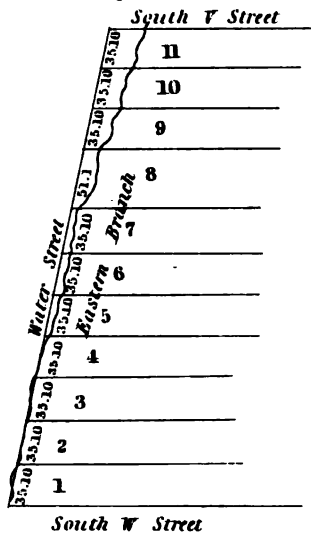

SQUARE E. OF SQUARE S. OF SQUARE S. OF N:687

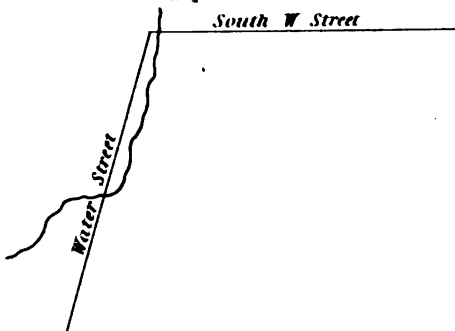

SQUARE S. OF SQUARE SOUTH OF N:687

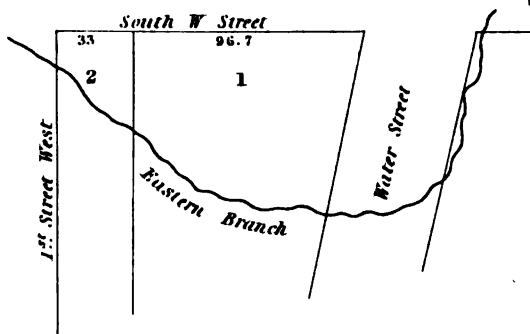

SQUARE N:688

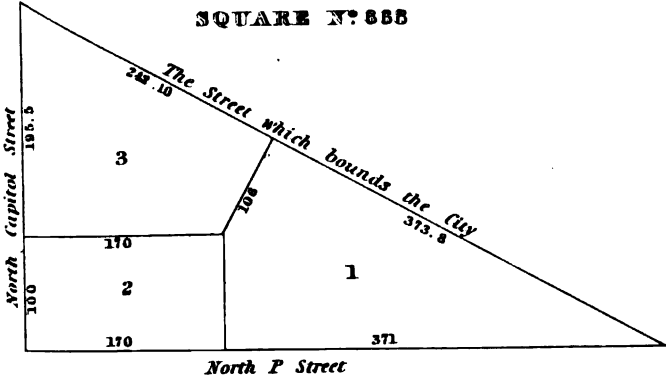

North Capitol Street

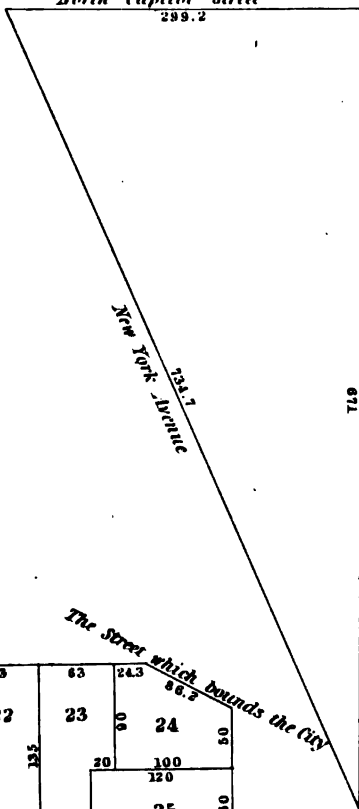

SQUARE N:610

SQUARE N:689

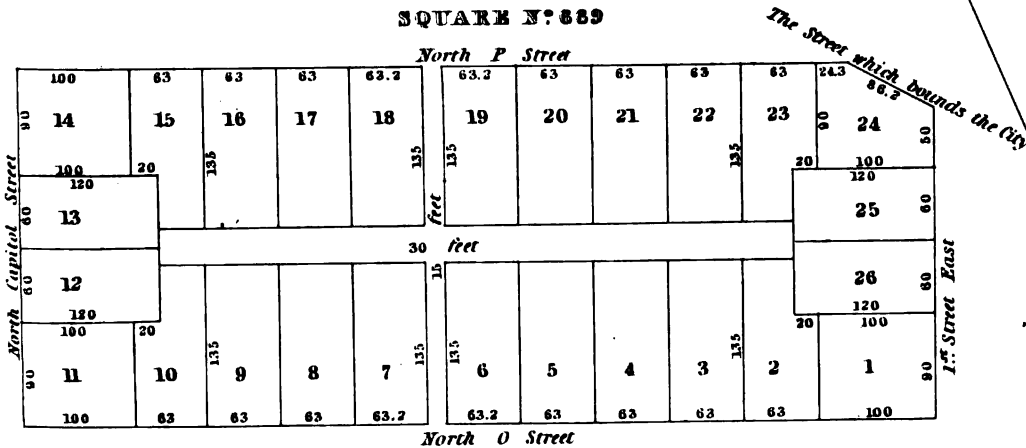



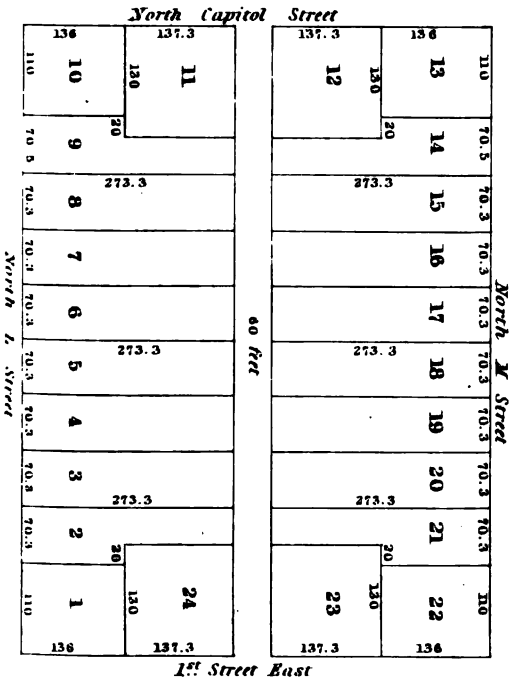
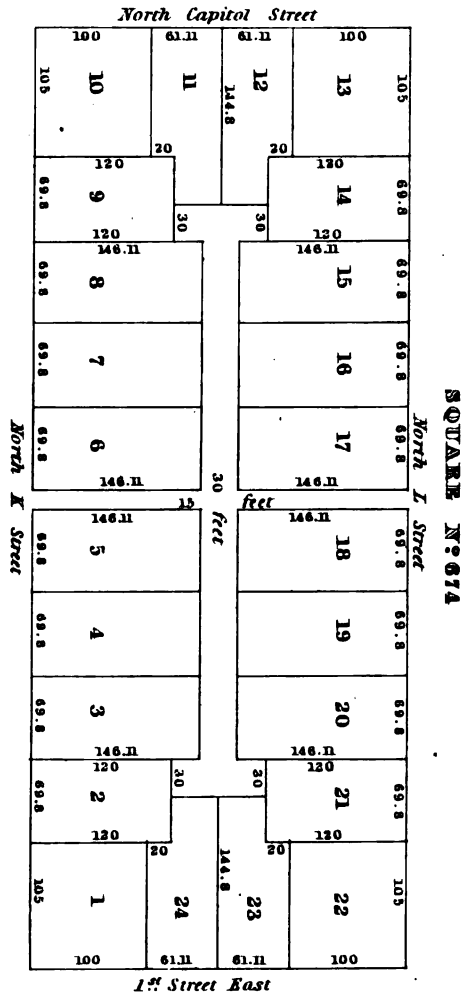
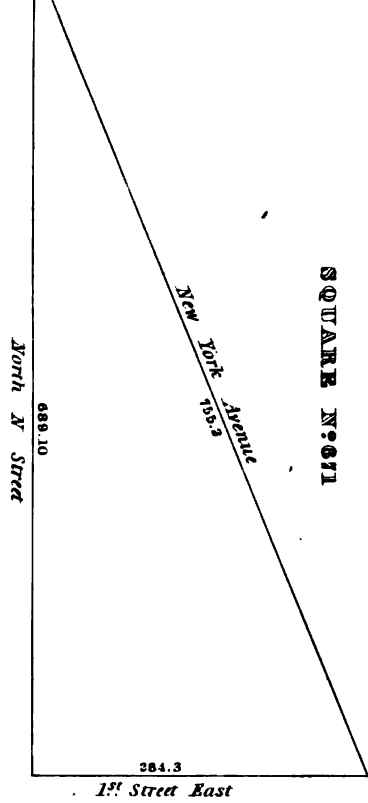
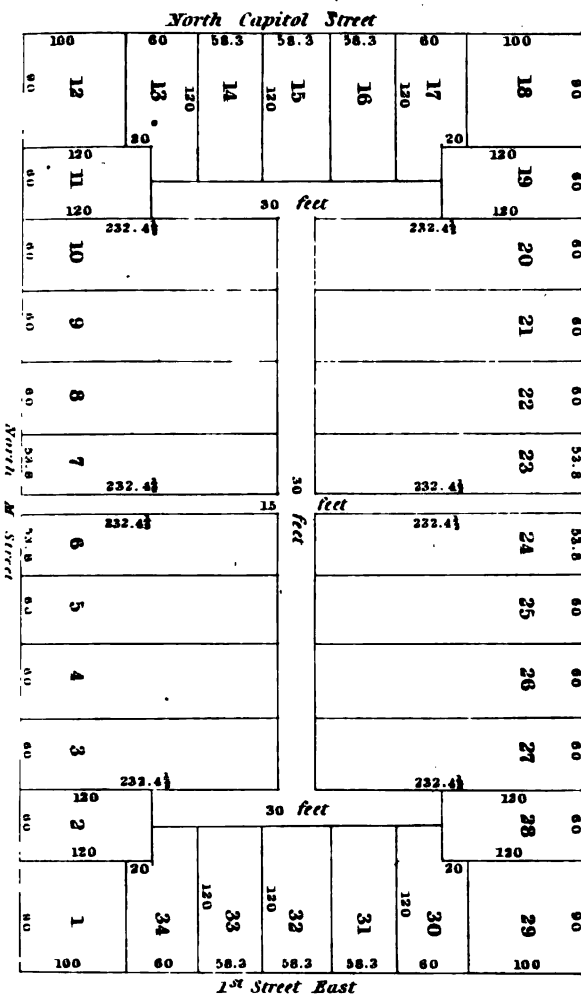

**Square N° 675**

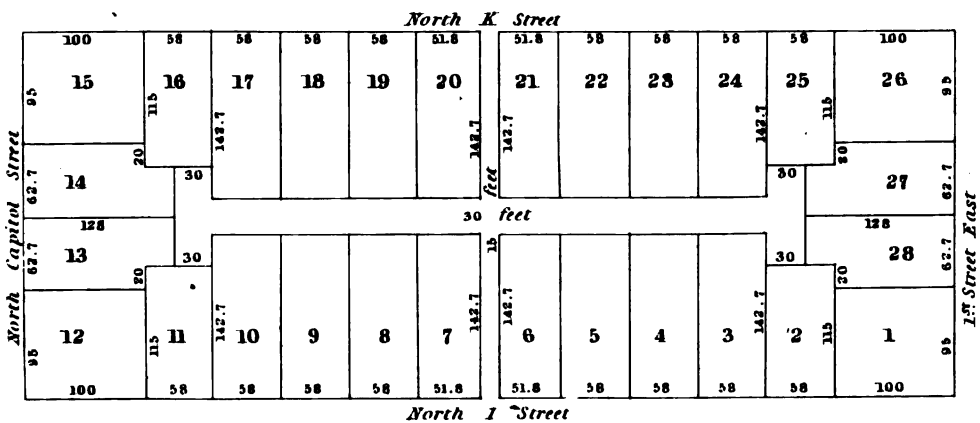





**SQUARE N:676**

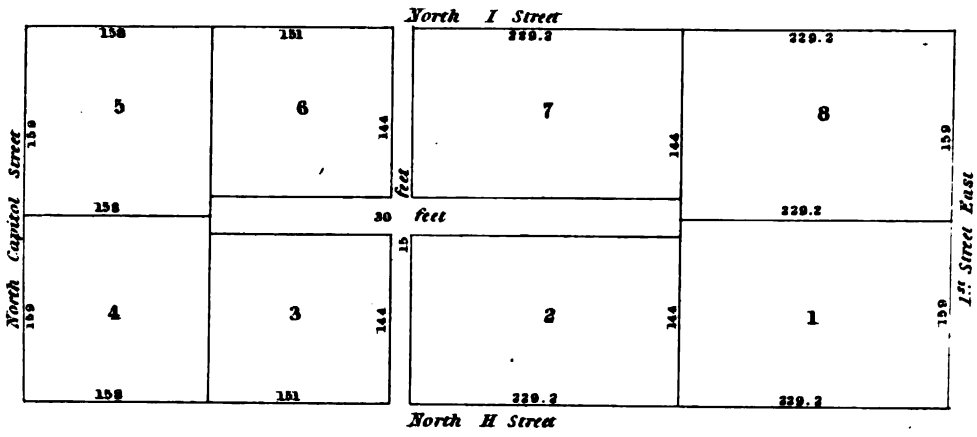

**SQUARE N:677**

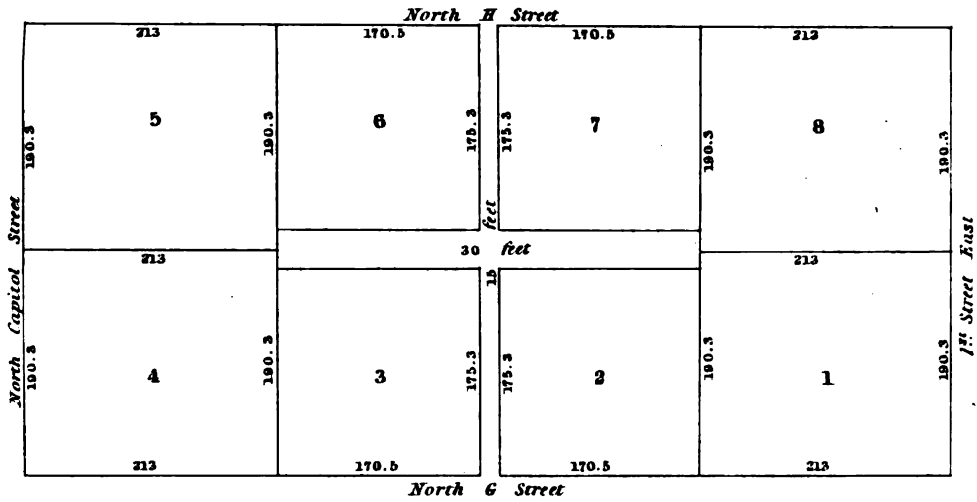

**SQUARE N:678**

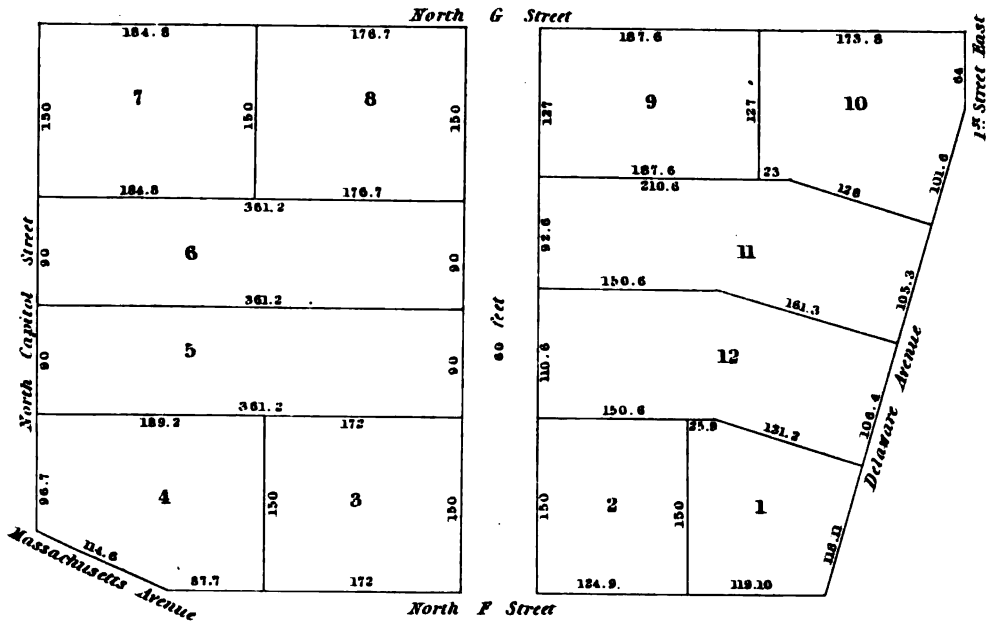

**SQUARE N:680**

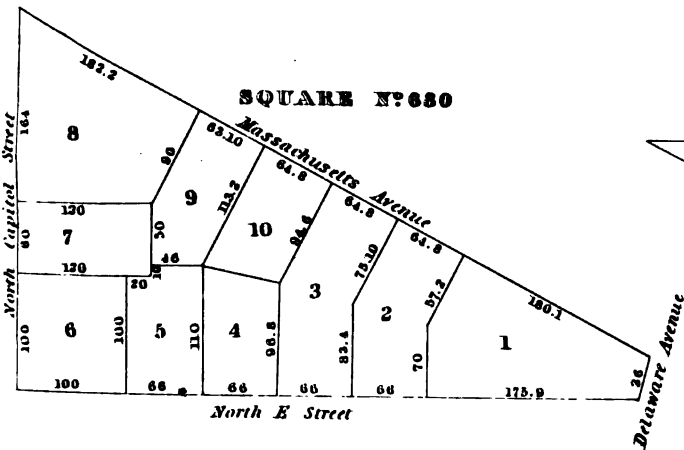

**SQUARE N:679**

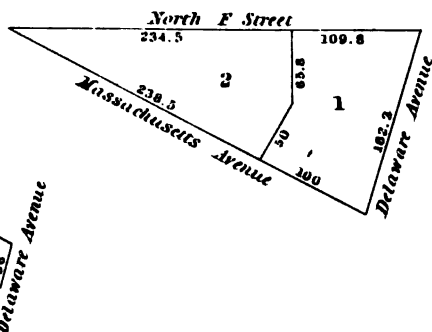



SQUARE N:681

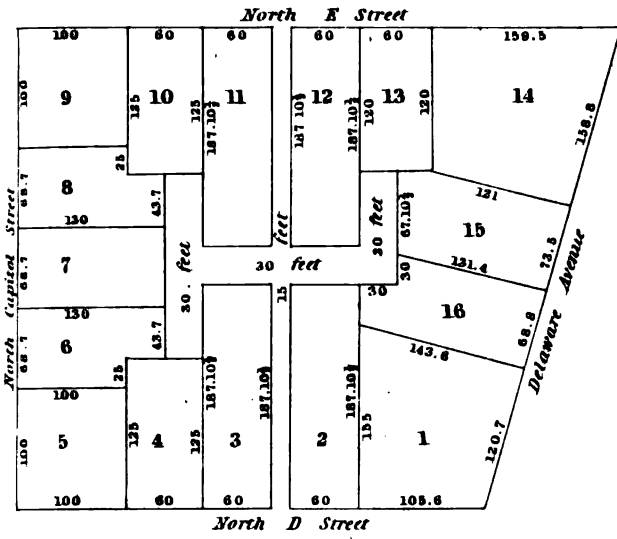

SQUARE N:682

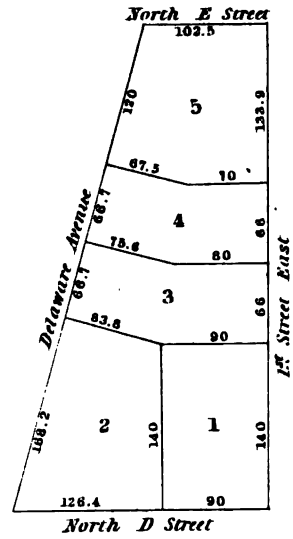

SQUARE N:683

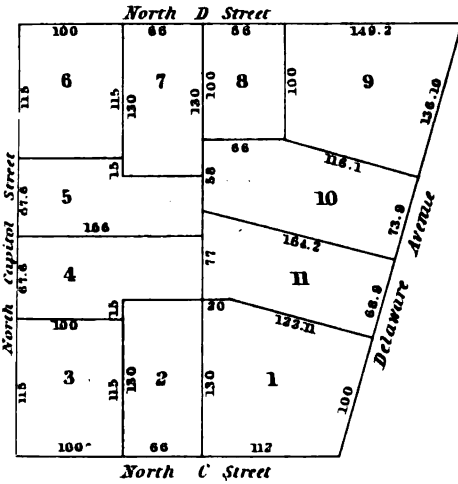

SQUARE N:684

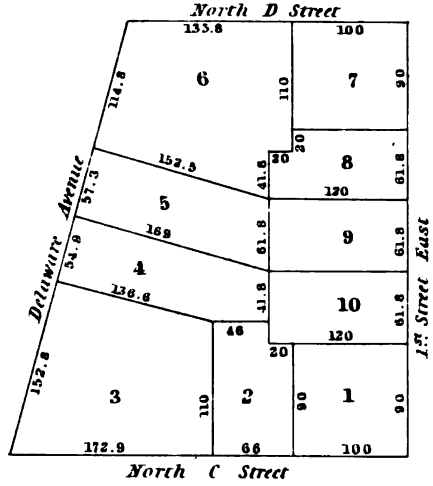

SQUARE N:685

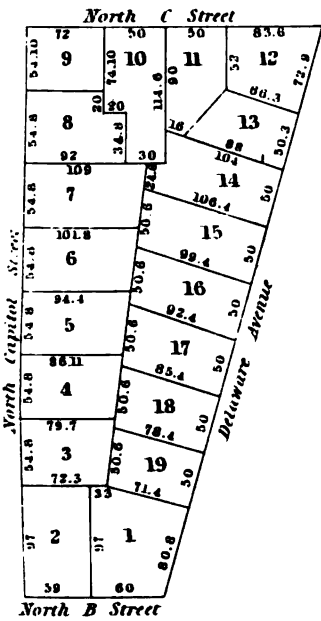

SQUARE N:686

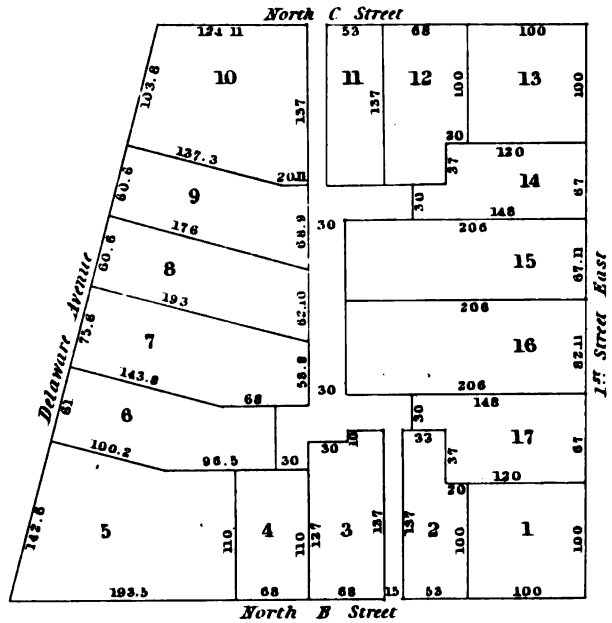

SQUARE N:687

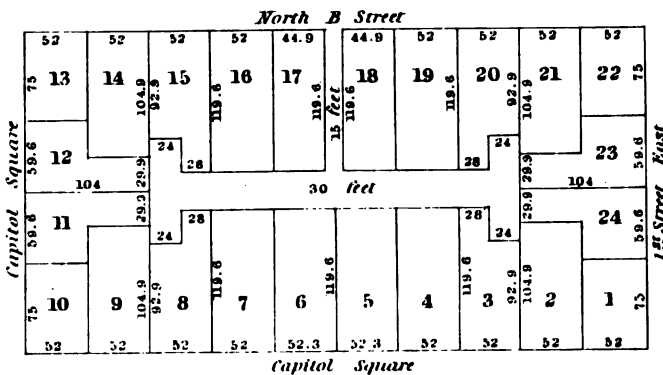



SQUARE N:688

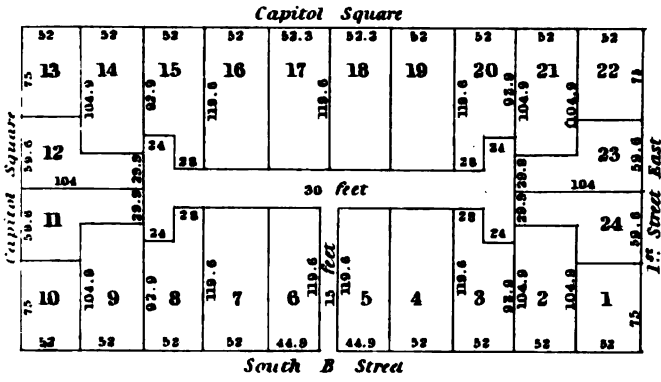

SQUARE N:689

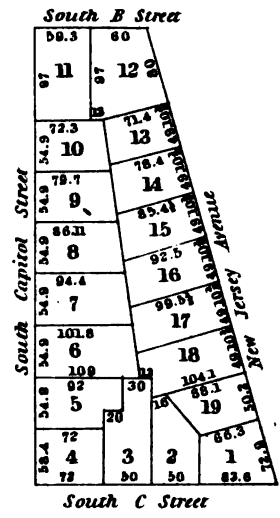

SQUARE N:690

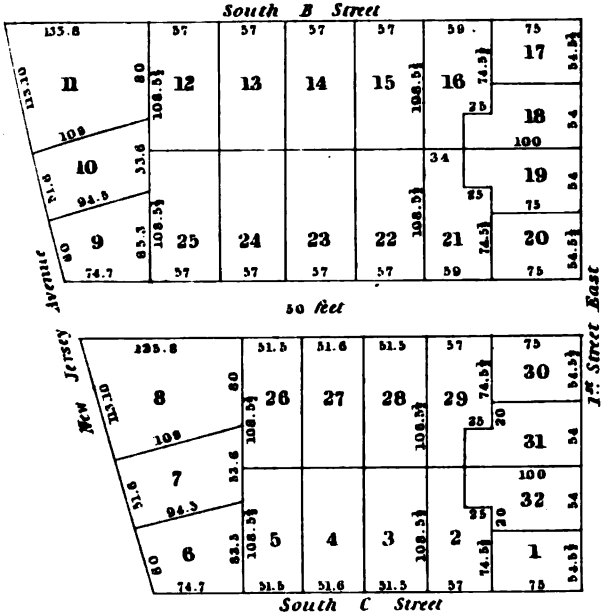

SQUARE N:691

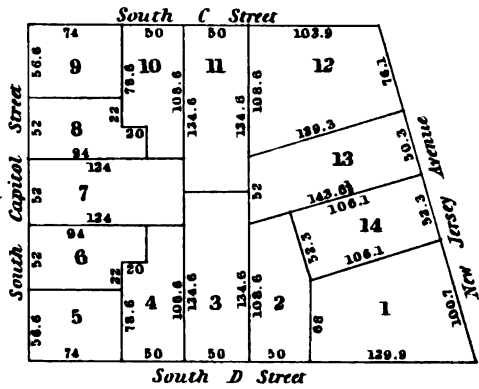

SQUARE N:692

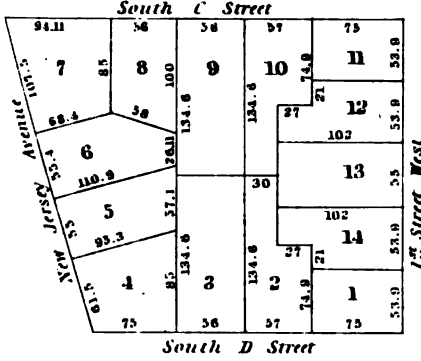

SQUARE N:693

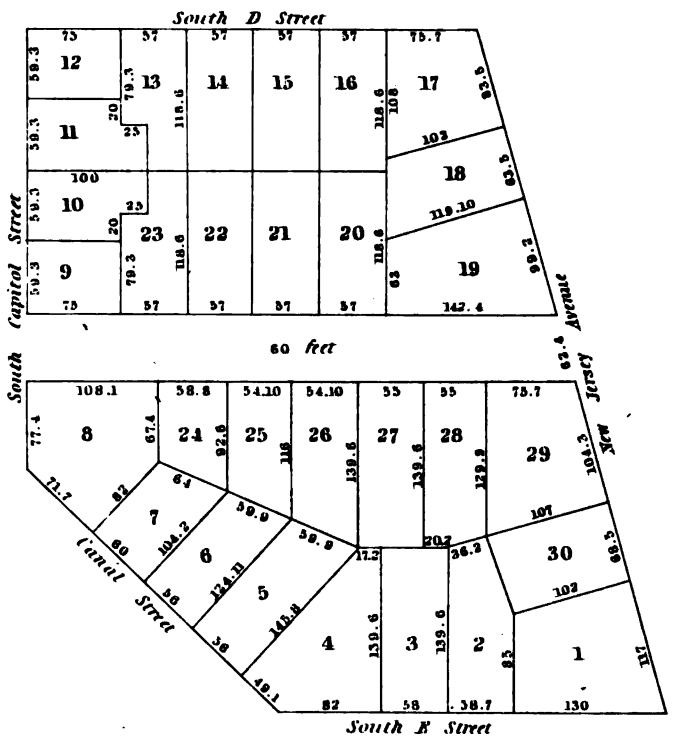

SQUARE N:696

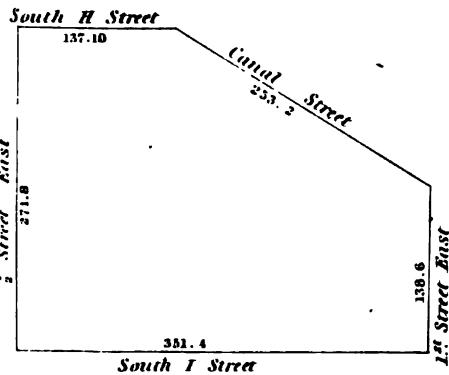

SQUARE N.W. OF N:696

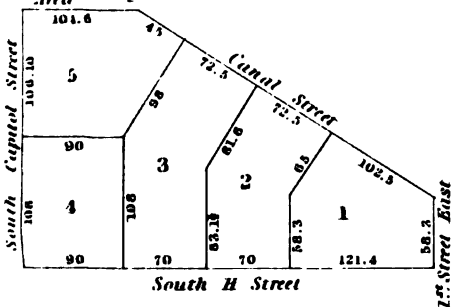

SQUARE N:694

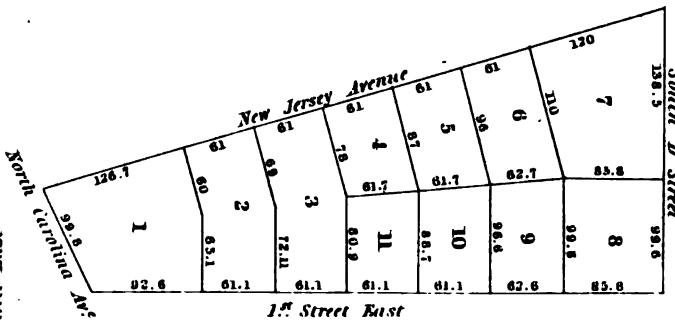



SQUARE N:696

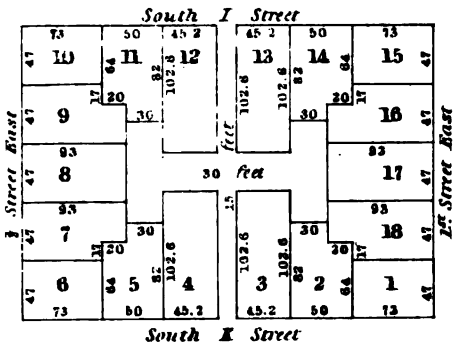

SQUARE W. OF N:696

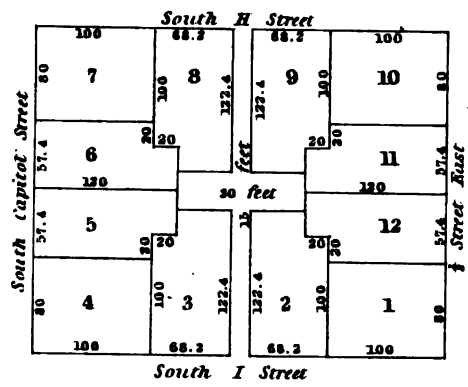

SQUARE N:697

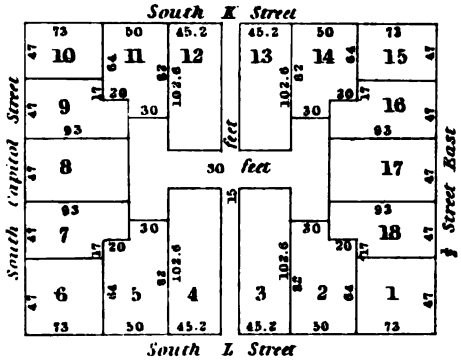

SQUARE N. OF N:697

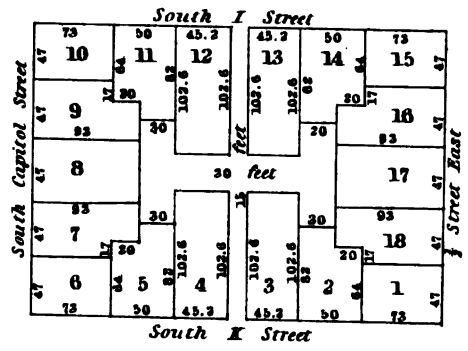

SQUARE N:698

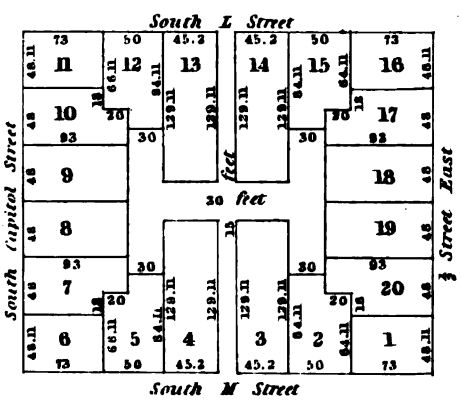

SQUARE N:699

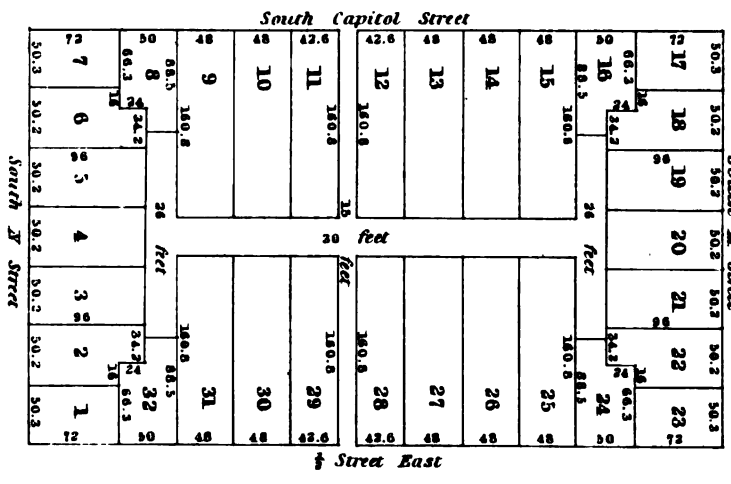
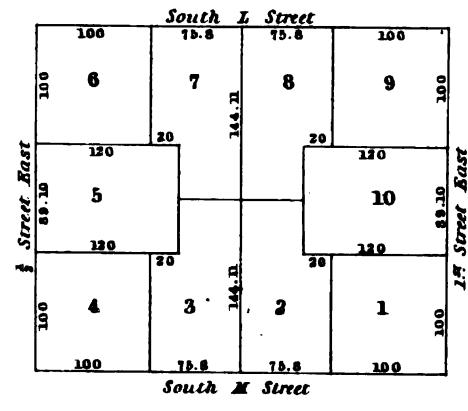

SQUARE N:700

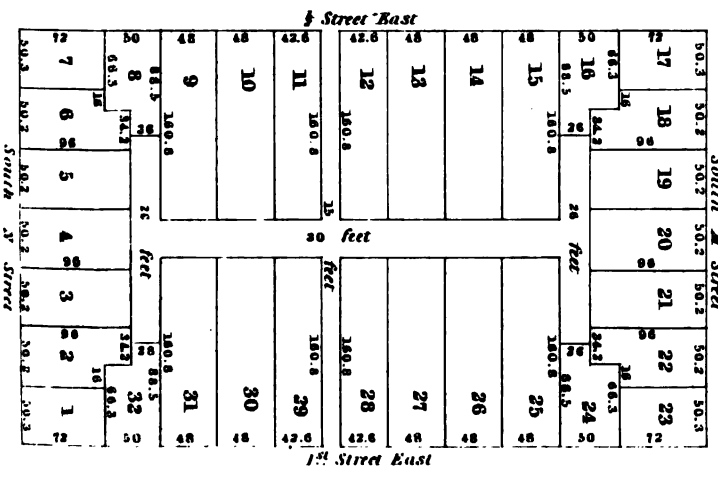

SQUARE N:701

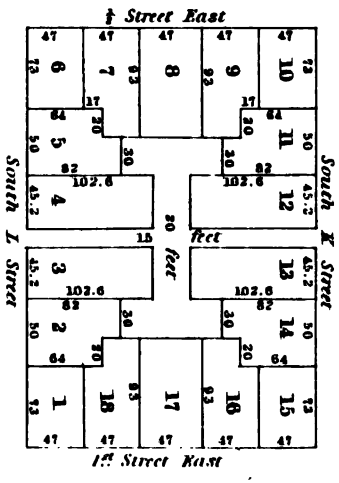

SQUARE N. OF N:699





**SQUARE N°702**

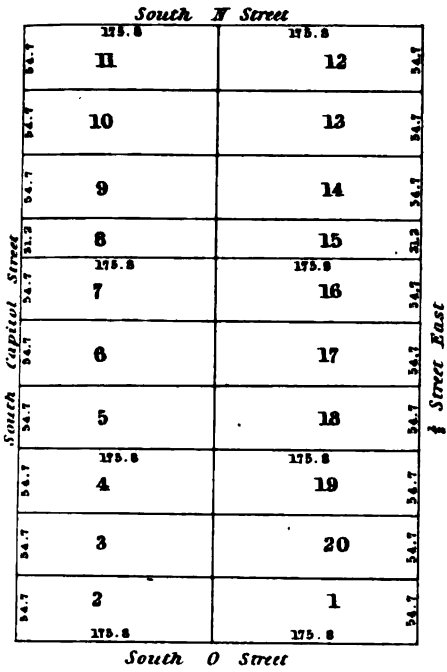

**SQUARE N°703**

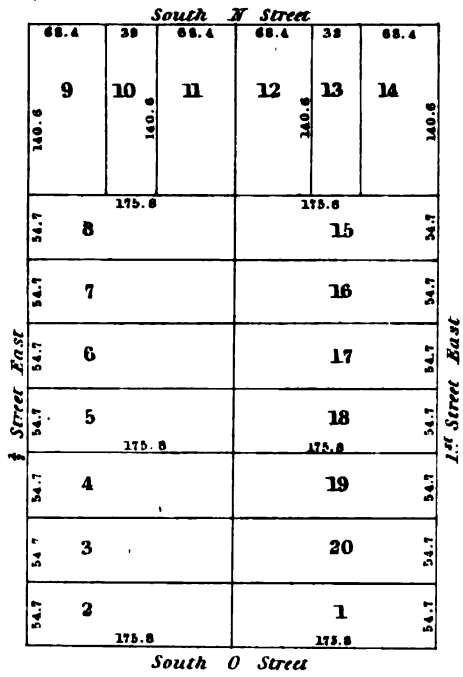

**SQUARE N°704**

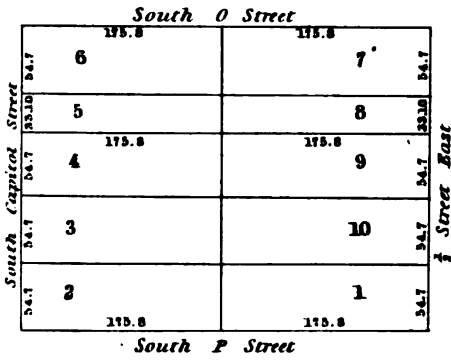

**SQUARE N°705**

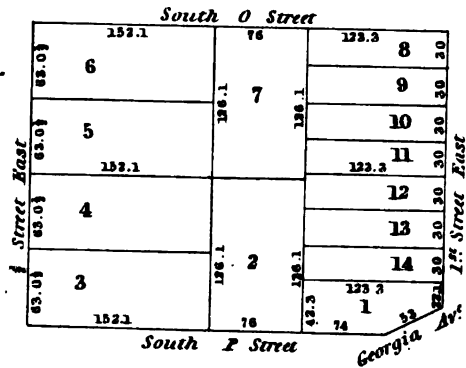

**SQUARE N°706**

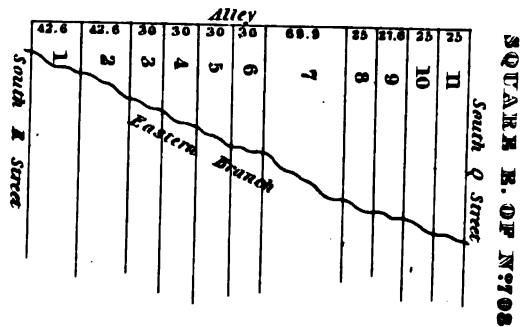
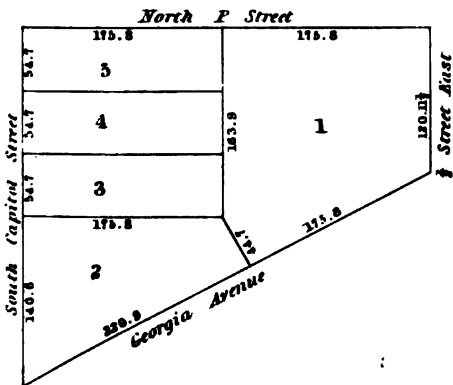

**SQUARE N°707**

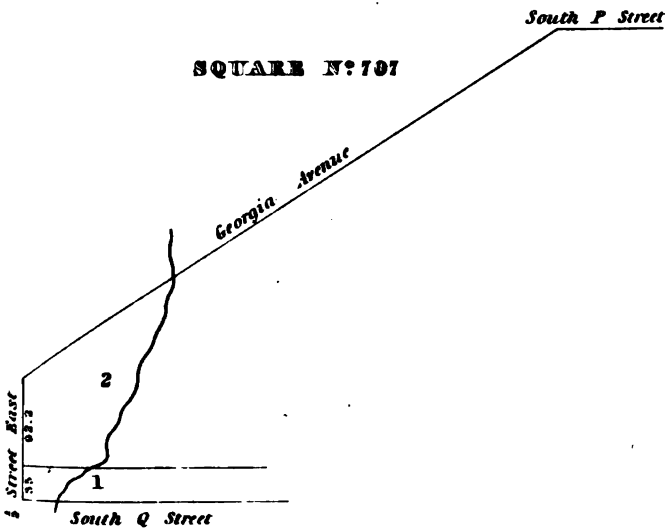

**SQUARE N°708**

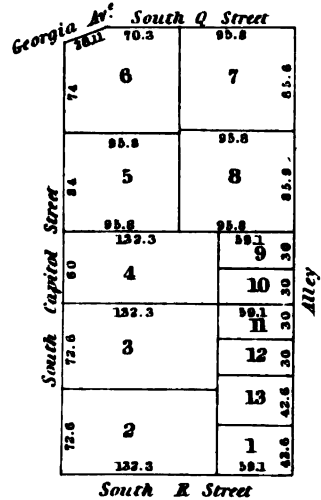



**SQUARE S. OF N:708**

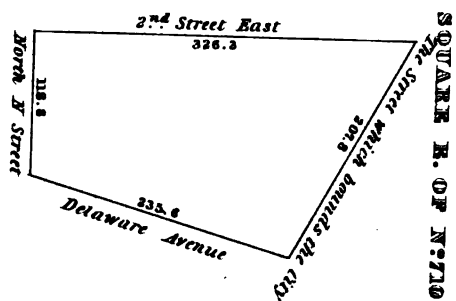
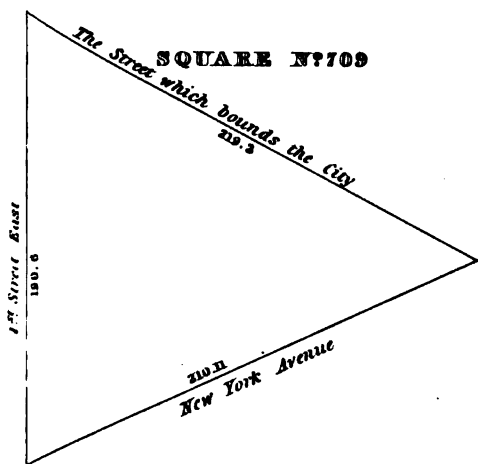
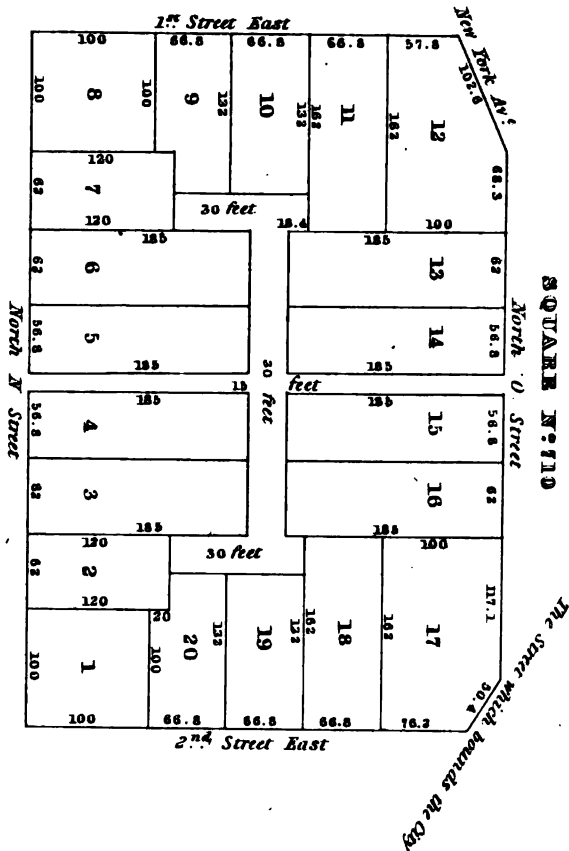
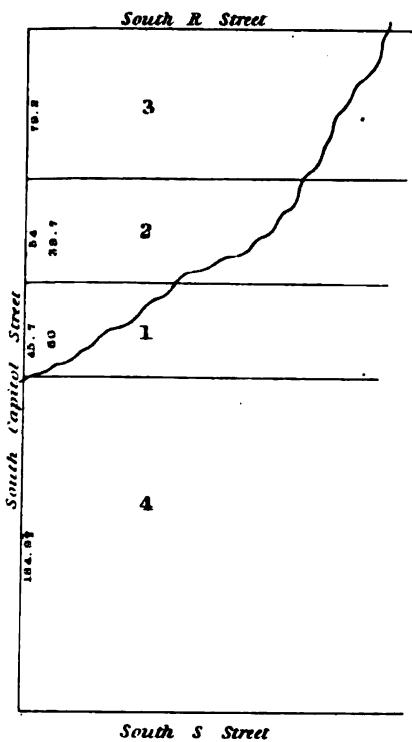

**SQUARE E. OF N:711**

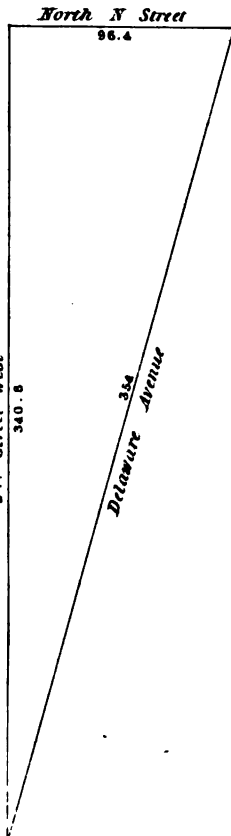

**SQUARE N:711**

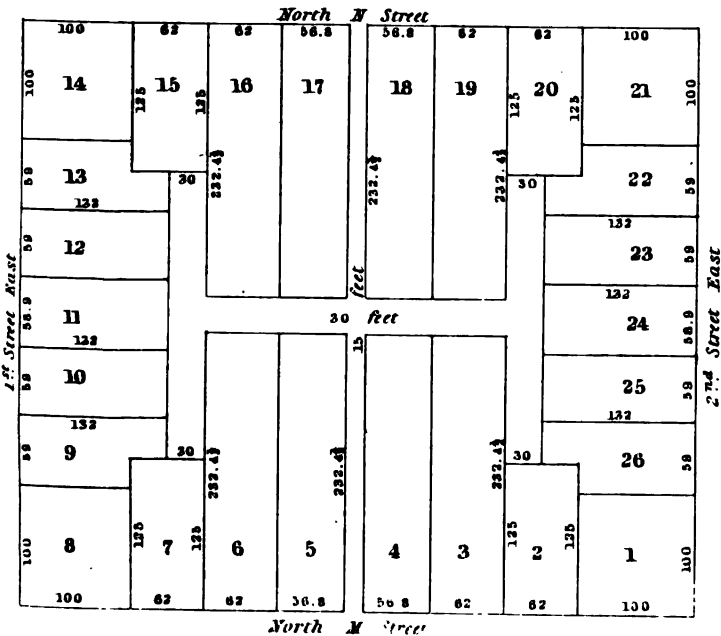

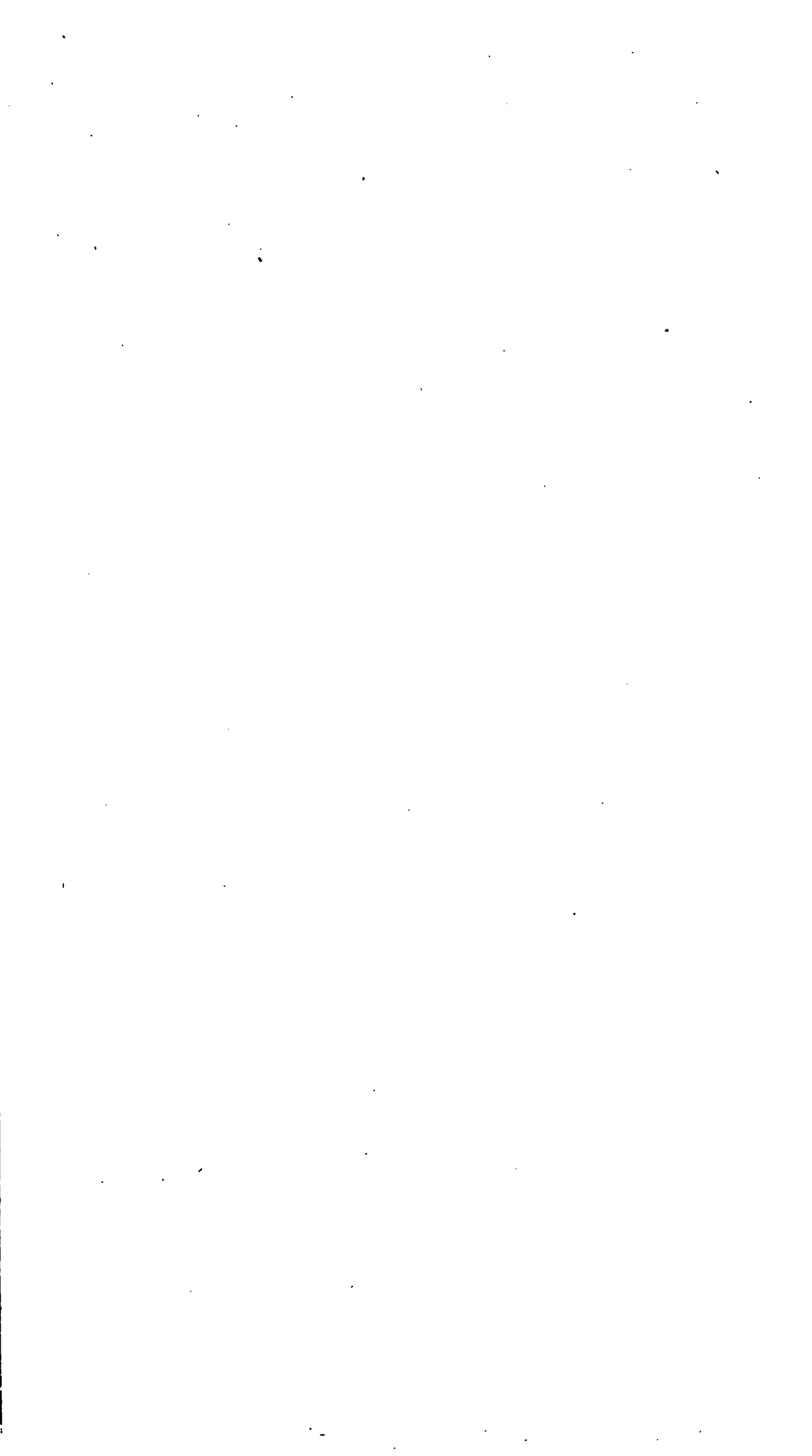

SQUARE N:712

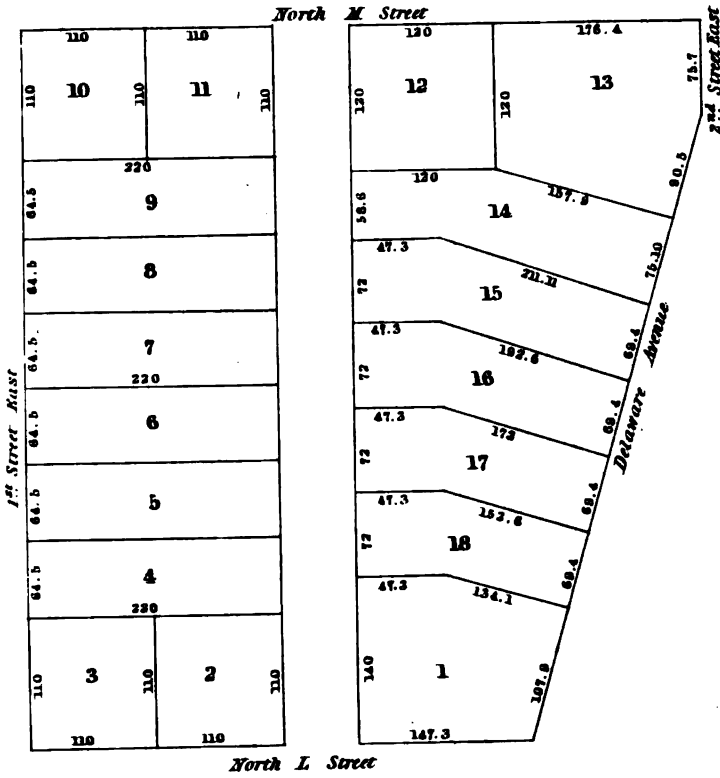

SQUARE N:714

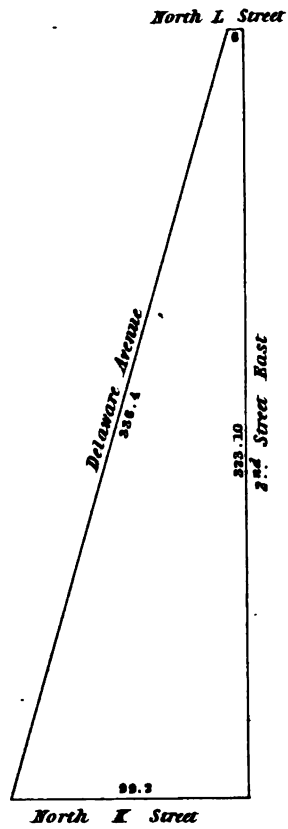

SQUARE N:713

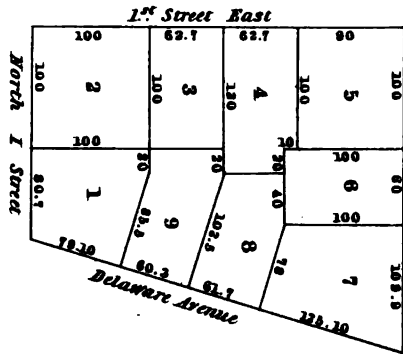
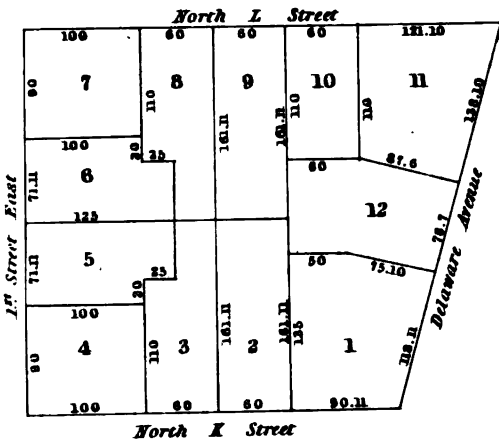

SQUARE N:715

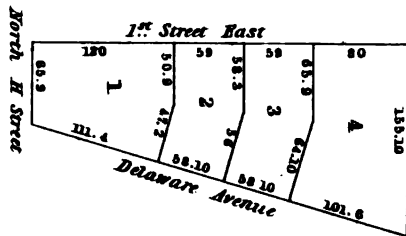

SQUARE N:717



SQUARE N:716

SQUARE N:718

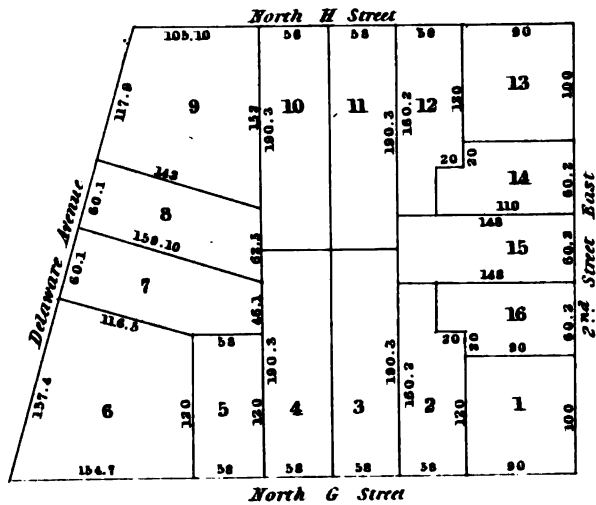
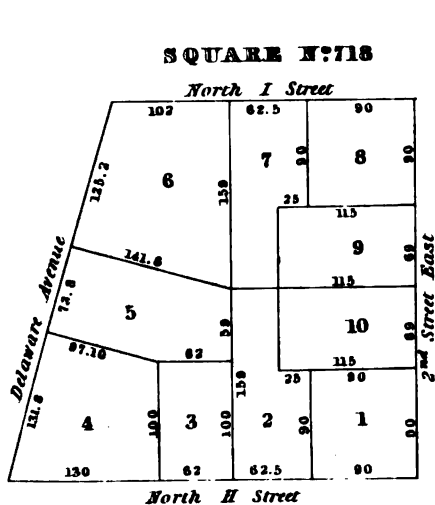

SQUARE N:719

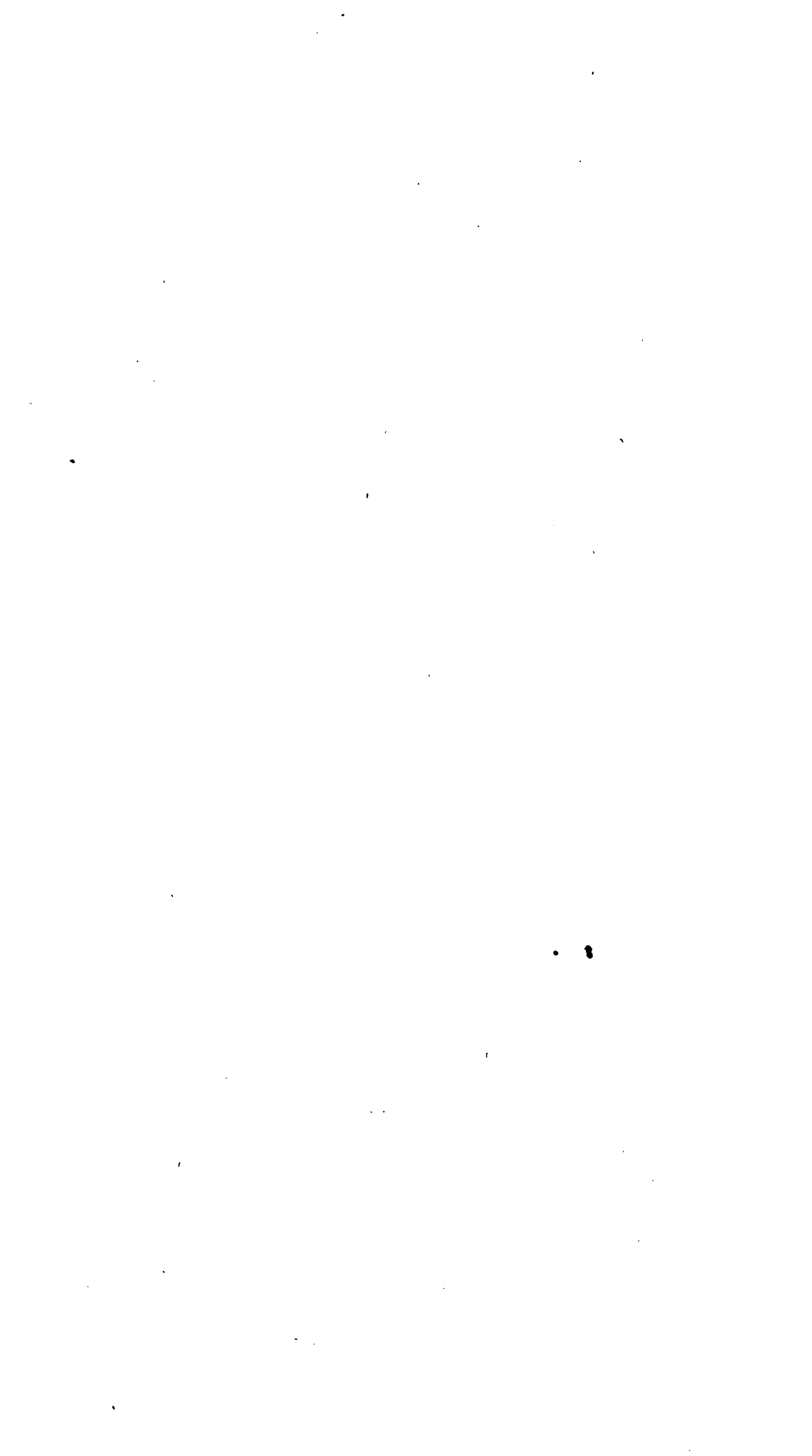

SQUARE N:120

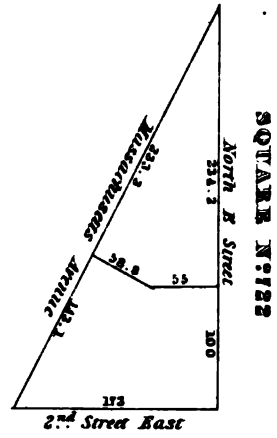
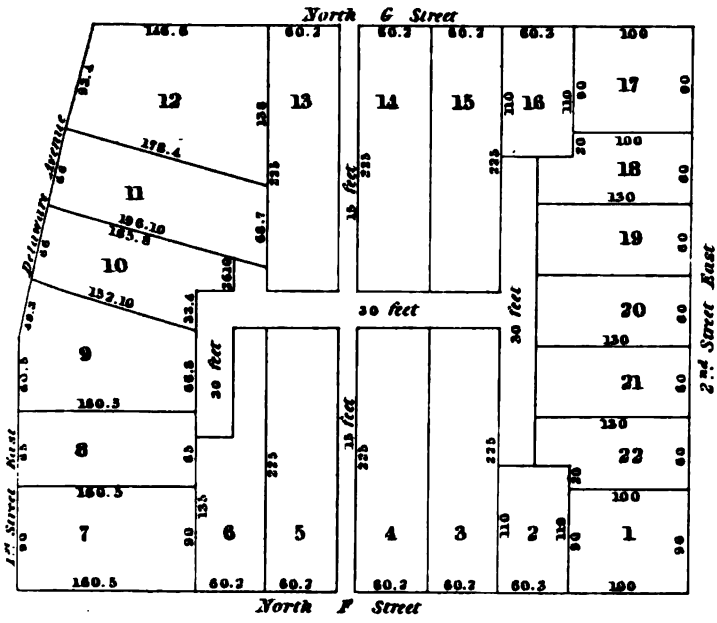

SQUARE N:121

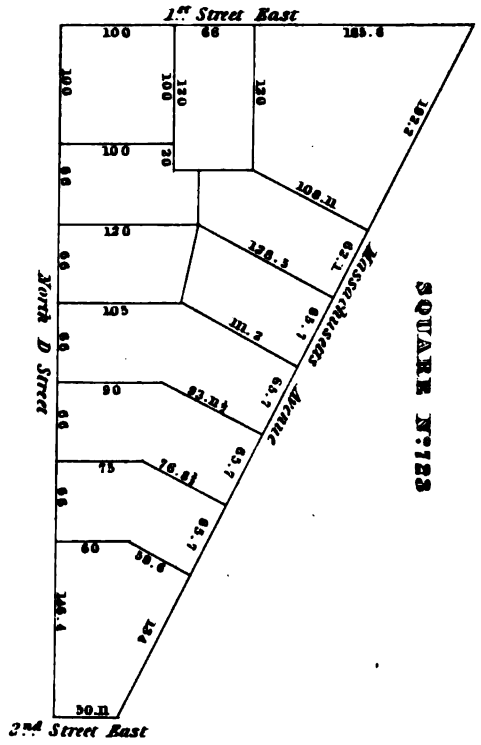
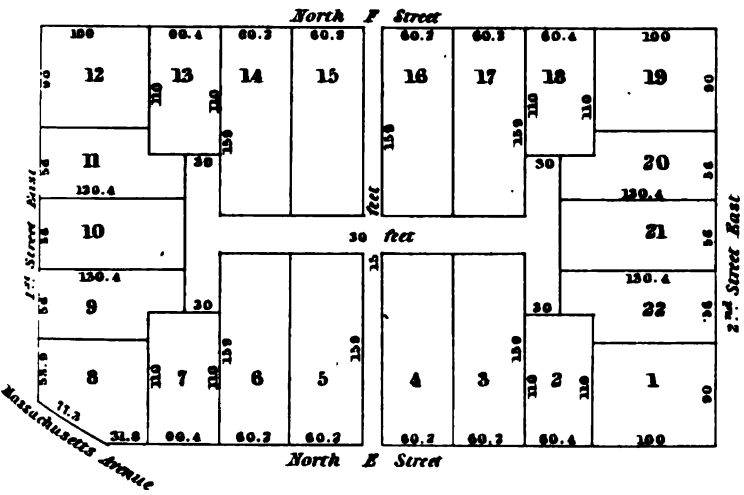

SQUARE N:124

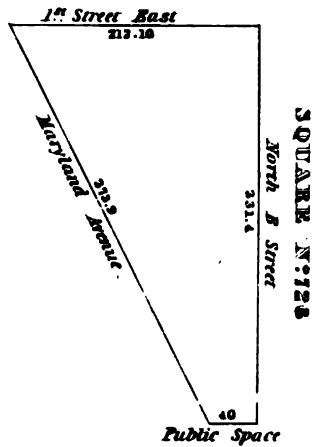
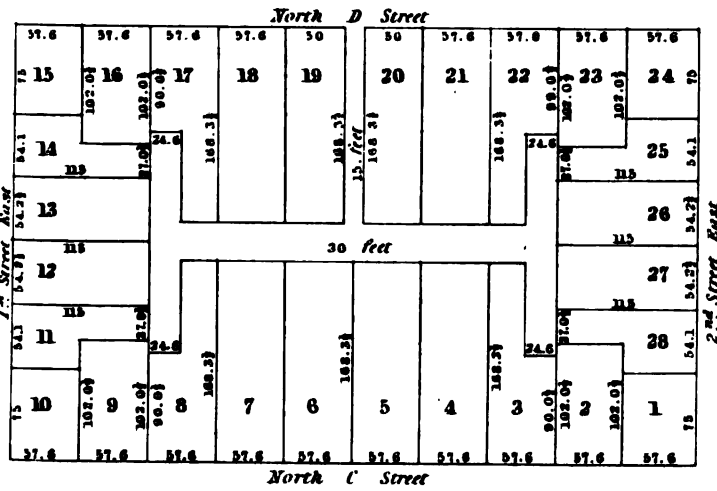

SQUARE N:126

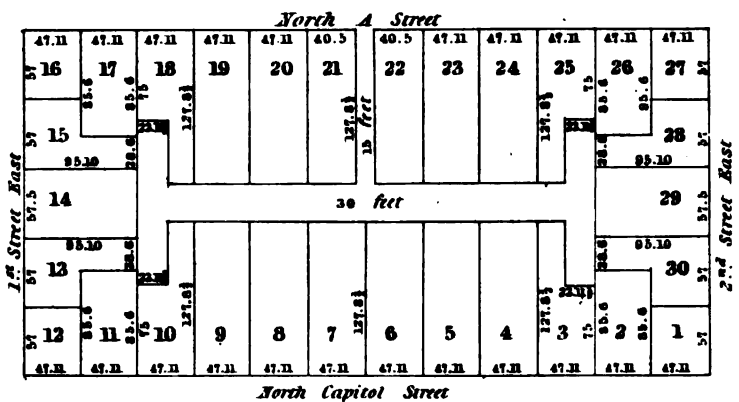

SQUARE N:127

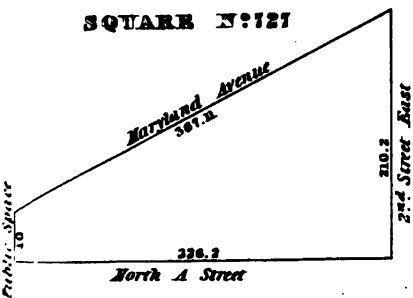





SQUARE N:125

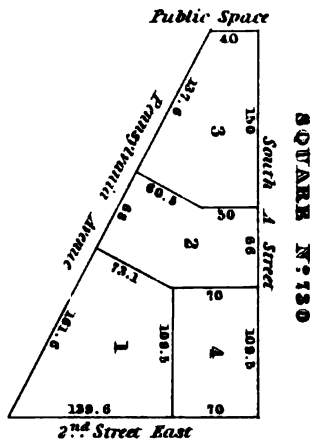
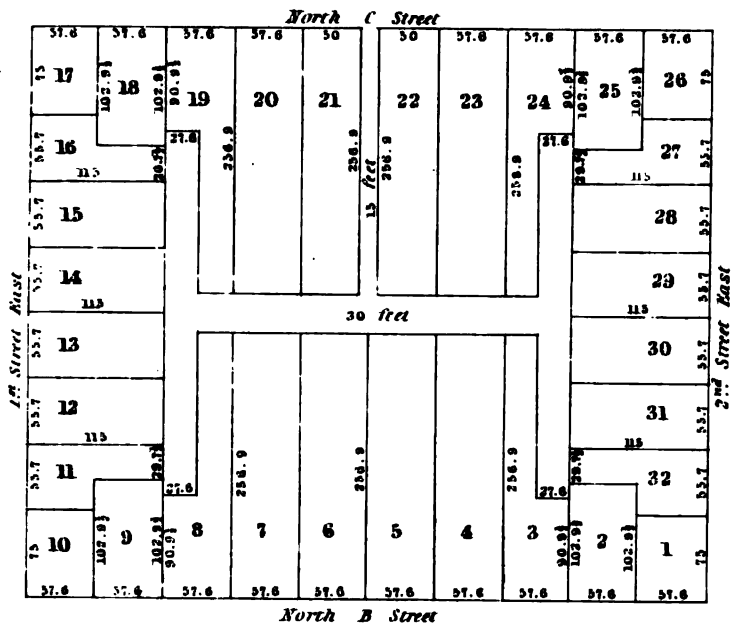

SQUARE N:129

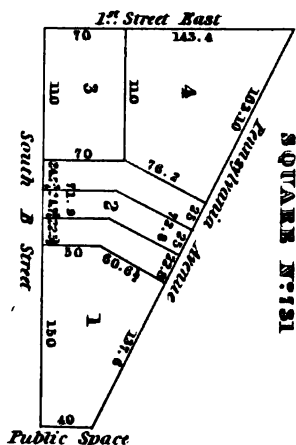
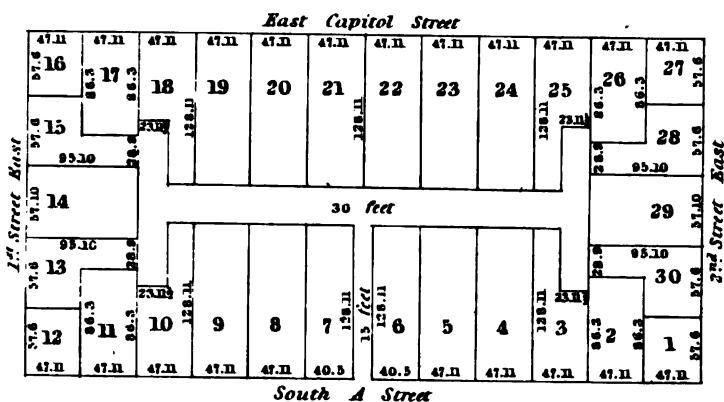

SQUARE N:132

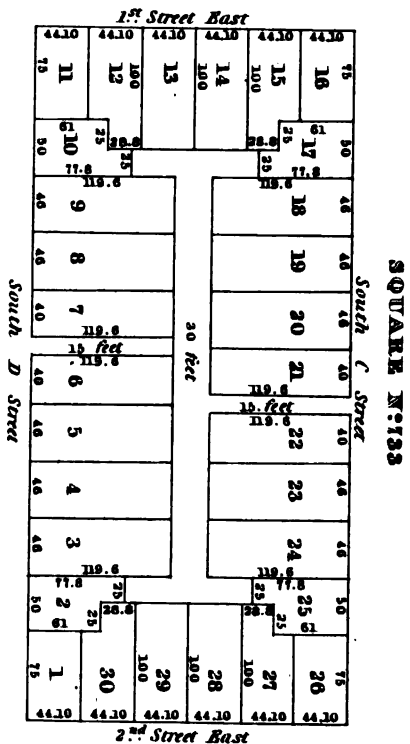
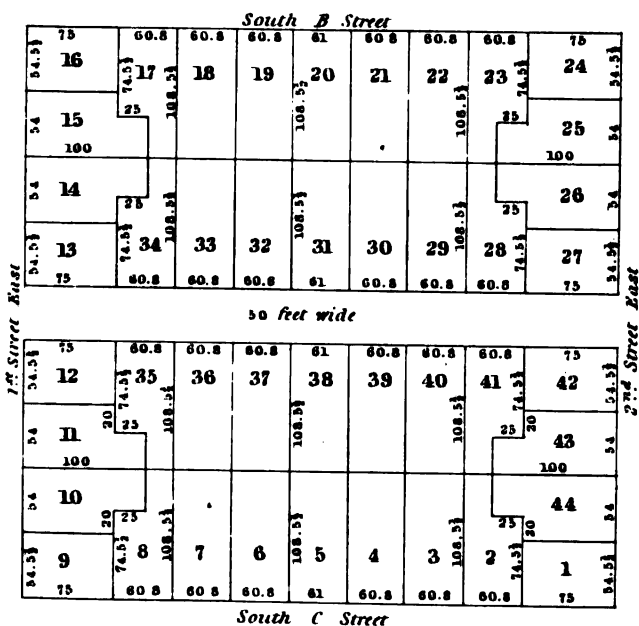

SQUARE N:135

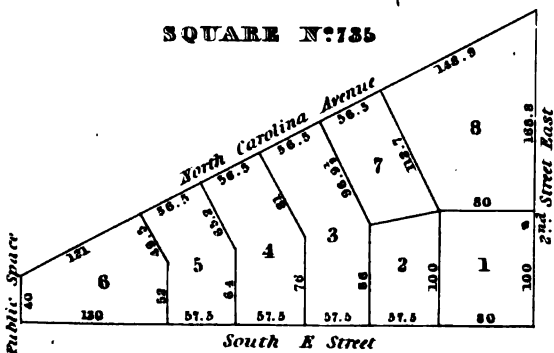



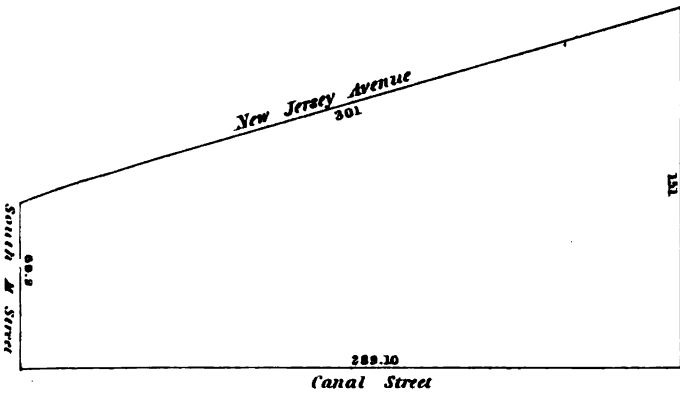

**SQUARE N. OF N:743**

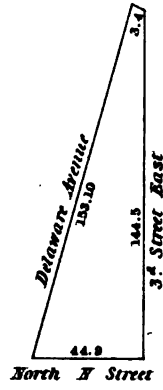

**SQUARE N:745**

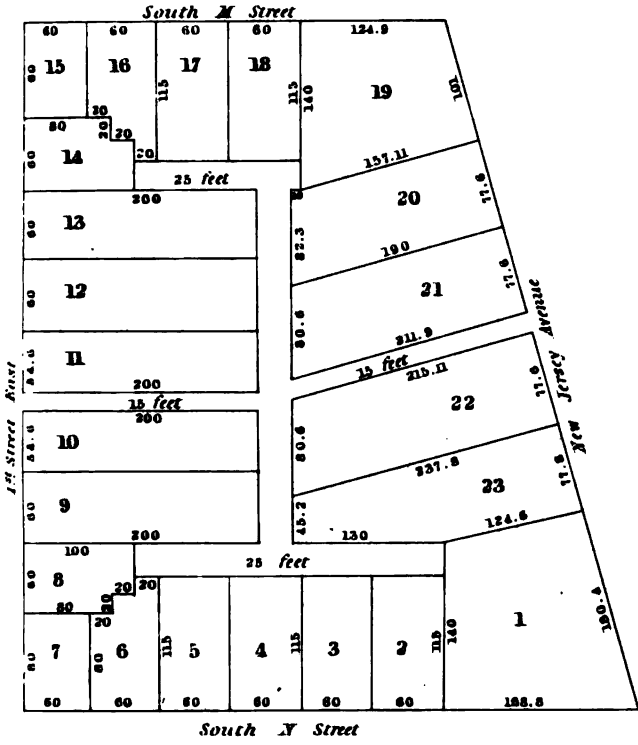

**SQUARE N. OF N:745**

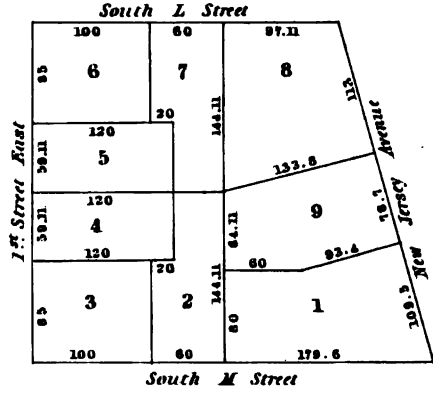

**SQUARE N:746**

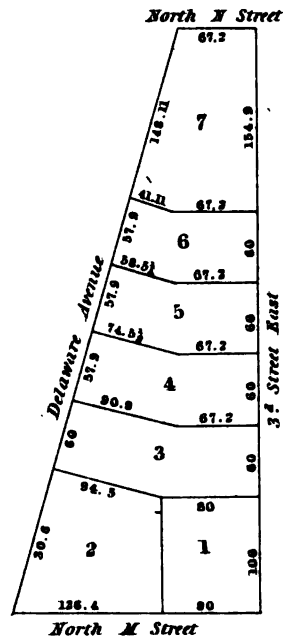

**SQUARE N:744**

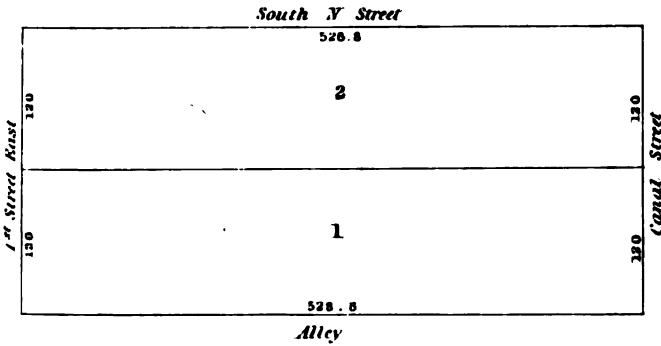

**SQUARE N:749**

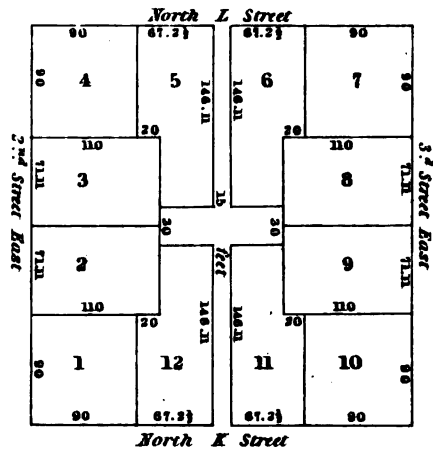

**SQUARE S. OF N:744**

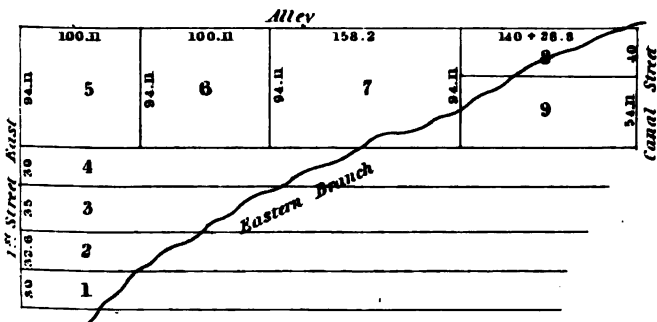



**SQUARE N°748**

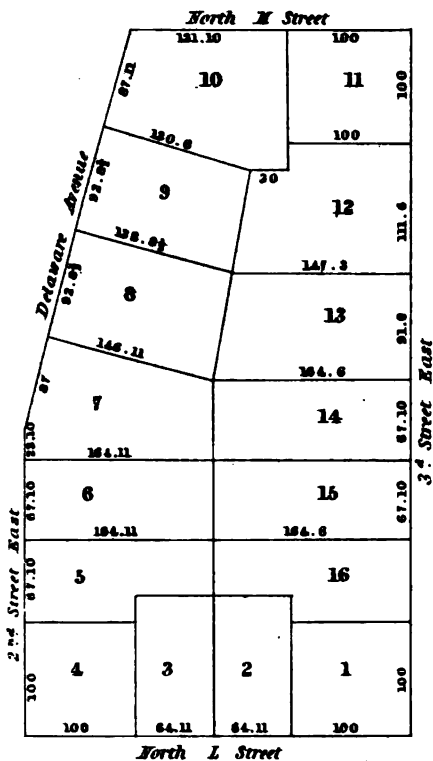

**SQUARE N°750**

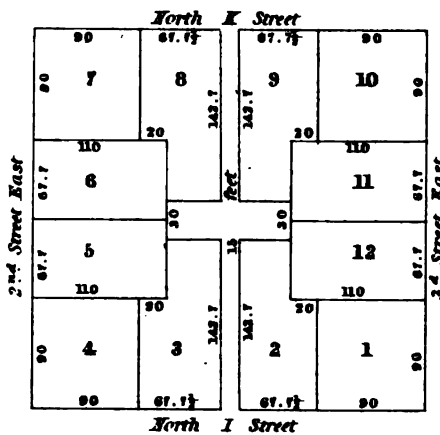

**SQUARE N°751**

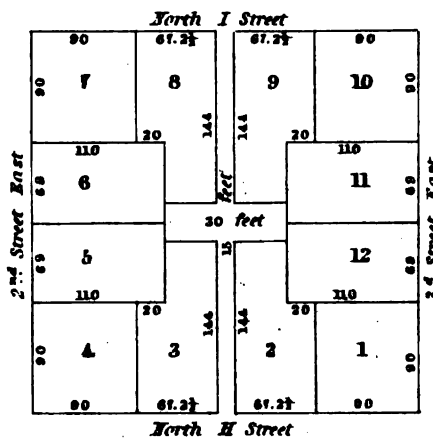

**SQUARE N°753**

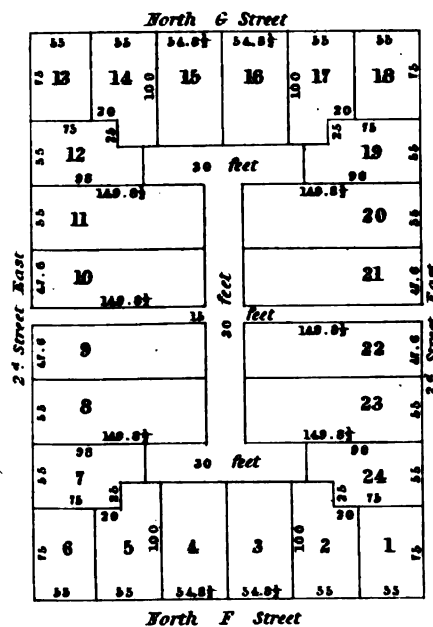

**SQUARE N°752**

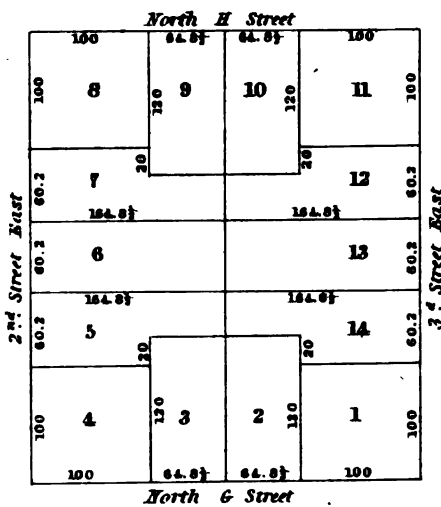

**SQUARE N°754**

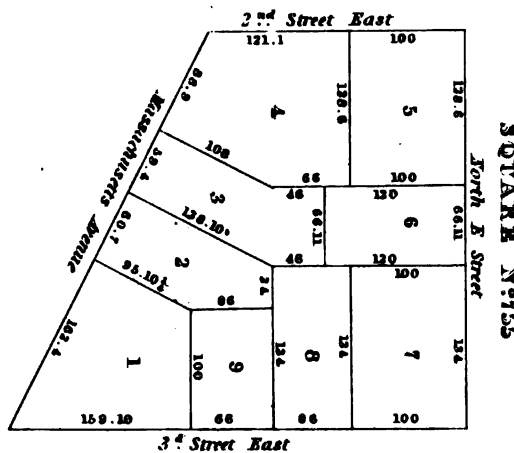
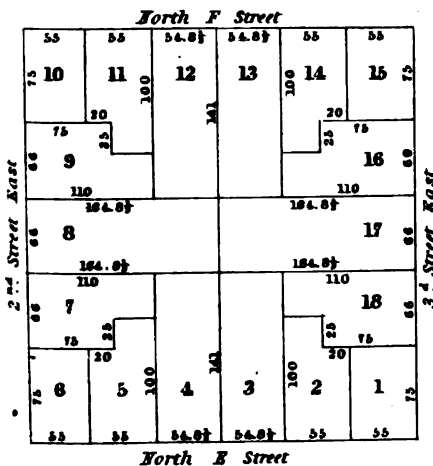



SQUARE N°765

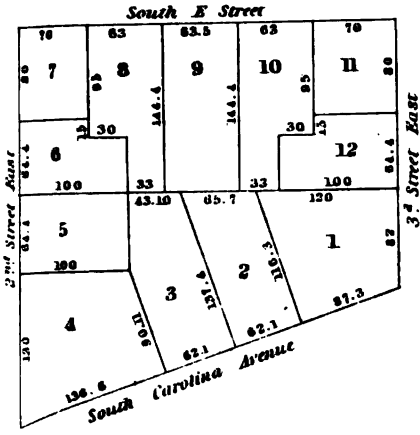

SQUARE N°764

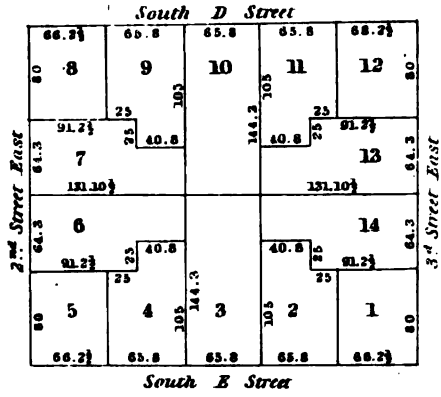

SQUARE N°768

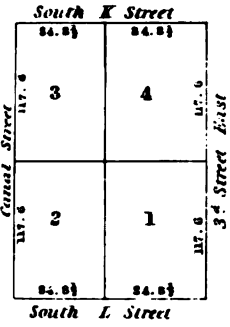

SQUARE N°767

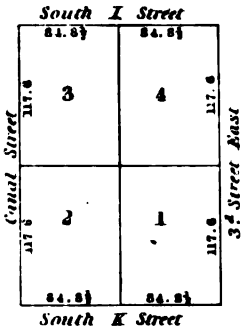

SQUARE N°766

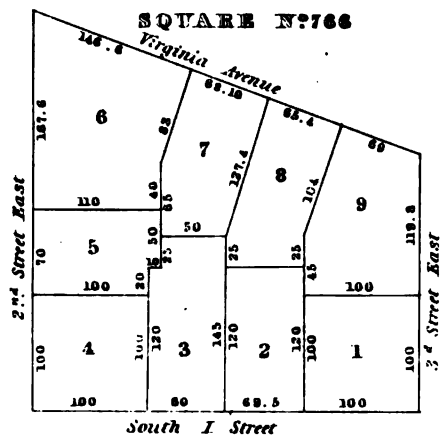

SQUARE N°769

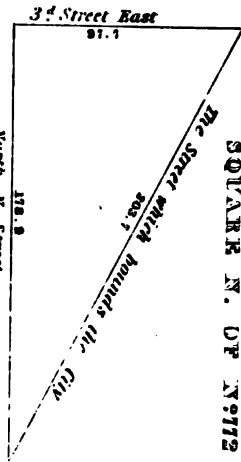
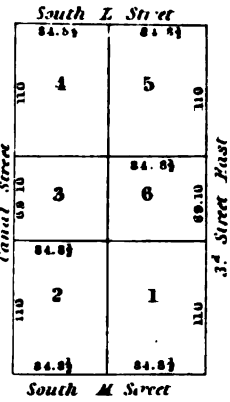

SQUARE N°771

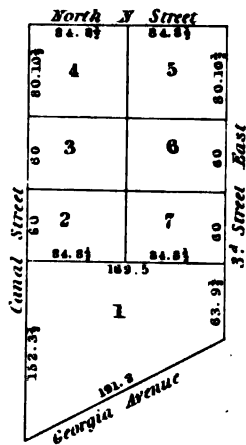

SQUARE N°770

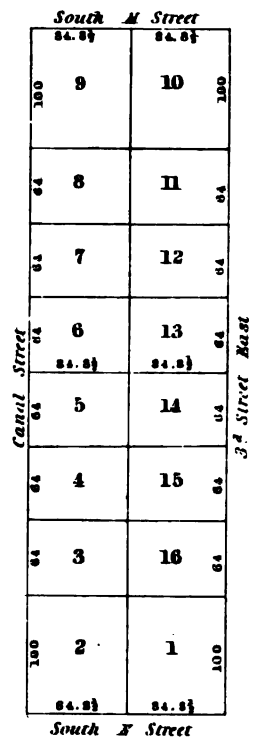

SQUARE N°773

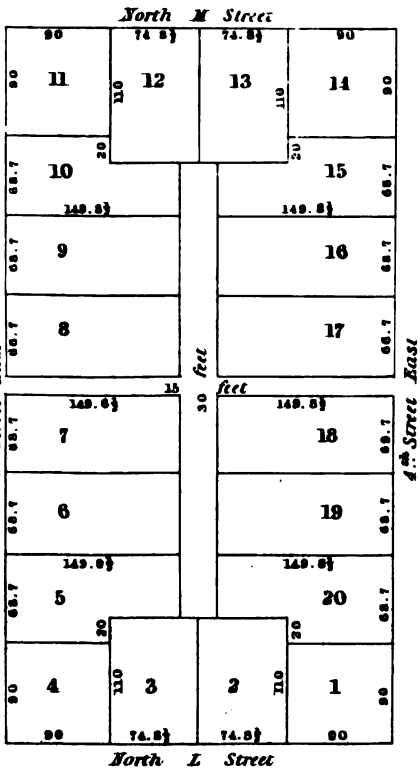

SQUARE N°772

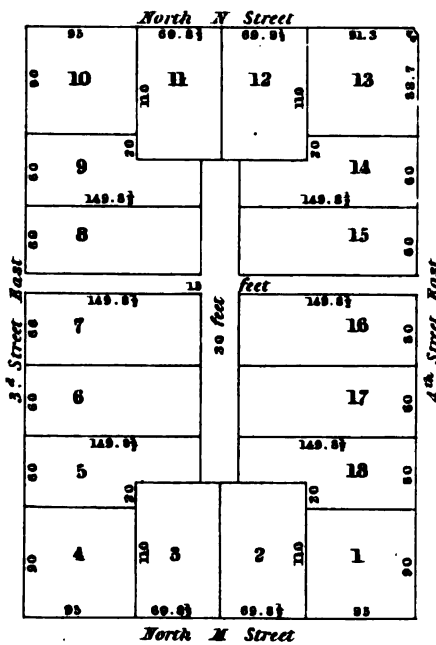





SQUARE N:774

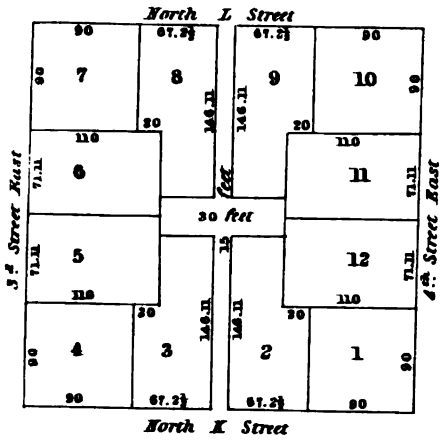

SQUARE N:775

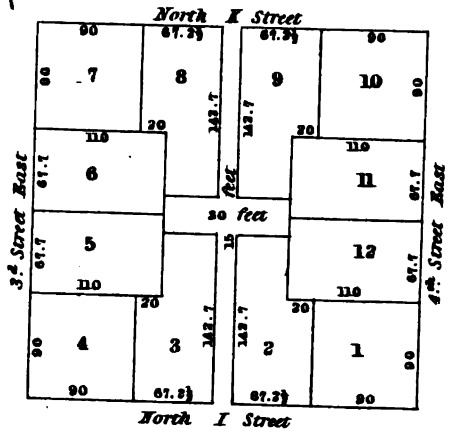

SQUARE N:776

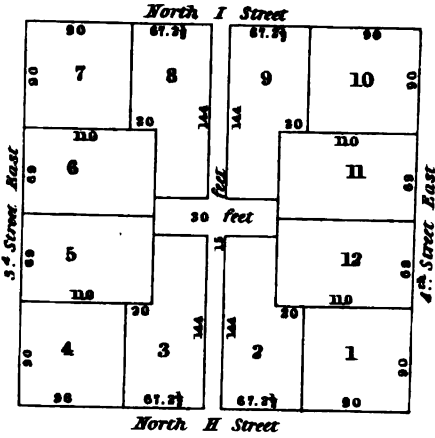

SQUARE N:777

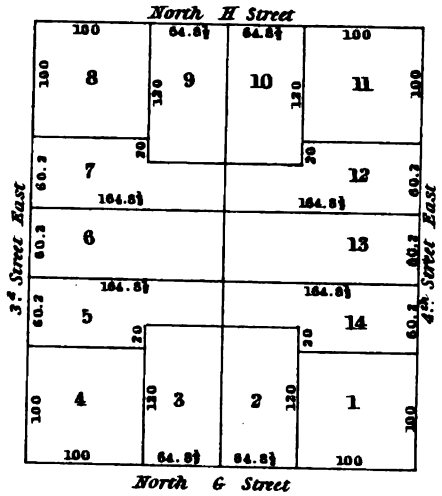

SQUARE N:778

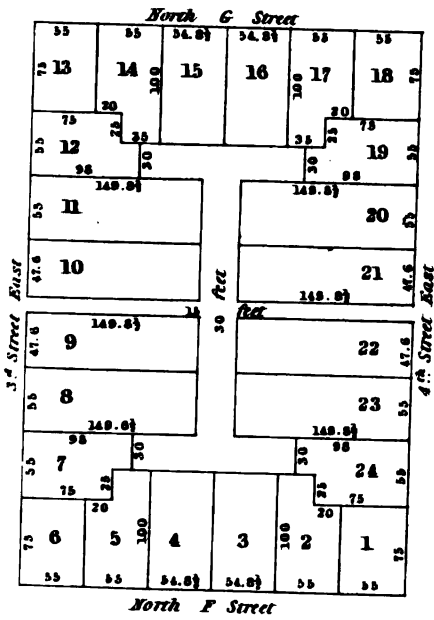

SQUARE N:779

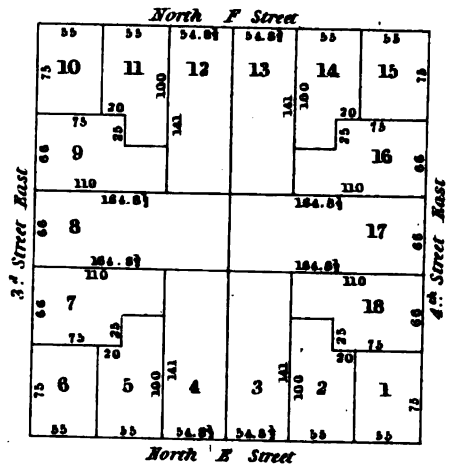

SQUARE N:780

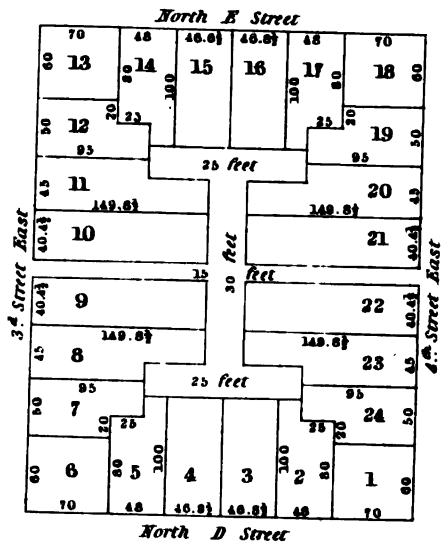

SQUARE N:781

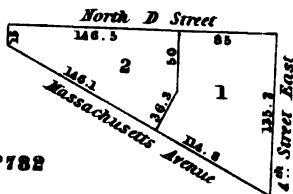

SQUARE N:782

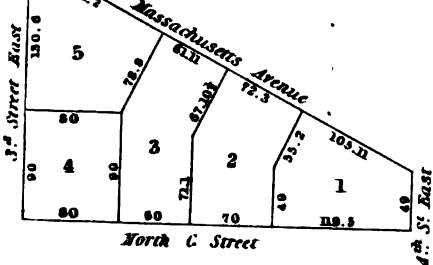



**SQUARE N°784**

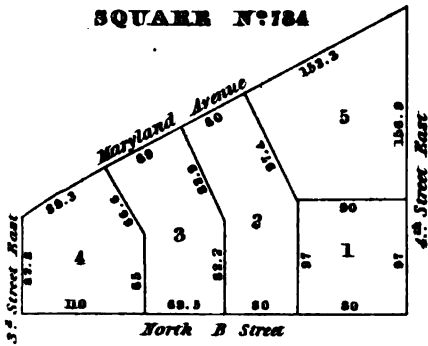

**SQUARE N°783**

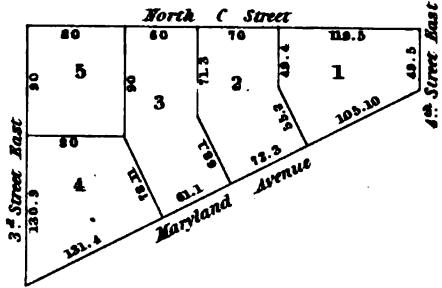

**SQUARE N°785**

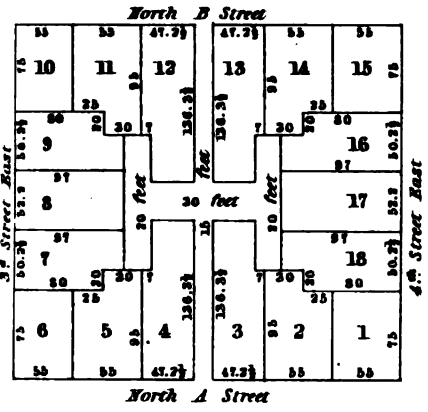

**SQUARE N°786**

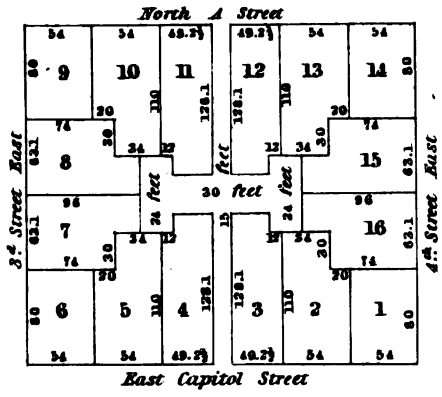

**SQUARE N°787**

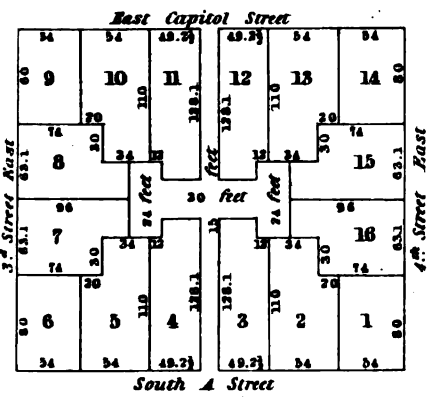

**SQUARE N°788**

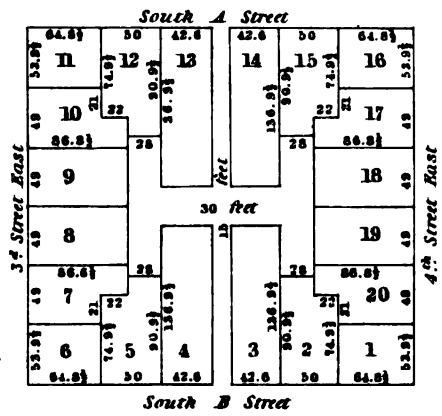

**SQUARE N°789**

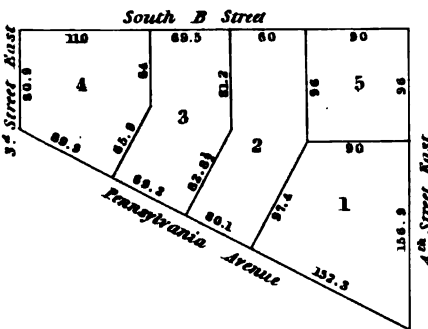

**SQUARE N°790**

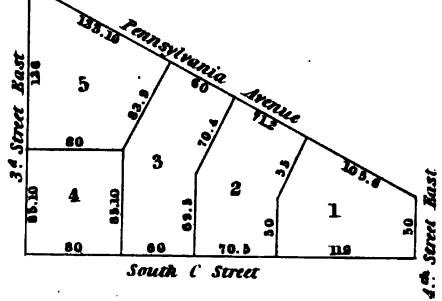

**SQUARE N°791**

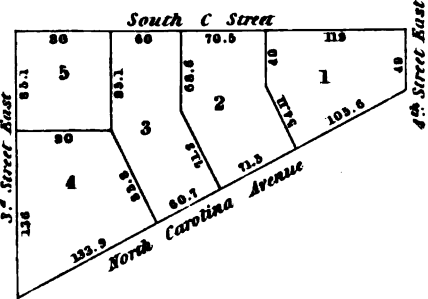

**SQUARE N°792**

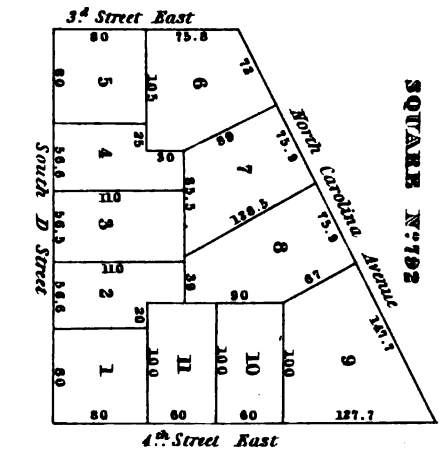



SQUARE N:793

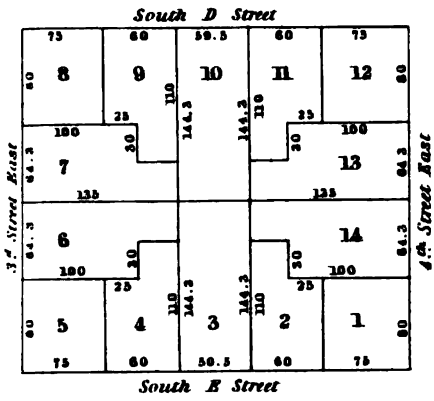

SQUARE N:794

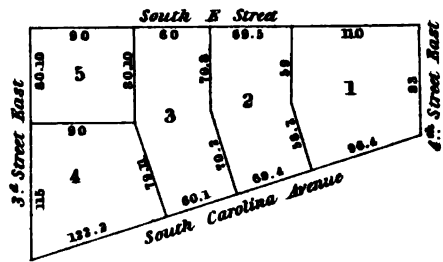

SQUARE N:795

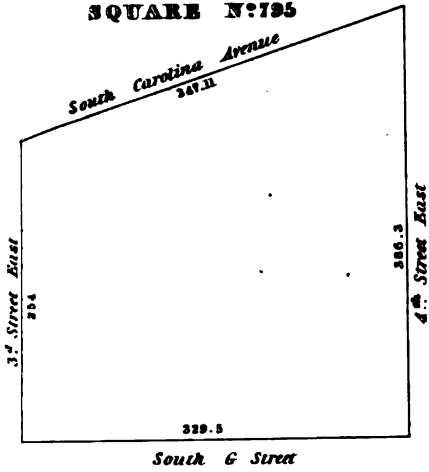

SQUARE N:796

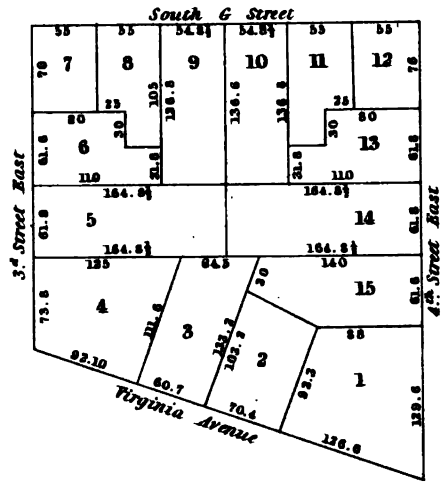

SQUARE N:797

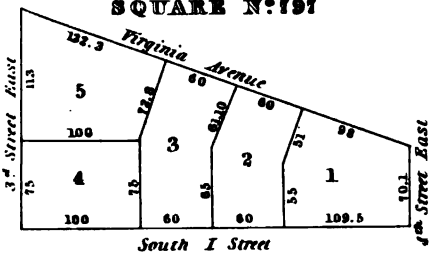

SQUARE N:798

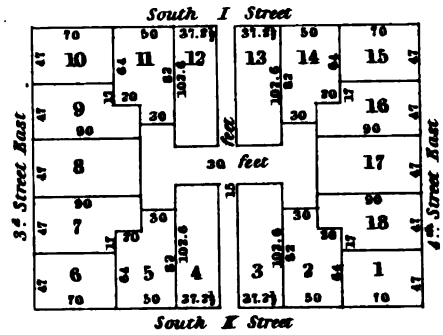

SQUARE N:799

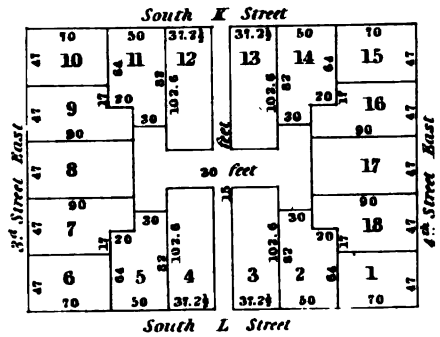

SQUARE N:800

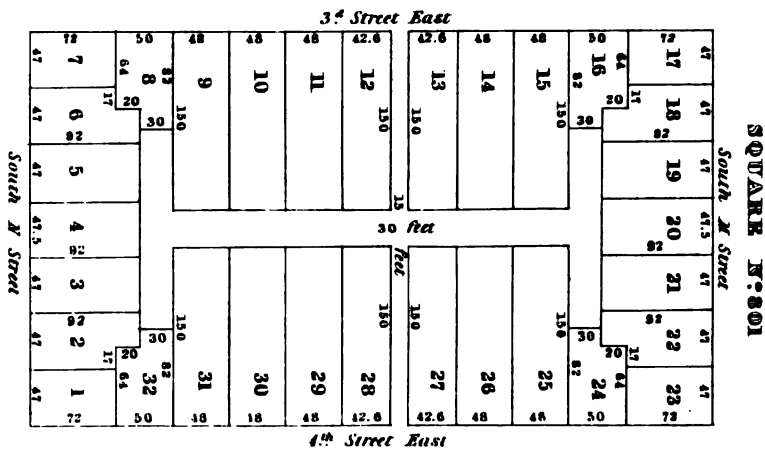
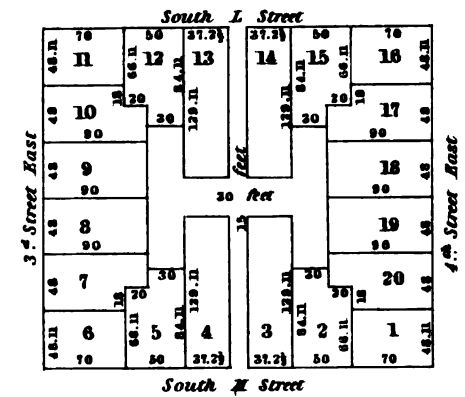

SQUARE N:801



**SQUARE N°802**

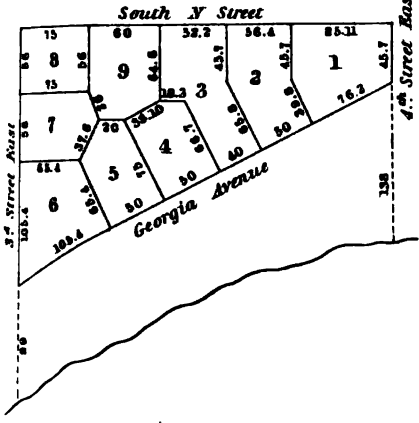

**SQUARE N°805**

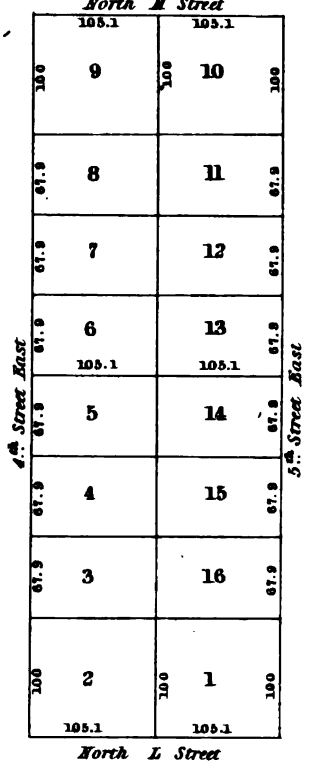

**SQUARE N°804**

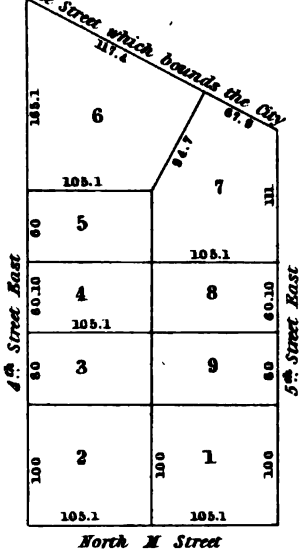

**SQUARE N°803**

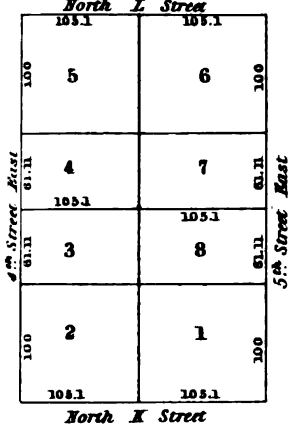

**SQUARE N°807**

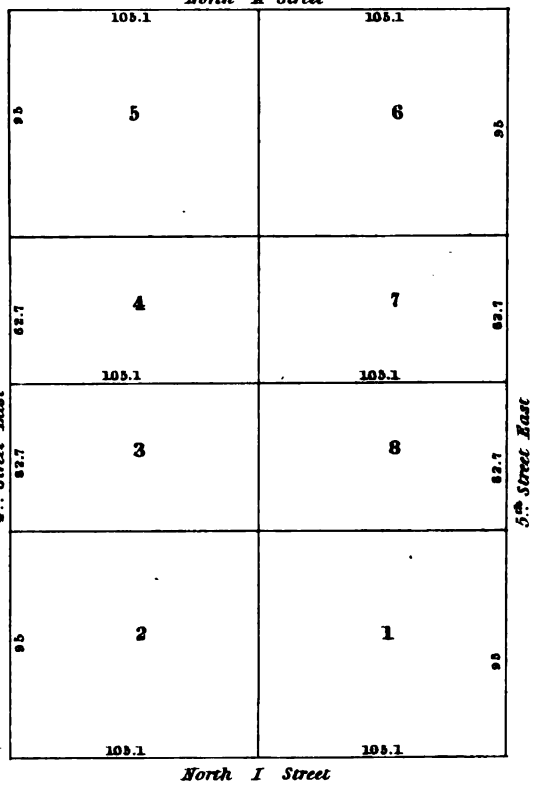

**SQUARE N°808**

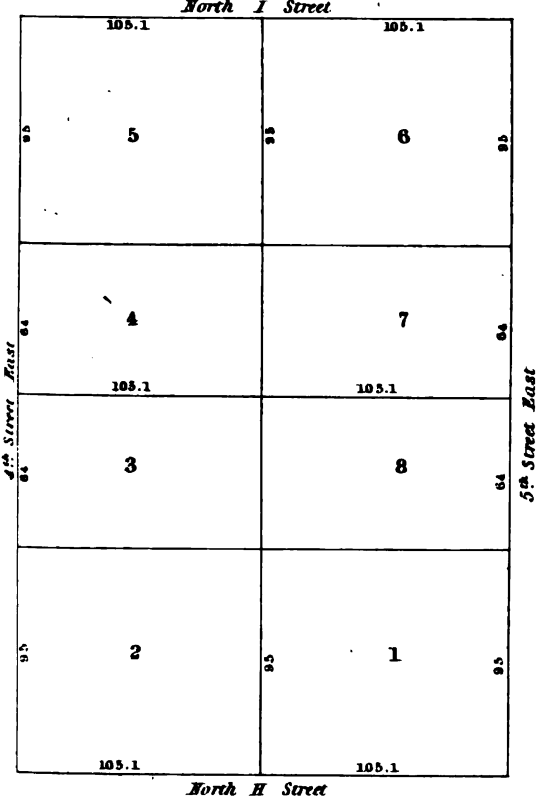

**SQUARE N°809**

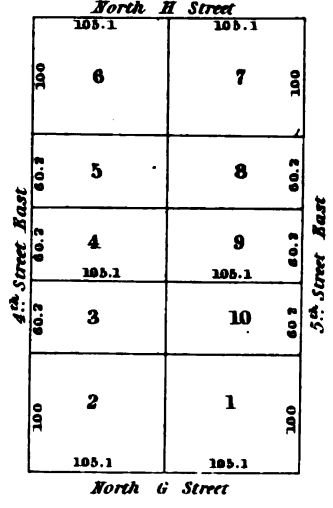

**SQUARE N°810**

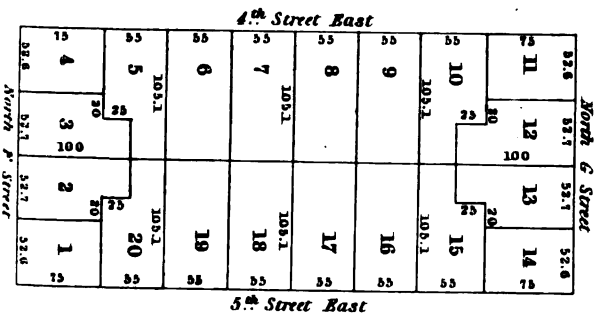





SQUARE N:811

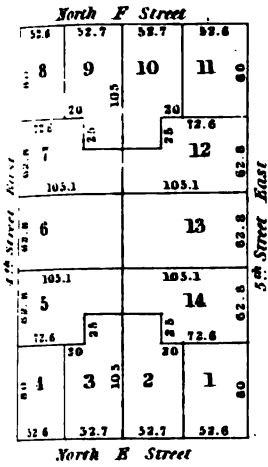

SQUARE N:812

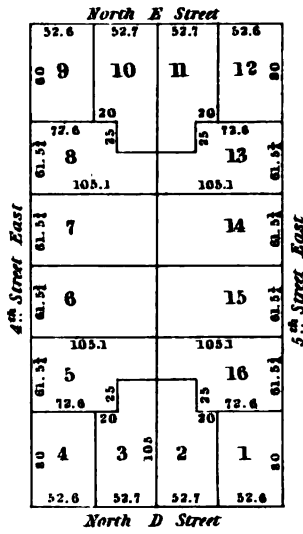

SQUARE N:813

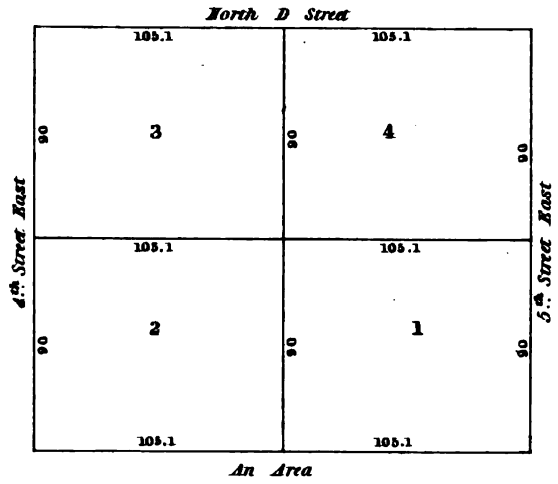

SQUARE N:814

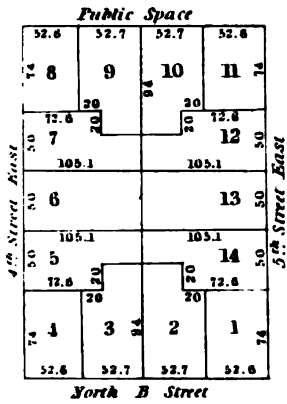

SQUARE N:815

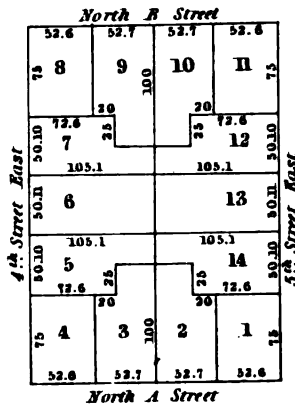

SQUARE N:816

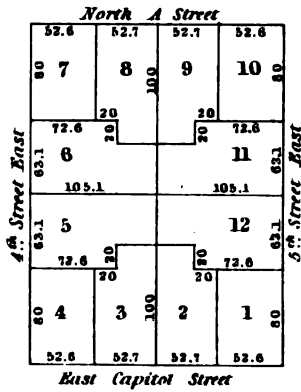

SQUARE N:817

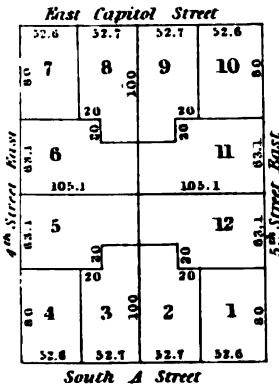

SQUARE N:818

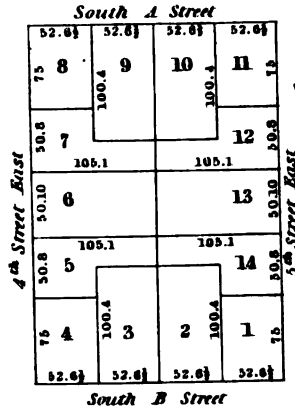

SQUARE N:819

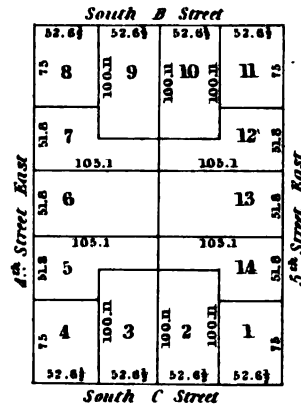

SQUARE N:820

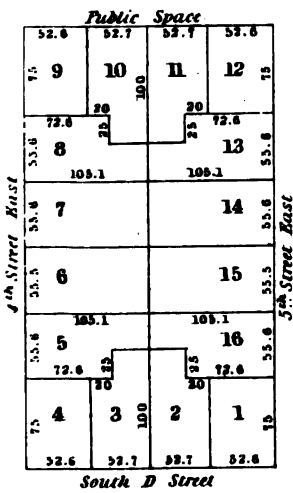

SQUARE N:821

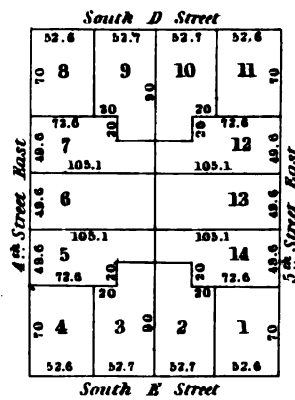

SQUARE N:822

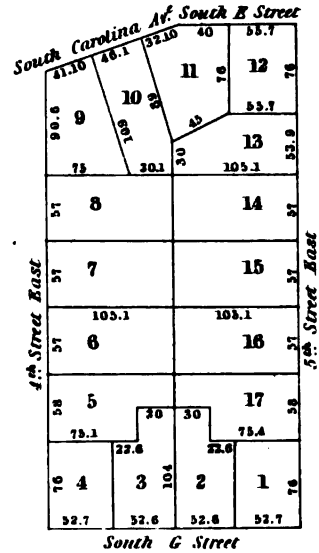

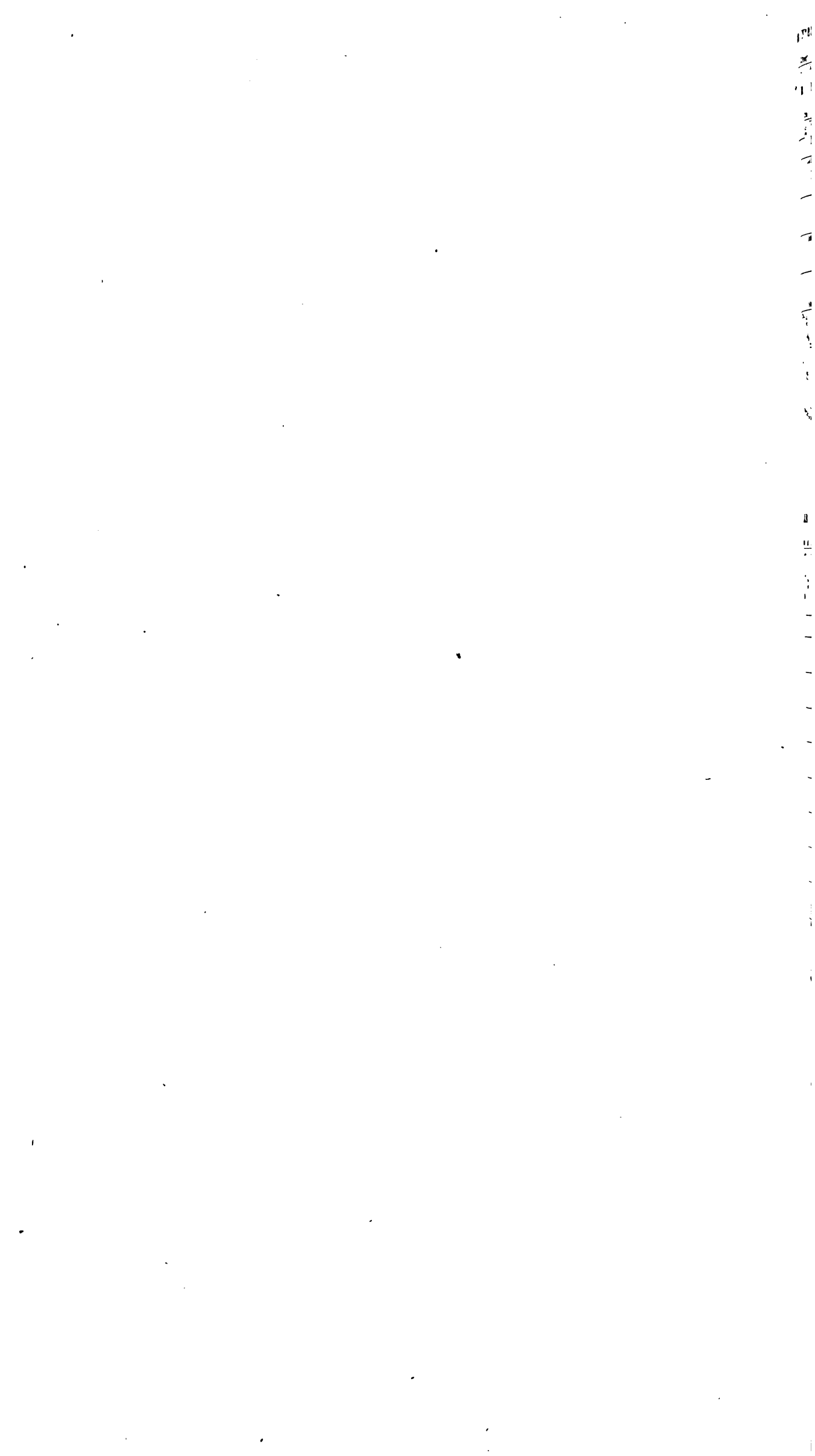

**SQUARE N:823**

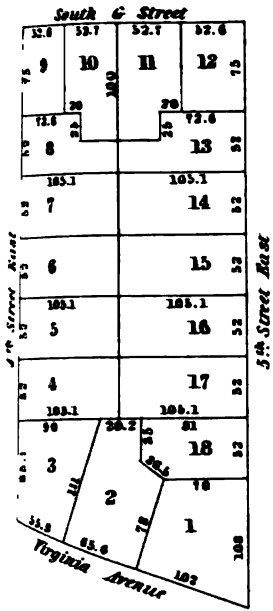

**SQUARE N:824**

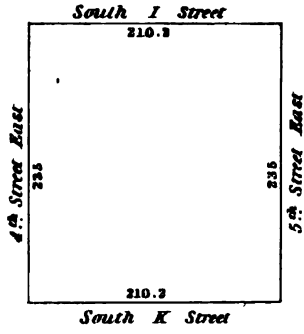

**SQUARE S. OF N:825**

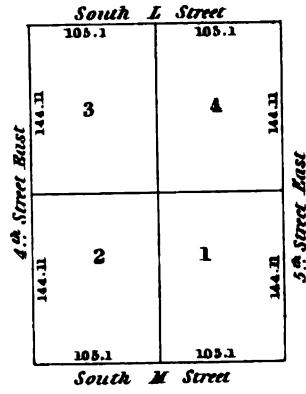

**SQUARE N:828**

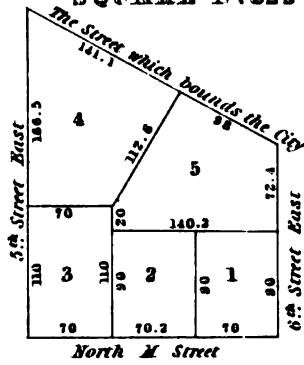

**SQUARE N:829**

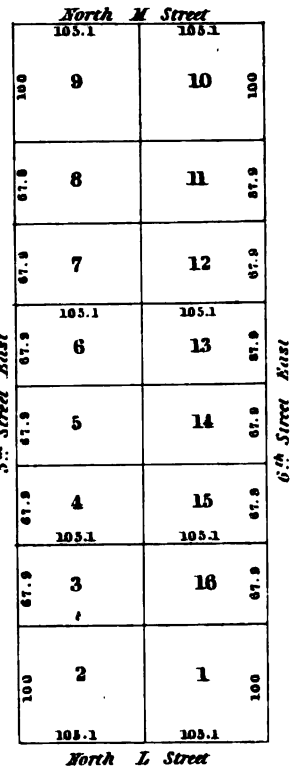

**SQUARE N:826**

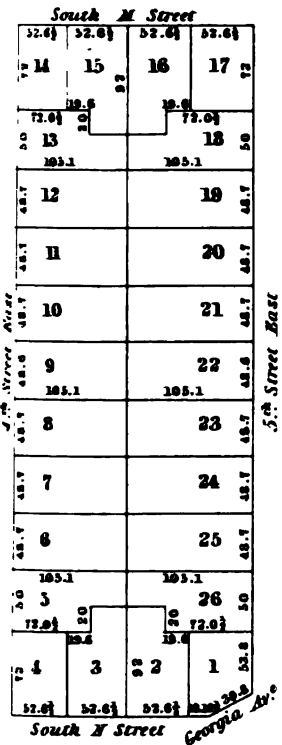

**SQUARE N:830**

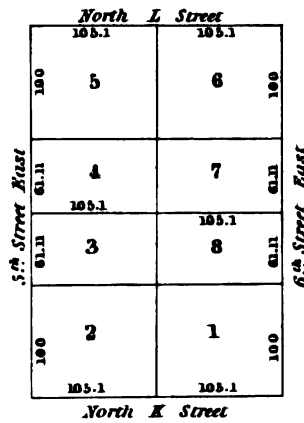

**SQUARE N:831**

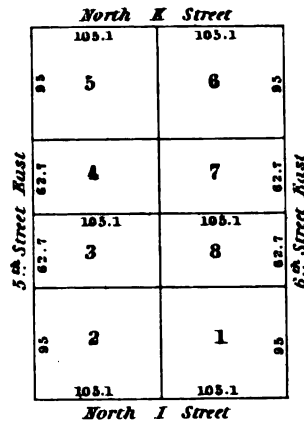

**SQUARE N:832**

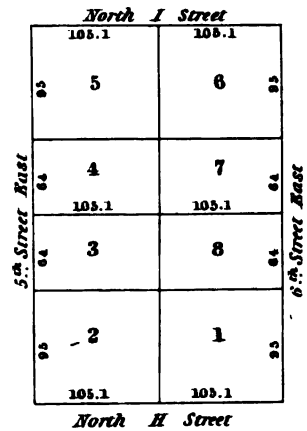

**SQUARE N:833**

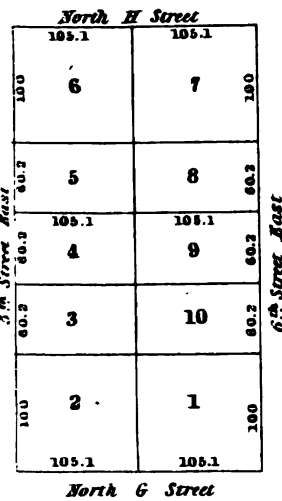

**5th Street East**

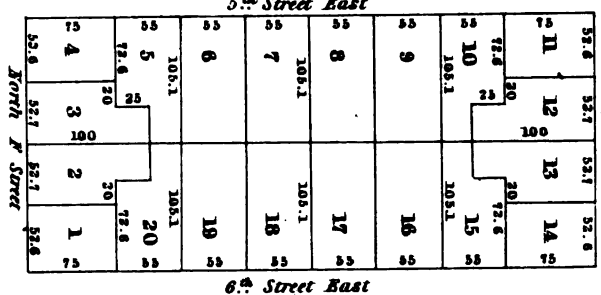

**SQUARE N:834**



SQUARE N°835

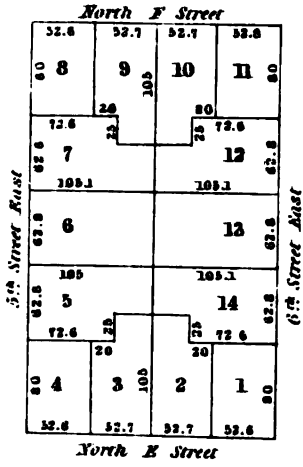

SQUARE N°838

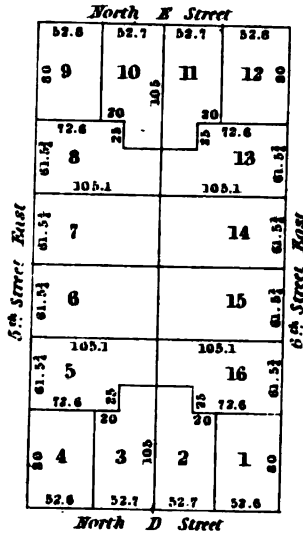

SQUARE N°836

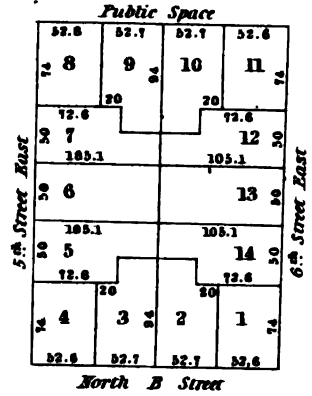

SQUARE N°837

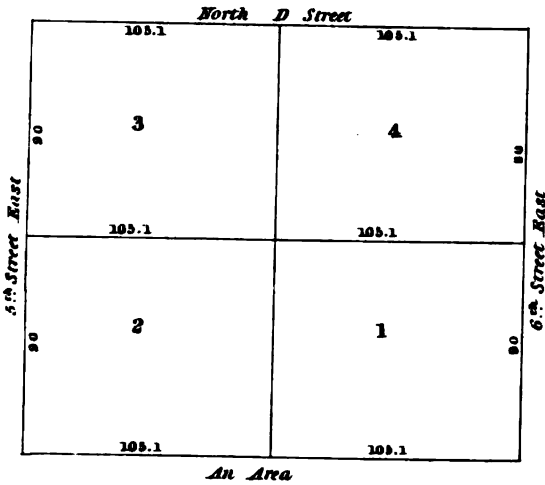

SQUARE N°839

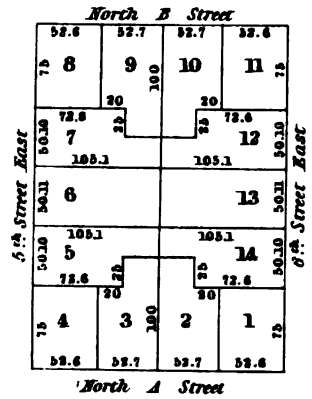

SQUARE N°840

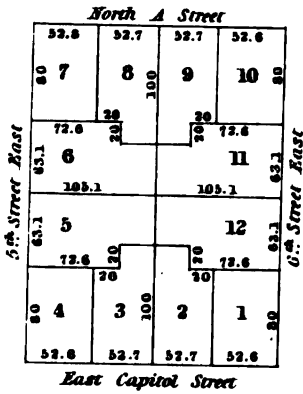

SQUARE N°841

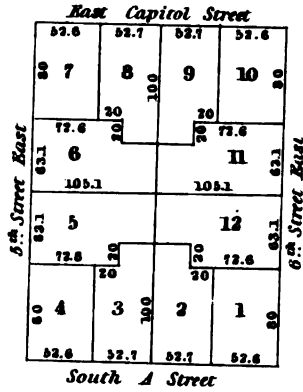

SQUARE N°842

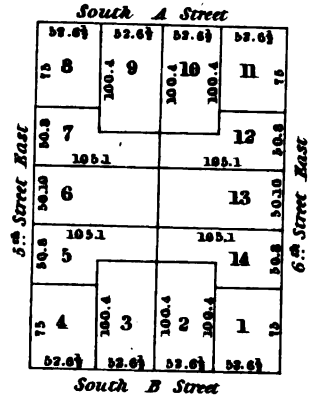

SQUARE N°844

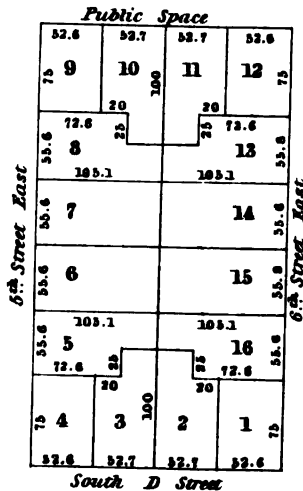

SQUARE N°843

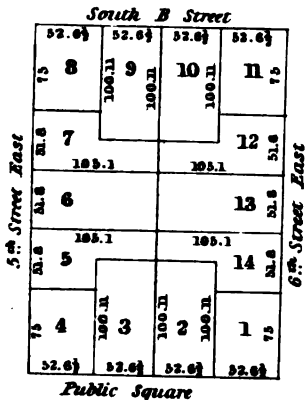

SQUARE N°846

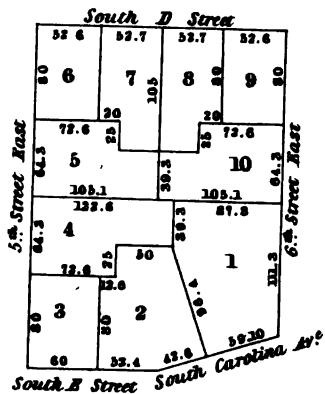



**SQUARE N°853**

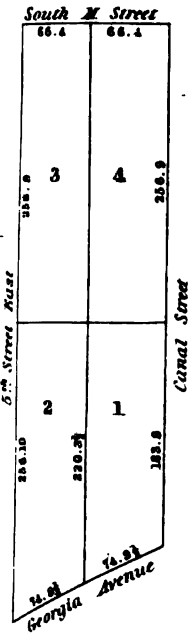

**SQUARE N°847**

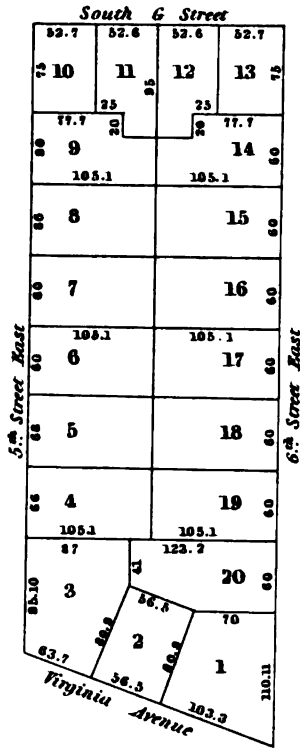

**SQUARE N°849**

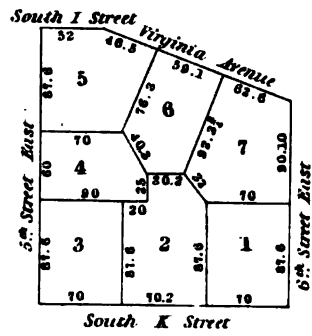

**SQUARE N°848**

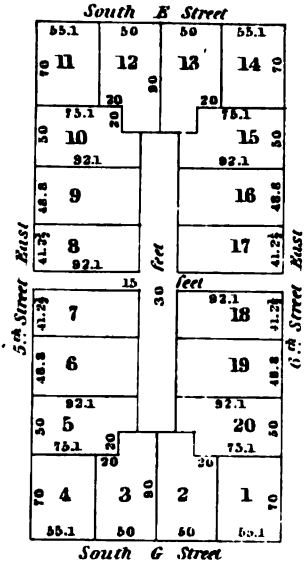

**SQUARE N°855**

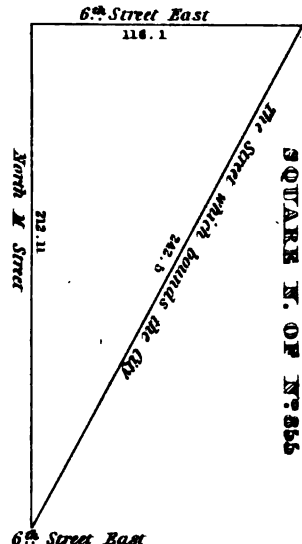
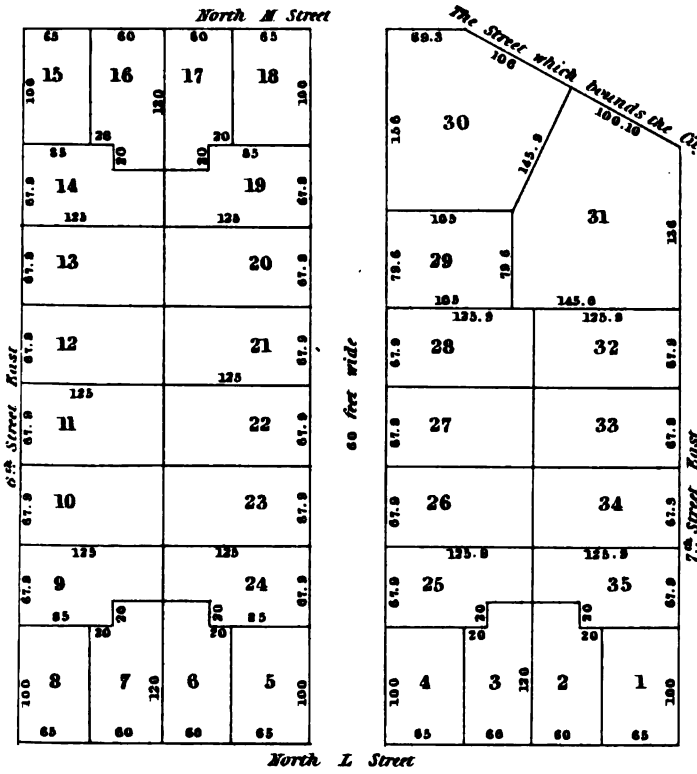

**SQUARE N. OF N°855**

**SQUARE N°856**

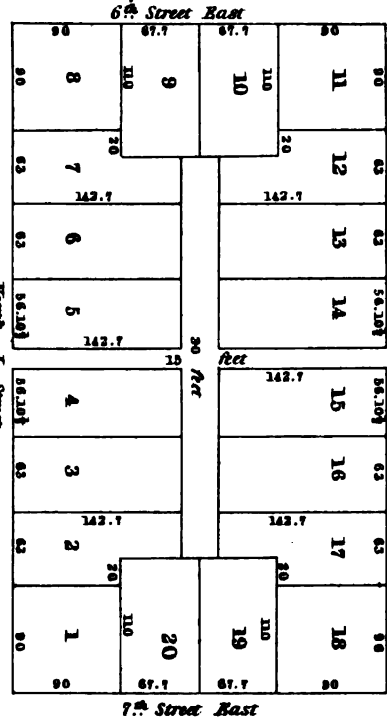
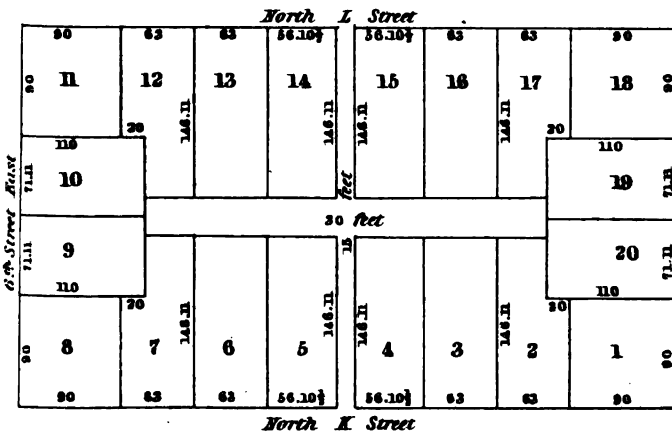

**SQUARE N°857**





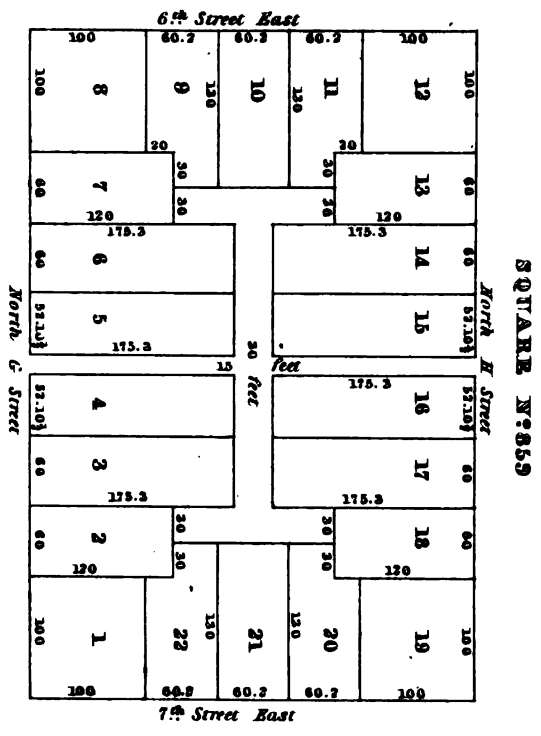
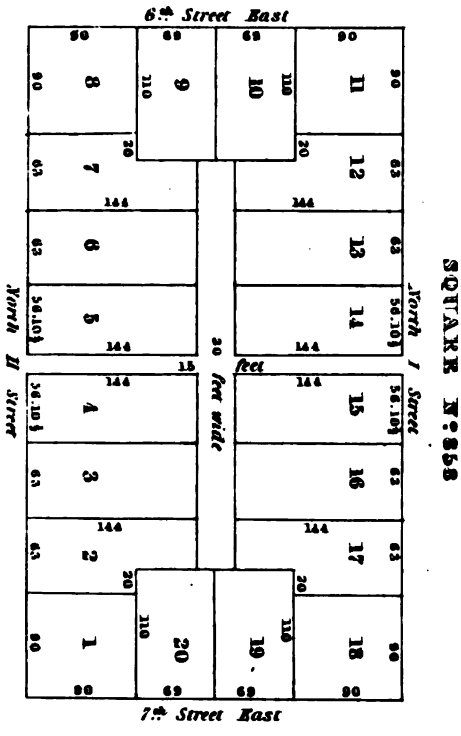

SQUARE N:860

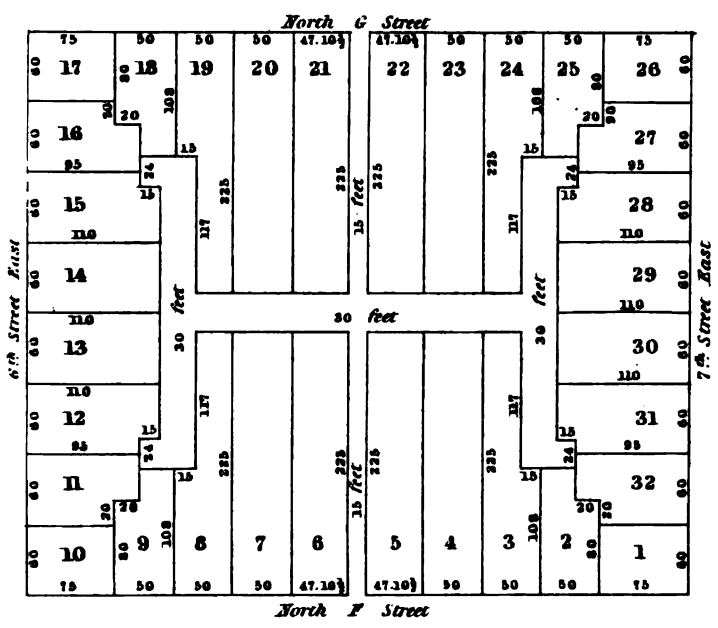

SQUARE N:862

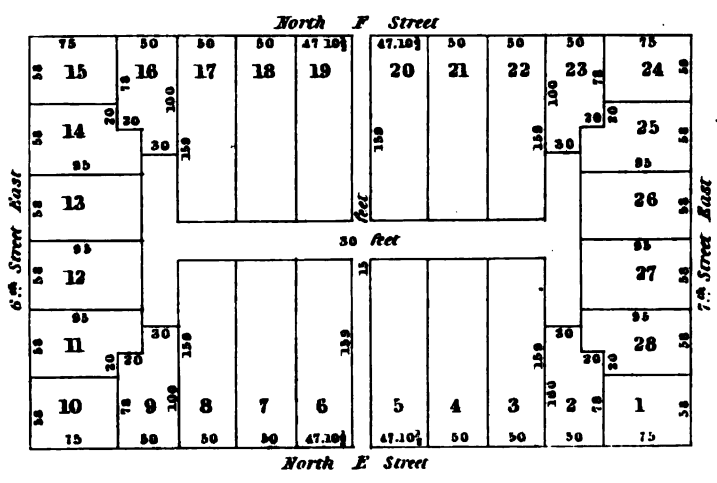

SQUARE N:863

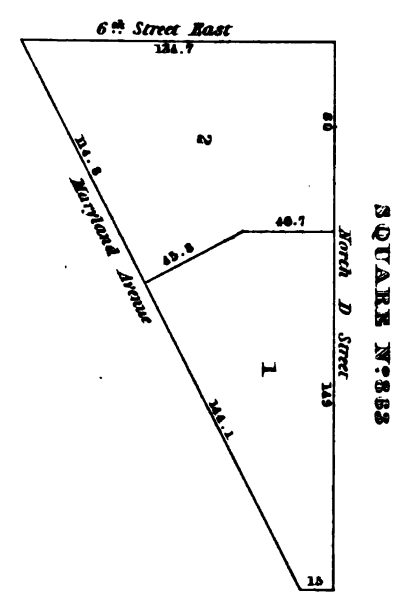
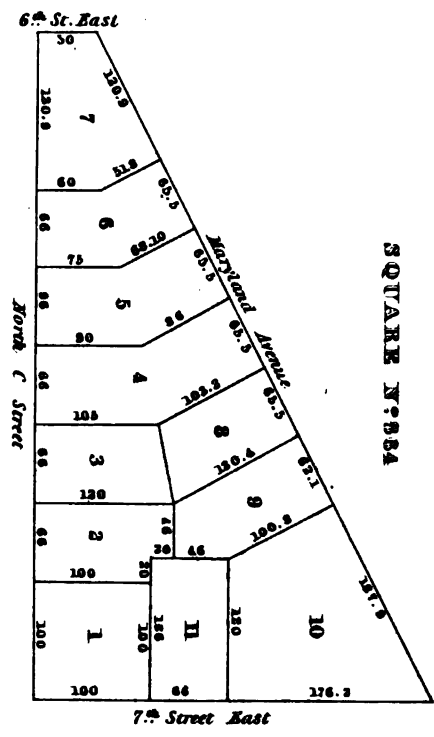
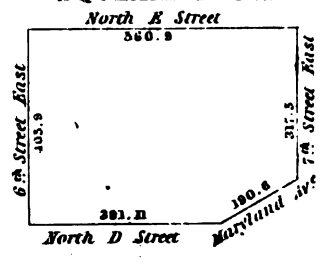

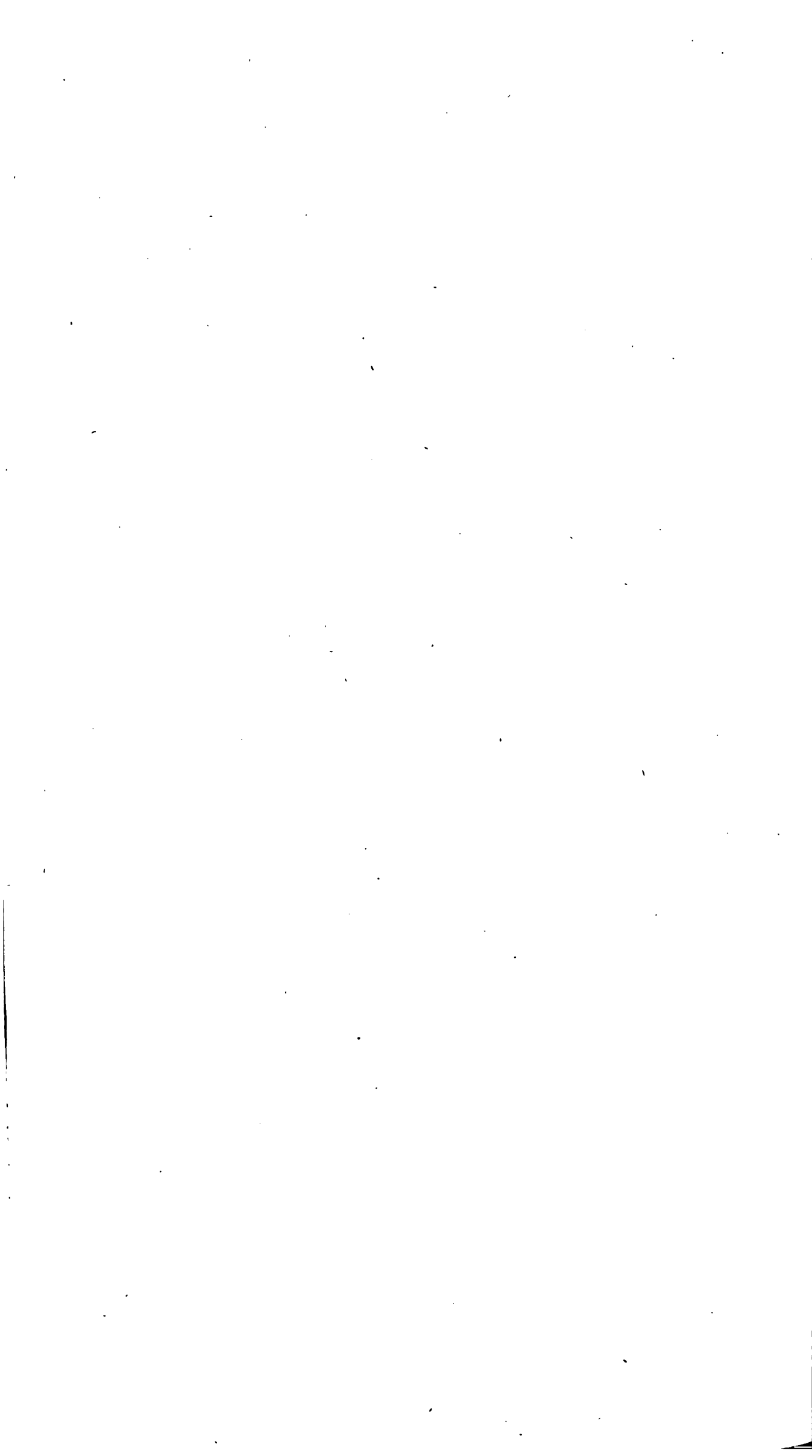

SQUARE N:865

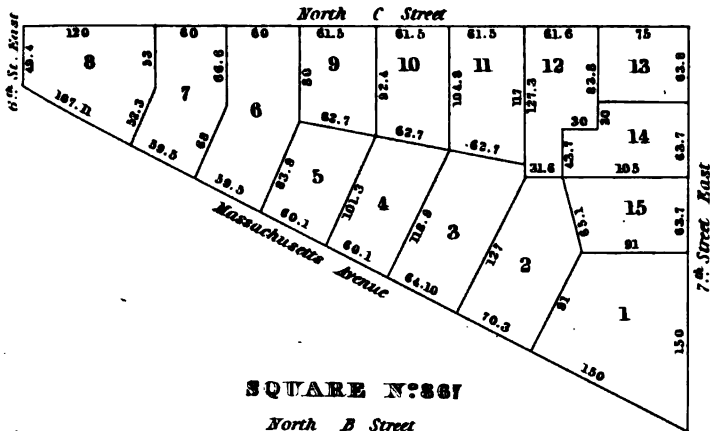

SQUARE N:867

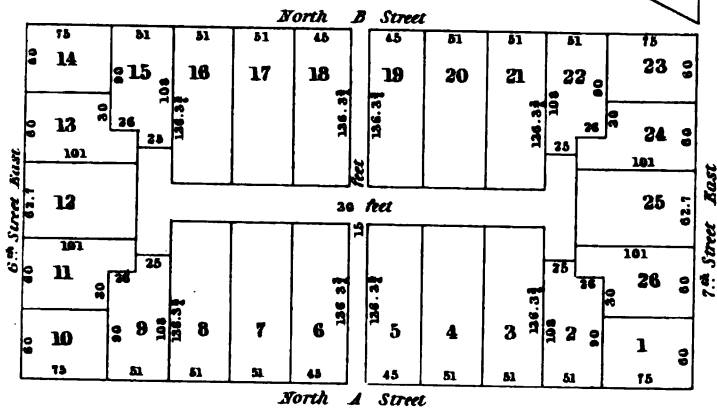

SQUARE N:868

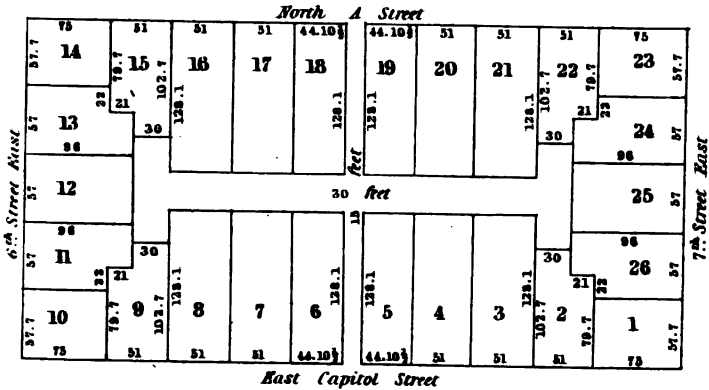

SQUARE N:869

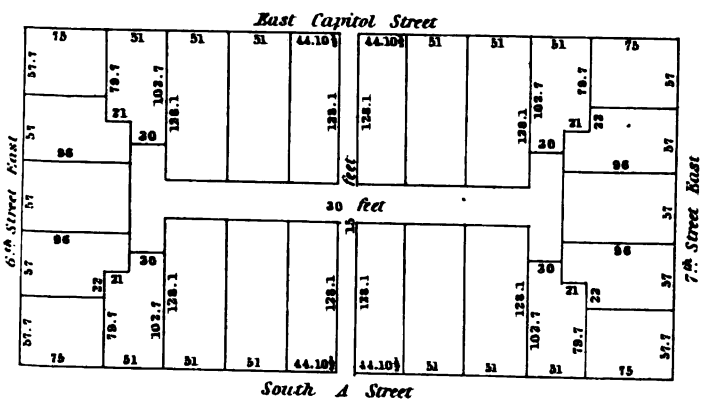

SQUARE N:870

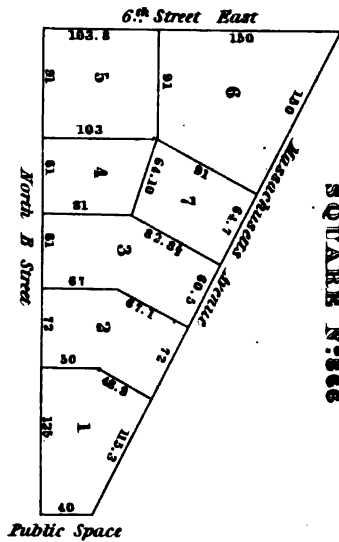
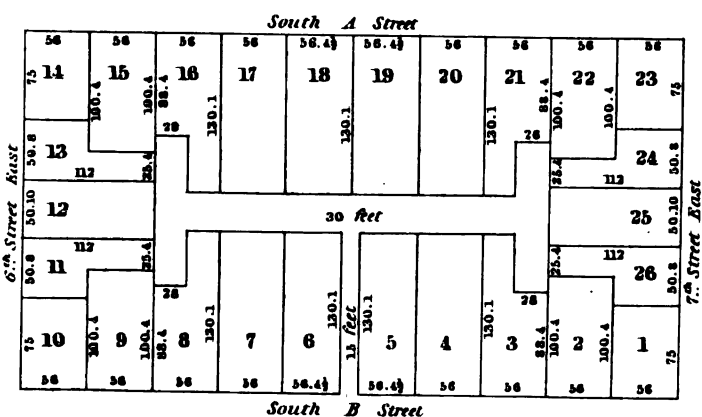

SQUARE N:866

Public Space

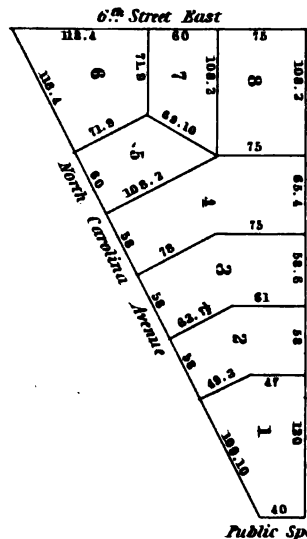

SQUARE N:871

Public Space

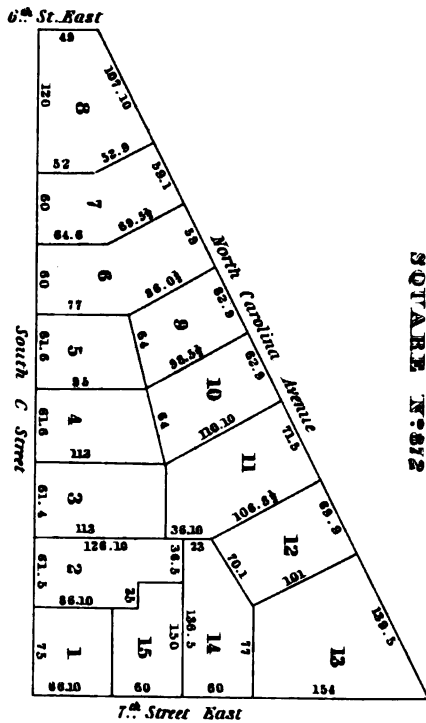

SQUARE N:872



SQUARE N:873

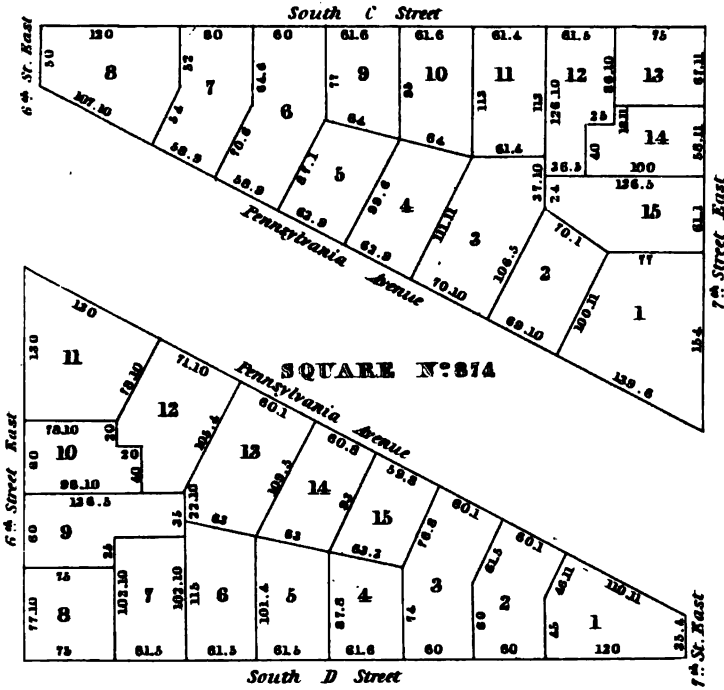

SQUARE N:874

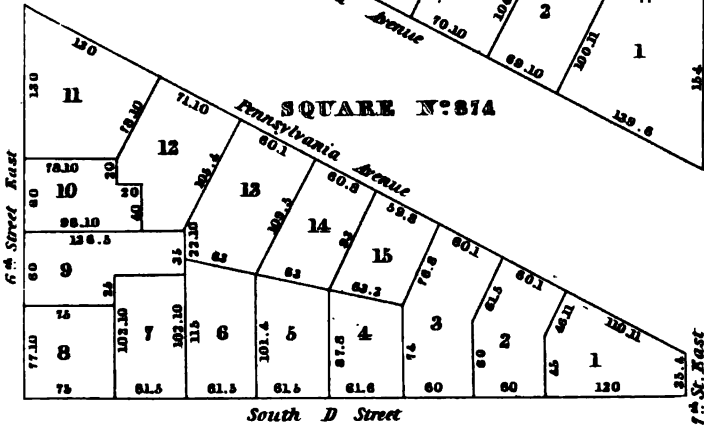

SQUARE N:876

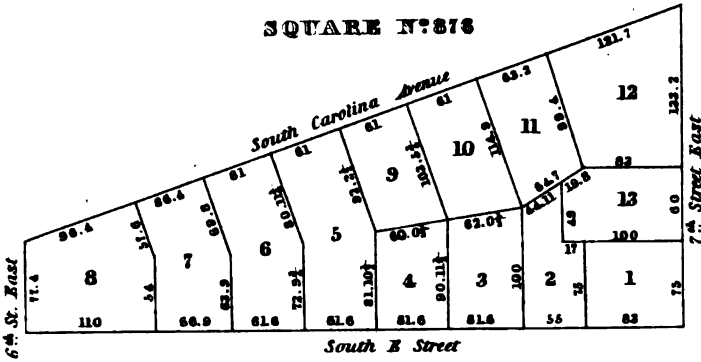

SQUARE N:877

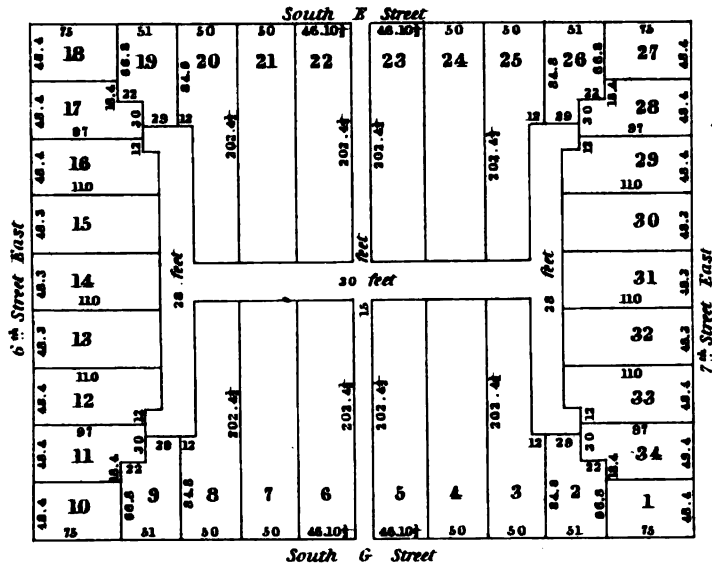

SQUARE N:881

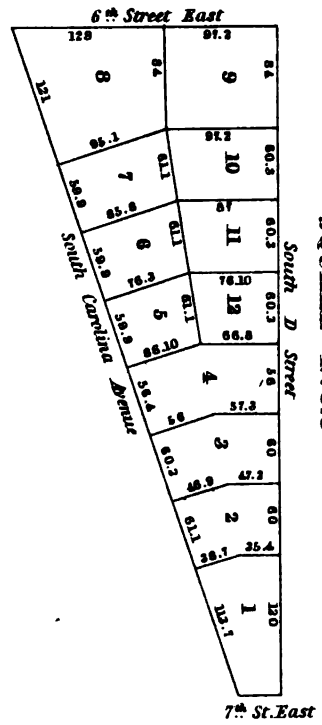
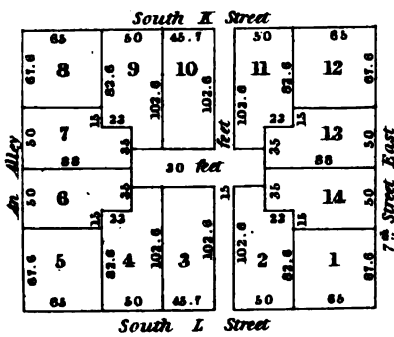

SQUARE N:815

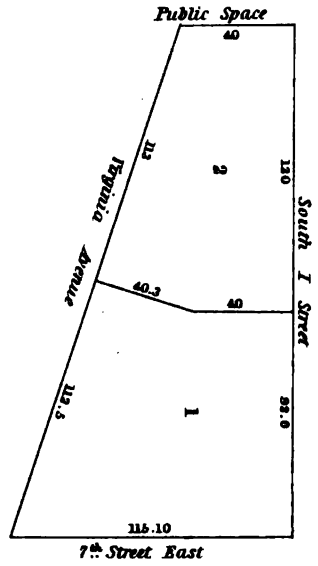

SQUARE N:819

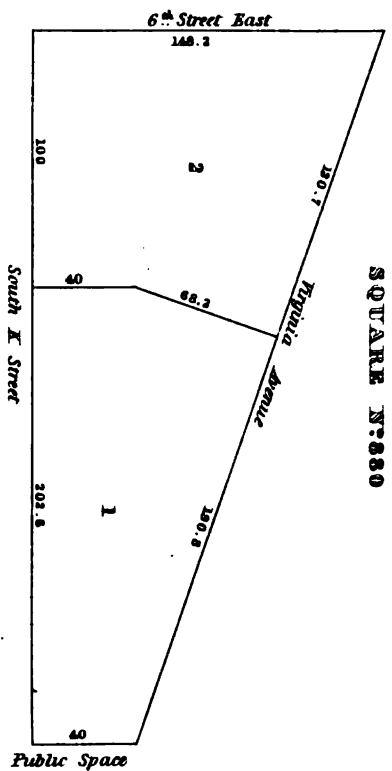

SQUARE N:880









SQUARE N:901

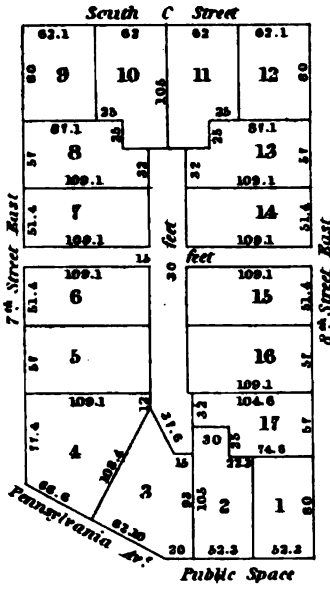

SQUARE N:902

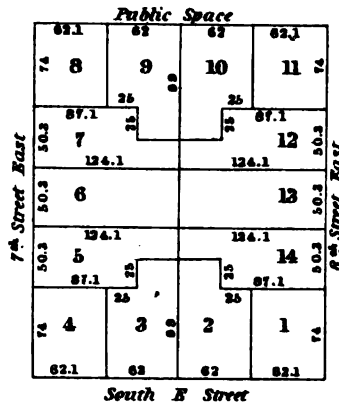

SQUARE N:903

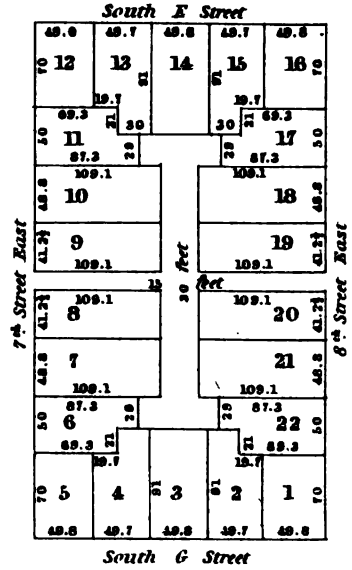

SQUARE N:910

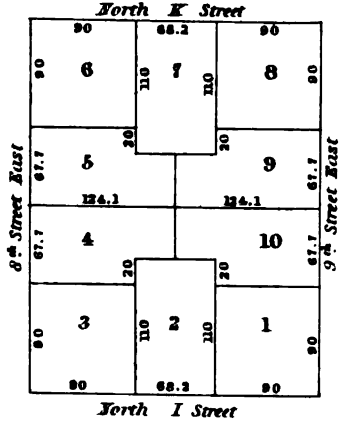

SQUARE N:906

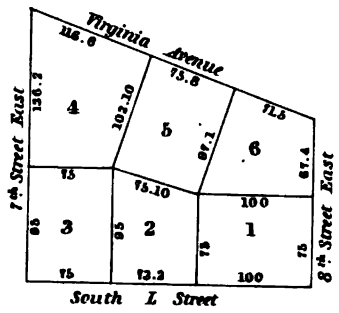

SQUARE N:904

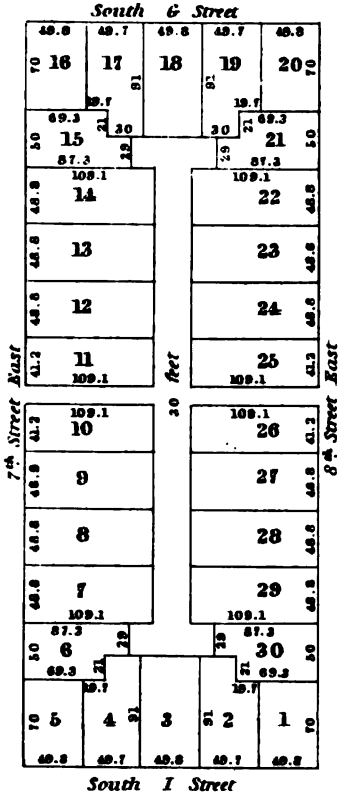

SQUARE N:907

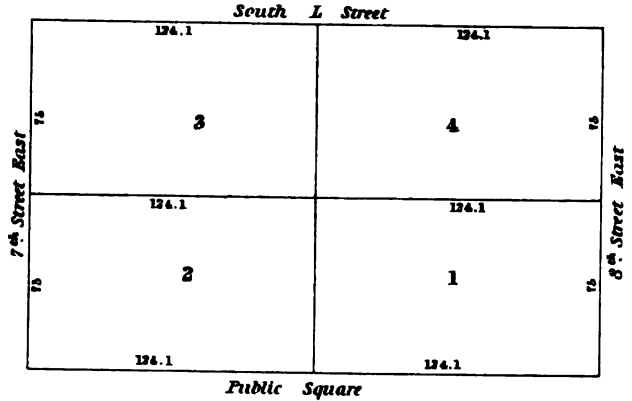

SQUARE N:908

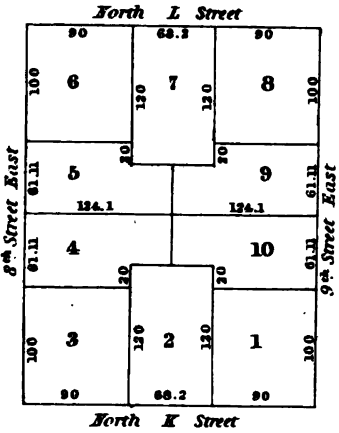

SQUARE N:908

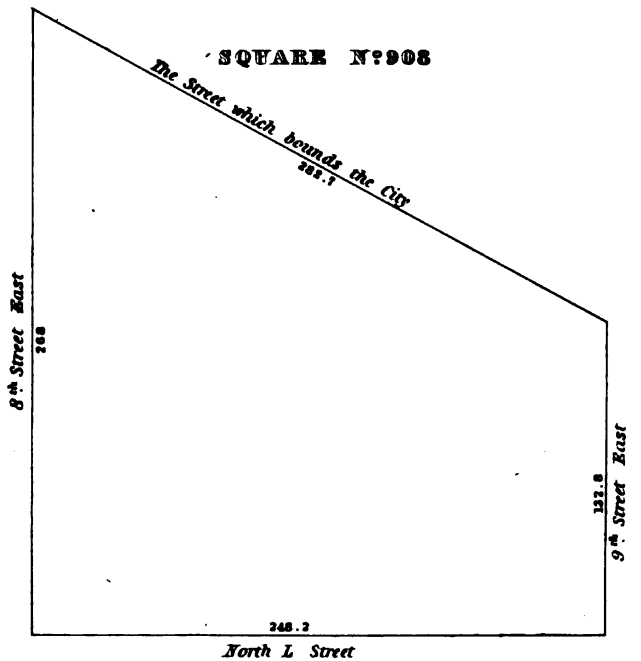

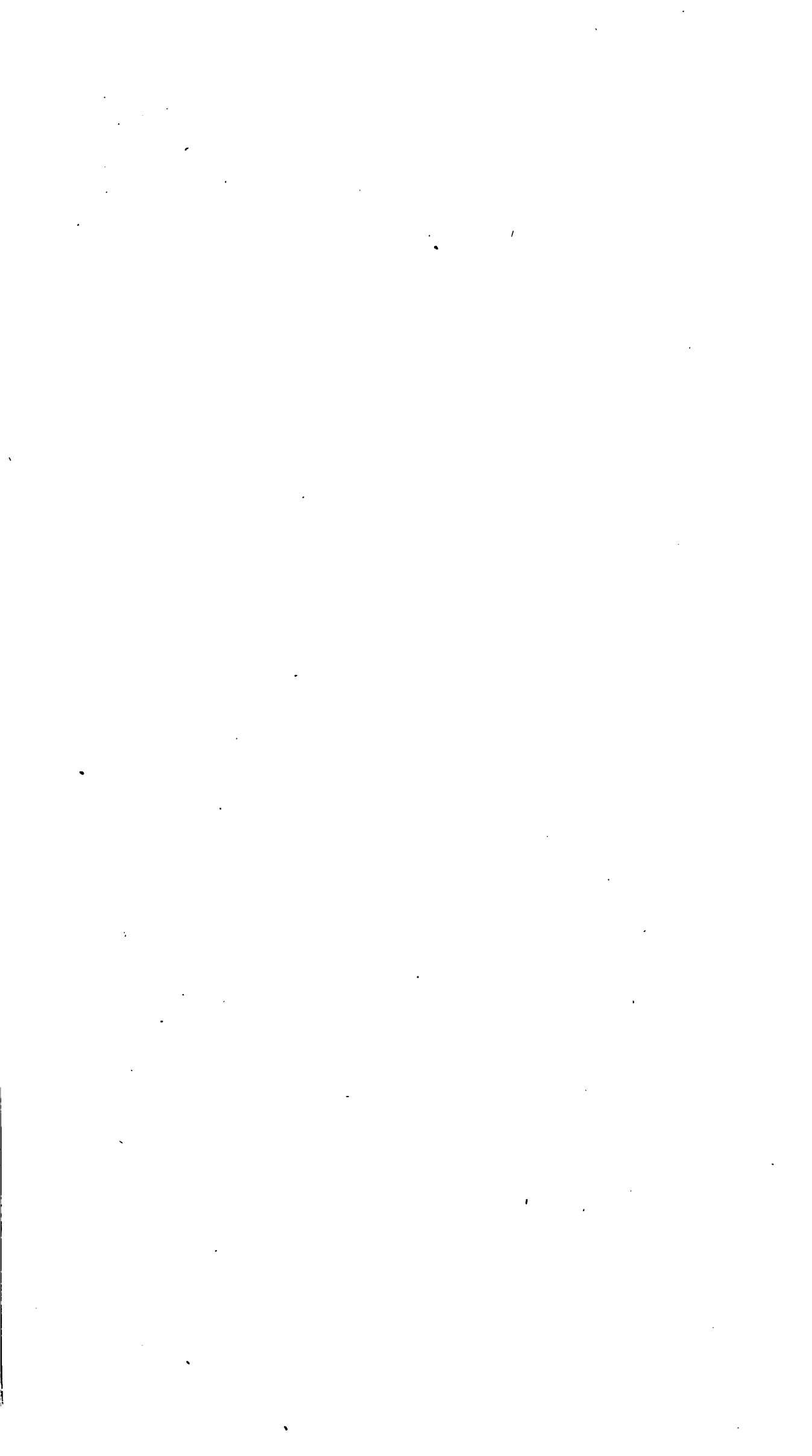

**SQUARE N:911**

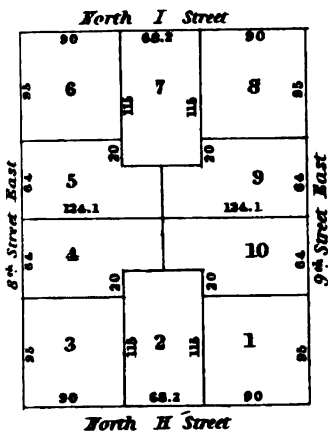

**SQUARE N:912**

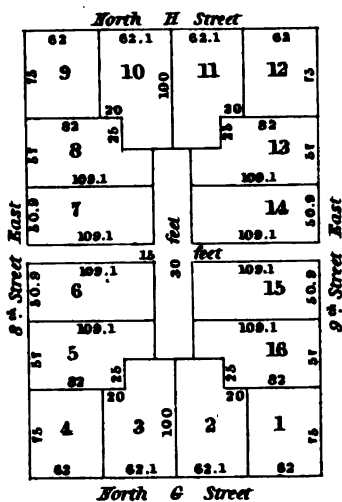

**SQUARE N:913**

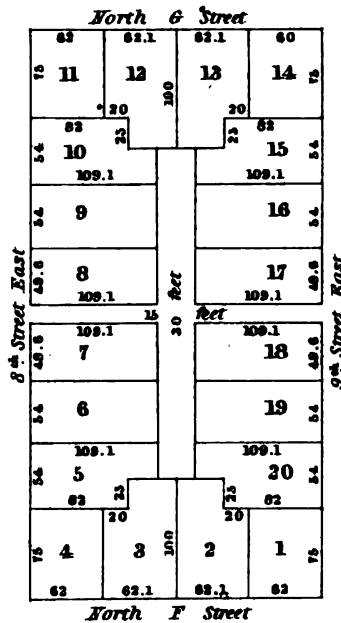

**SQUARE N:914**

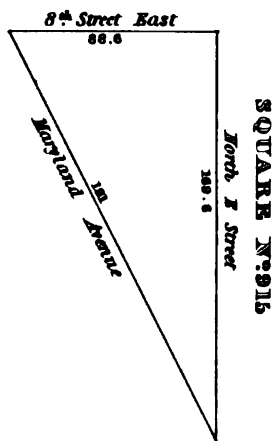
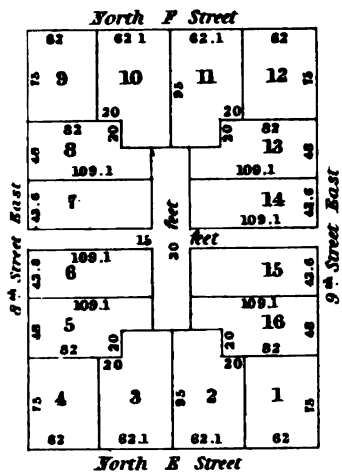

**SQUARE S. OF N:915**

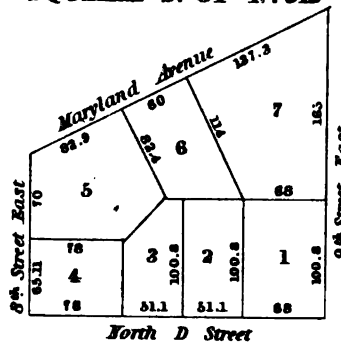

**SQUARE N:916**

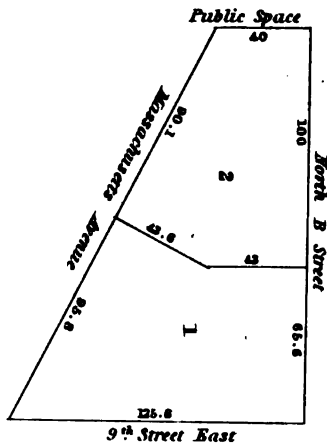
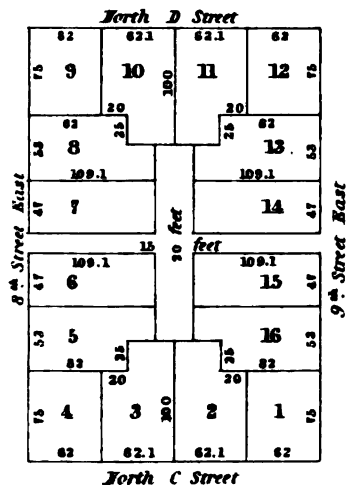

**SQUARE S. OF N:917**

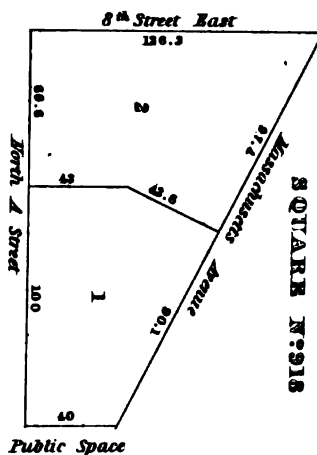

**SQUARE N:919**

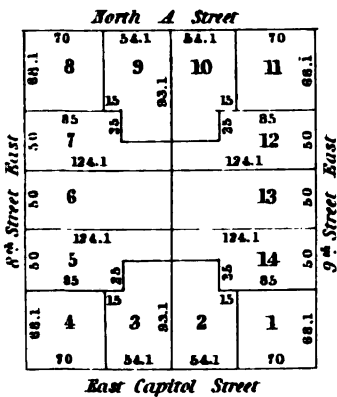

**SQUARE N:920**

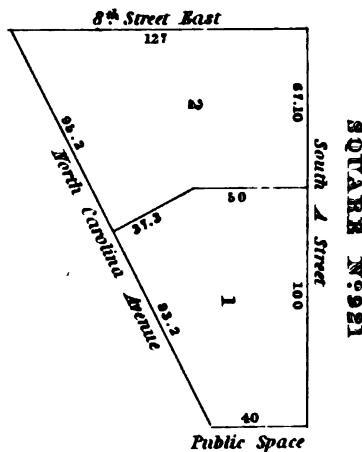
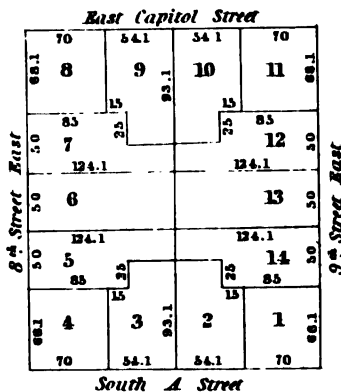

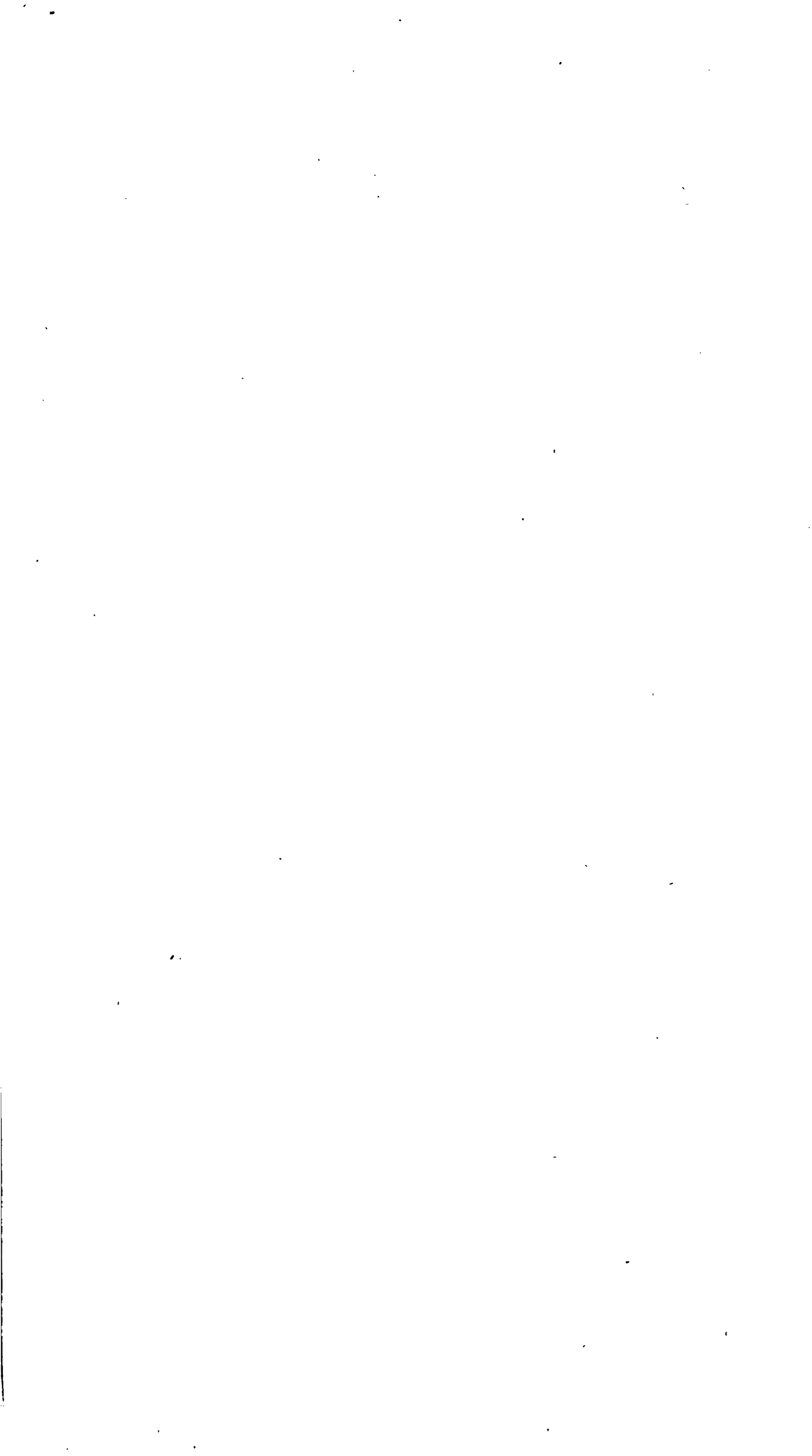

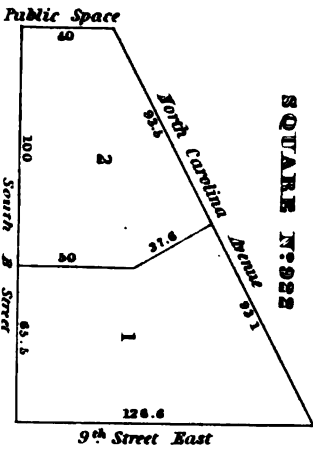

**SQUARE N:923**

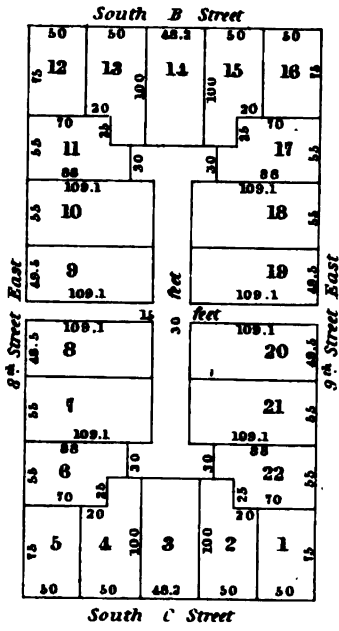

**SQUARE N:924**

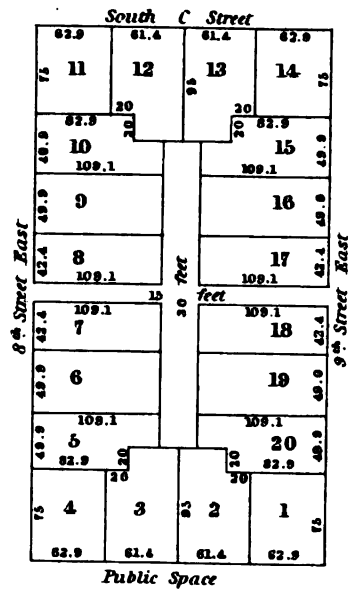

**SQUARE N:925**

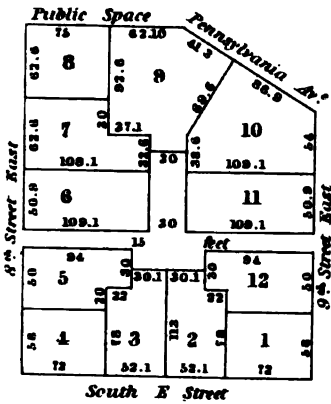

**SQUARE N:926**

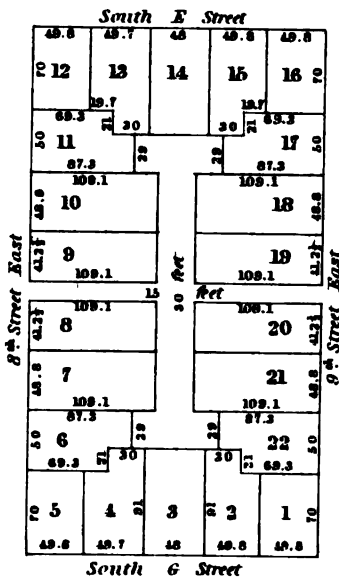

**SQUARE N:927**

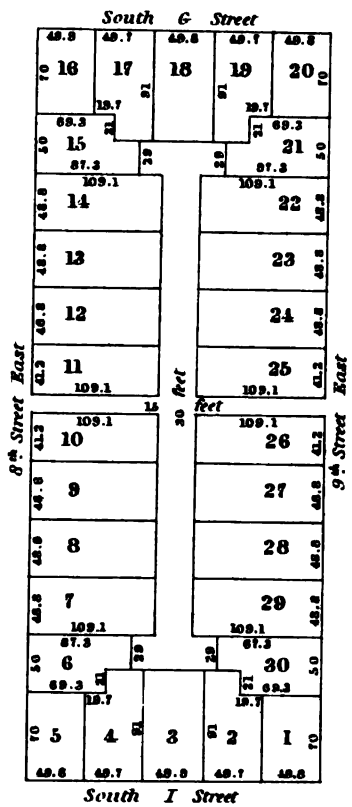

**SQUARE N:928**

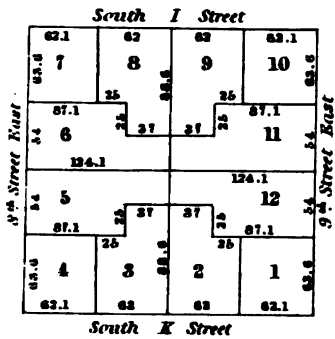

**8th Street East**

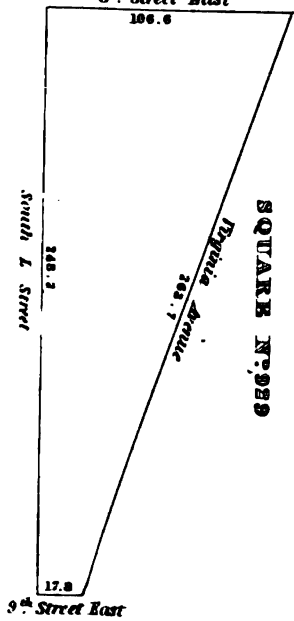

**8th Street East**

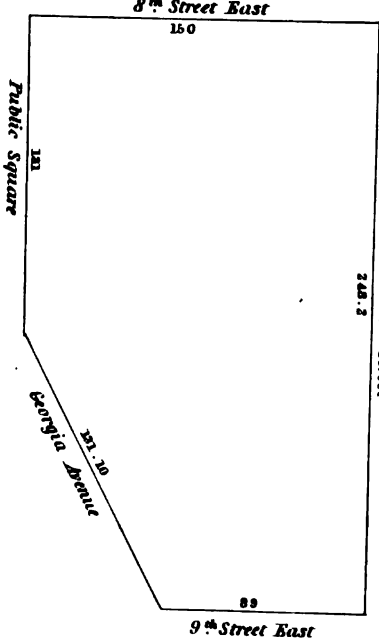

**SQUARE N:931**

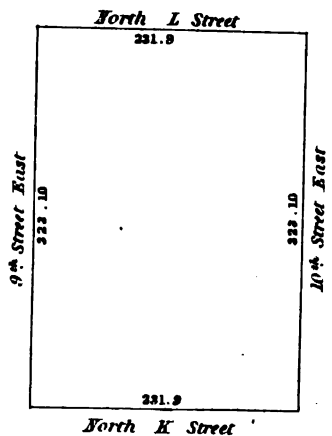



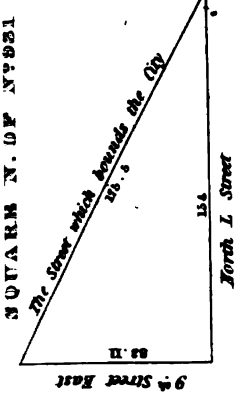

**SQUARE N°932**

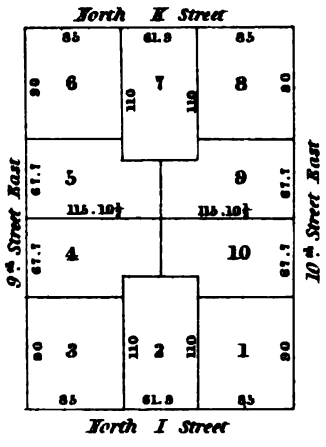

**SQUARE N°933**

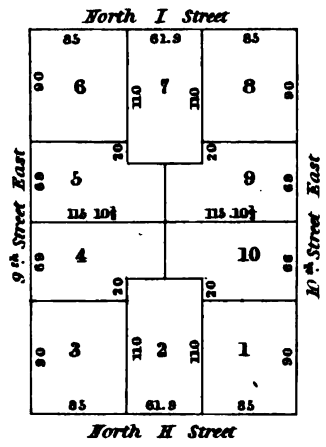

**SQUARE N°936**

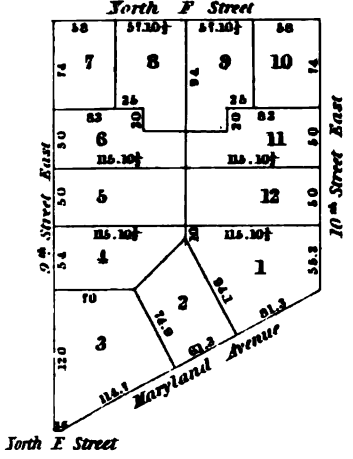

**SQUARE N°937**

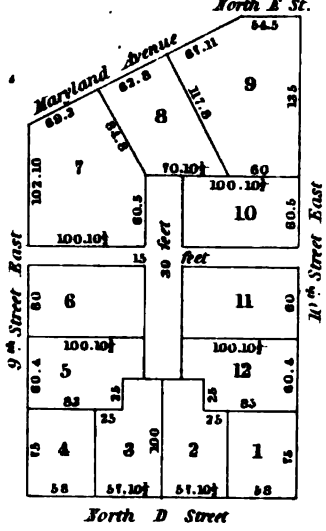

**SQUARE N°938**

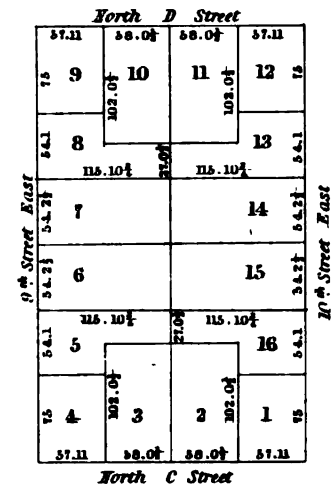

**SQUARE N°939**

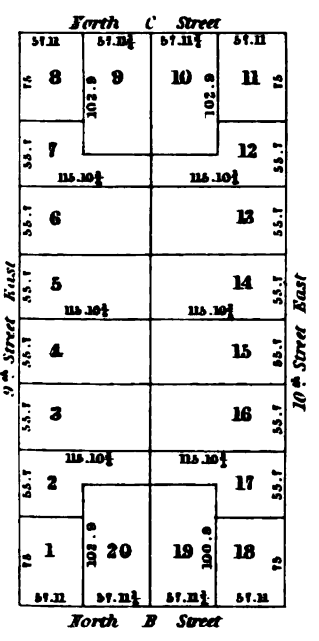

**SQUARE N°940**

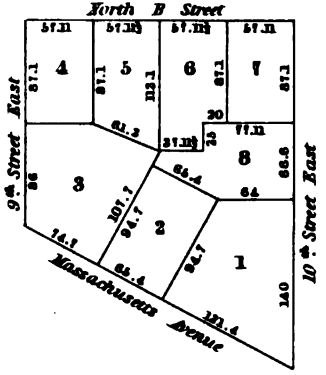

**SQUARE N°941**

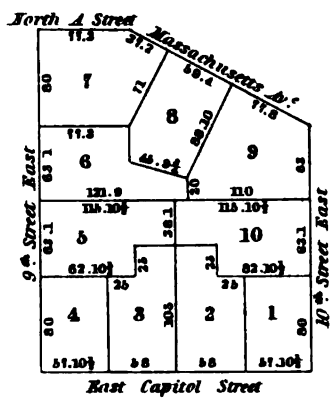

**SQUARE N°944**

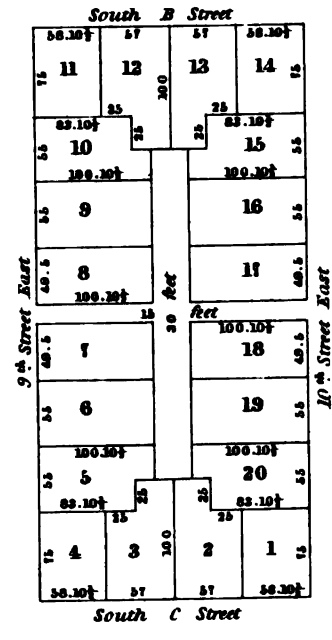

**SQUARE N°942**

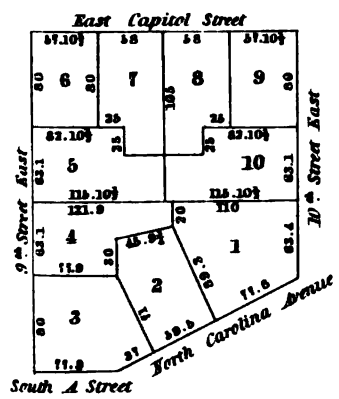

**SQUARE N°943**

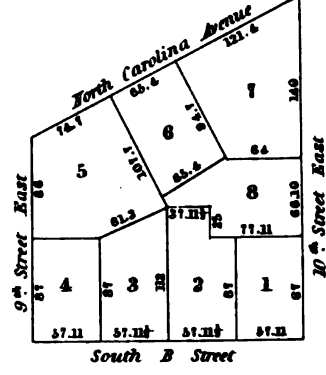



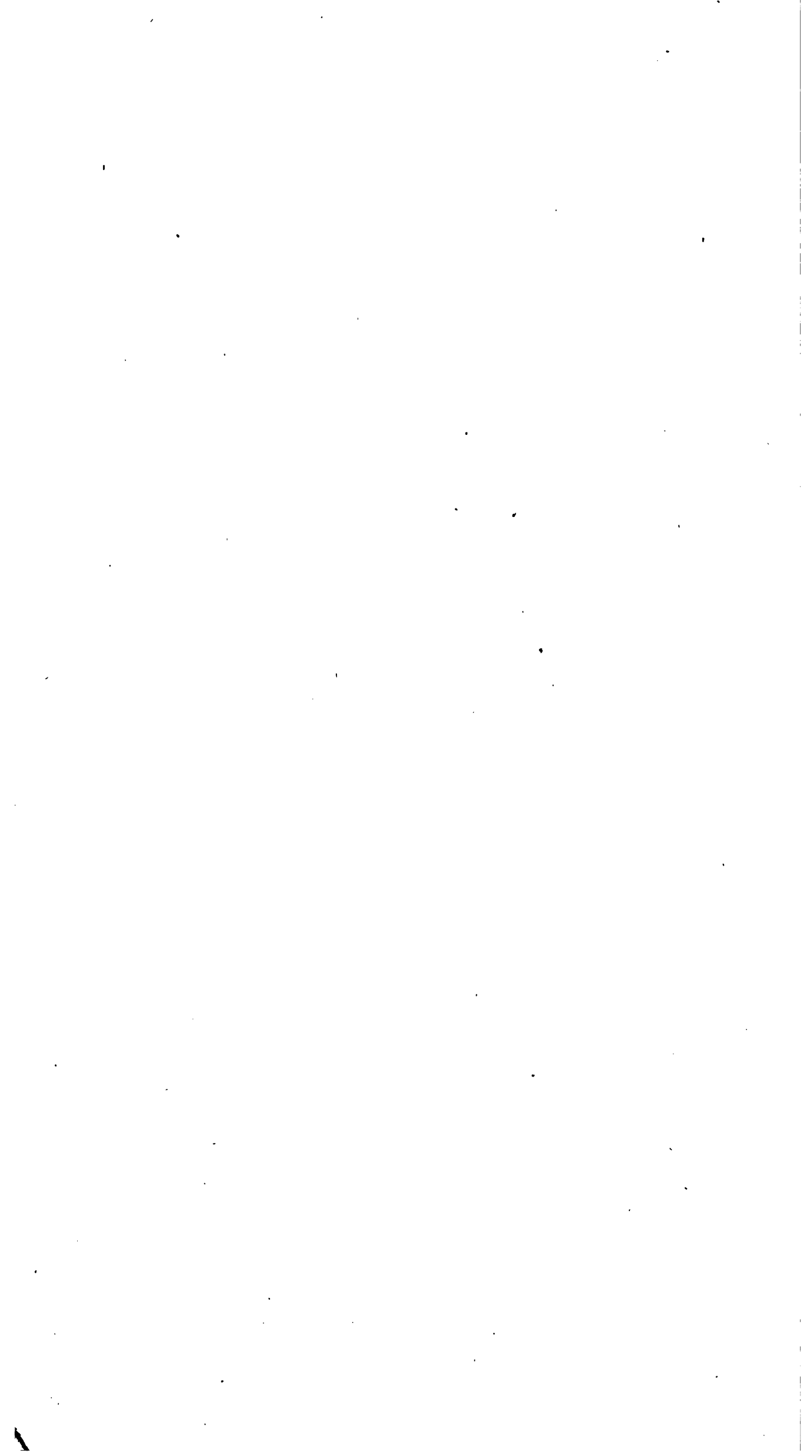

**SQUARE N°945**

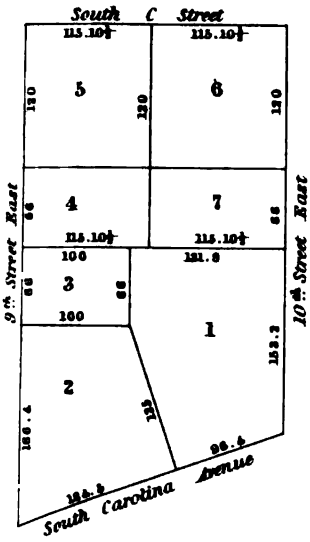

**9th Street East**

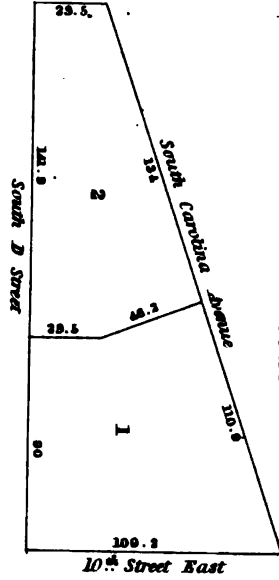

**SQUARE N°946**

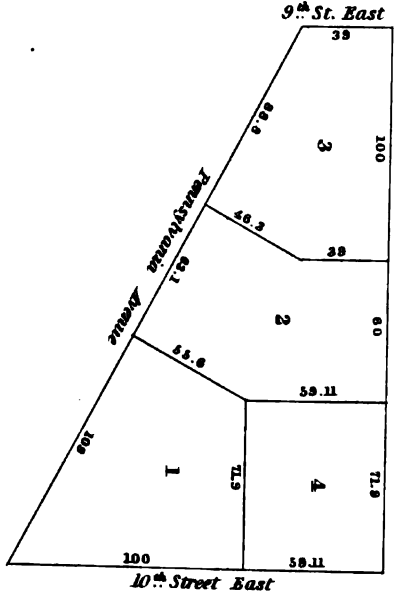

**SQUARE N°947**

**SQUARE N°948**

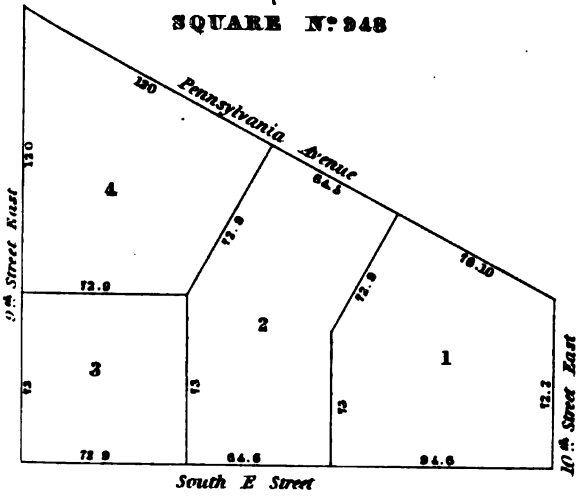

**SQUARE N°949**

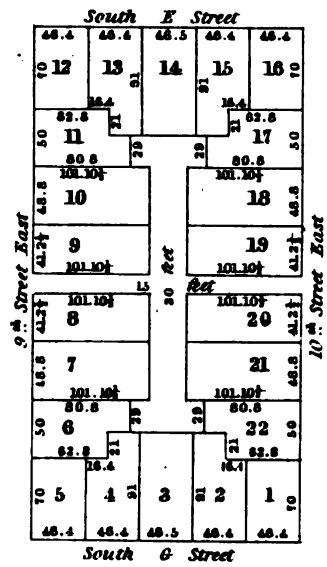

**SQUARE N°950**

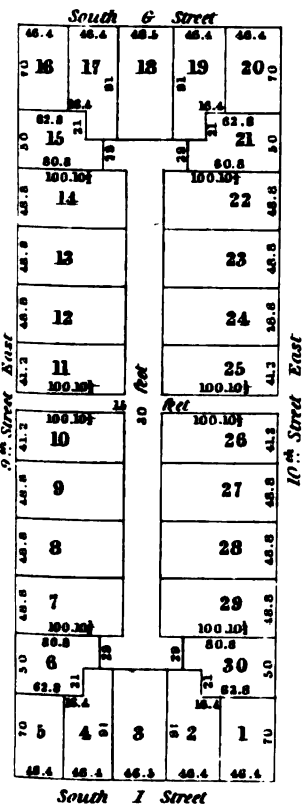

**SQUARE N°951**

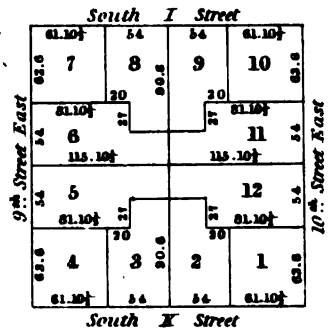

**SQUARE 3. OF N°951**

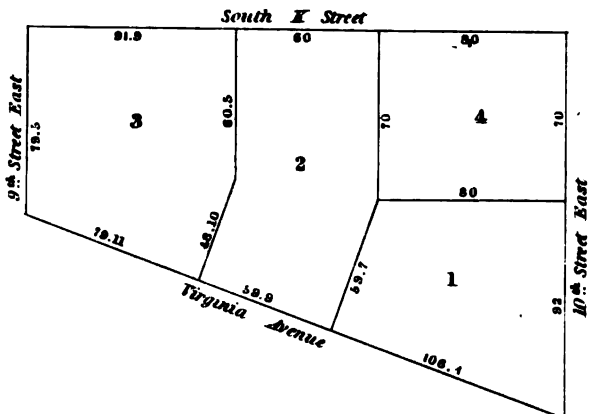



SQUARE N°952

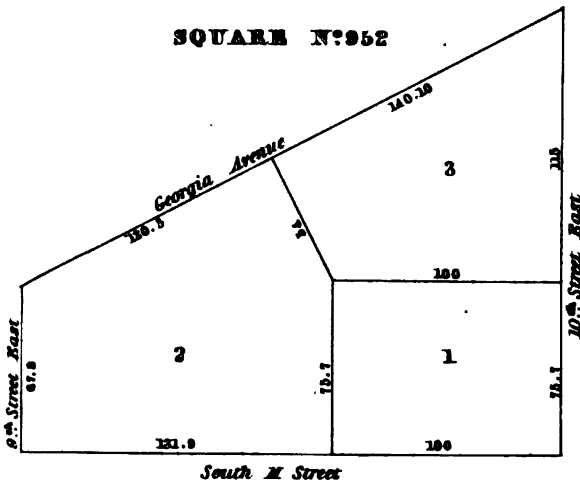

SQUARE N°953

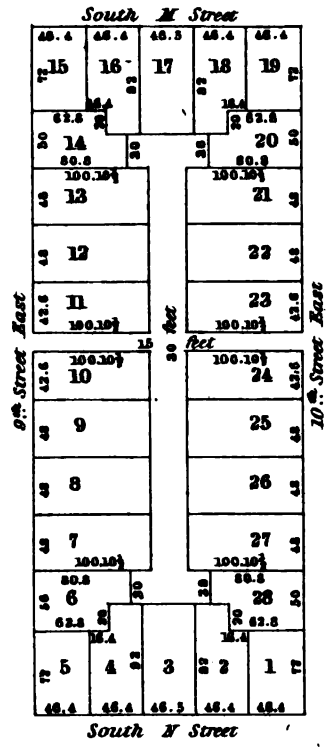

SQUARE N°954

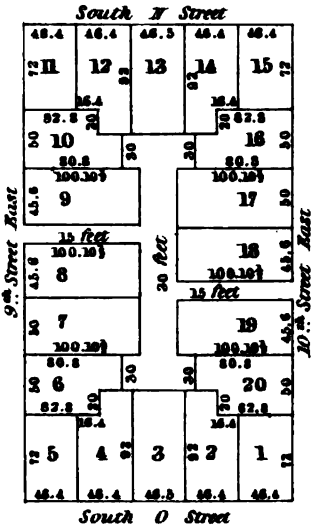

SQUARE N°955

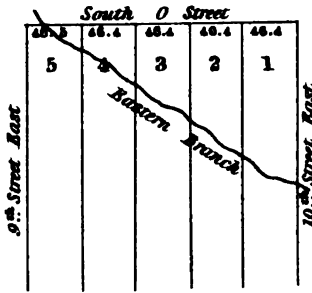

SQUARE N°957

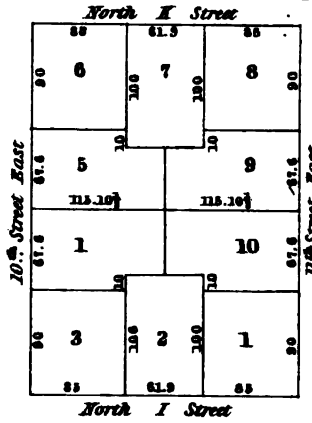

SQUARE N°958

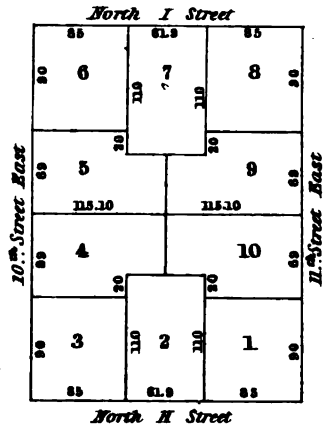

SQUARE N°959

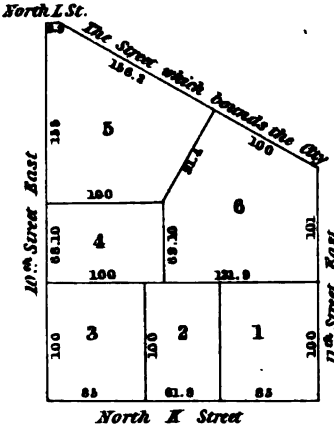

SQUARE N°960

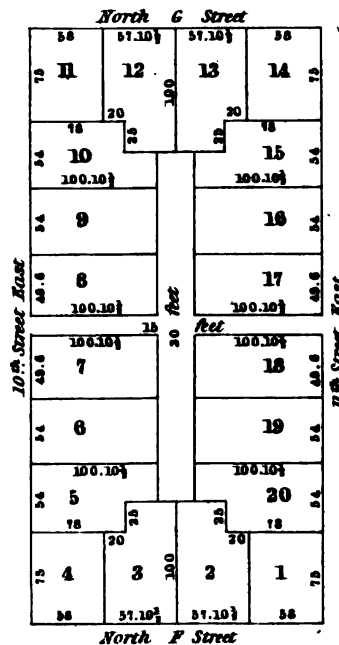

SQUARE N°959

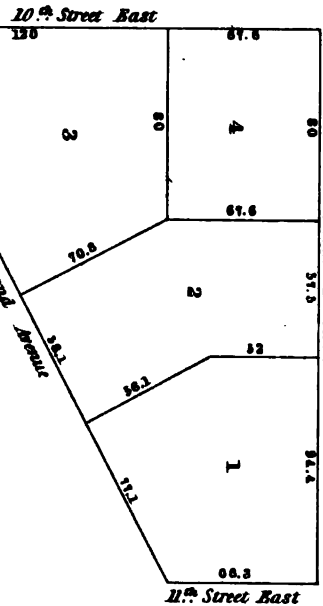
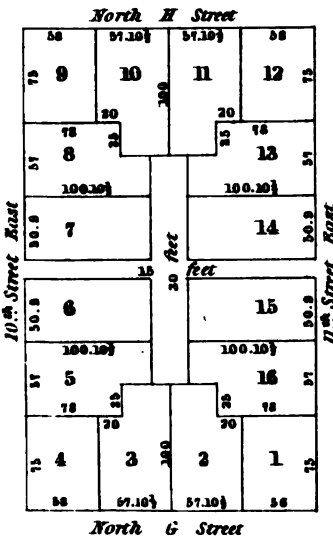

SQUARE N°961



SQUARE N:962

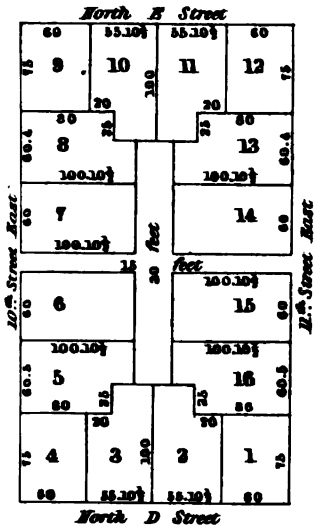

SQUARE N:963

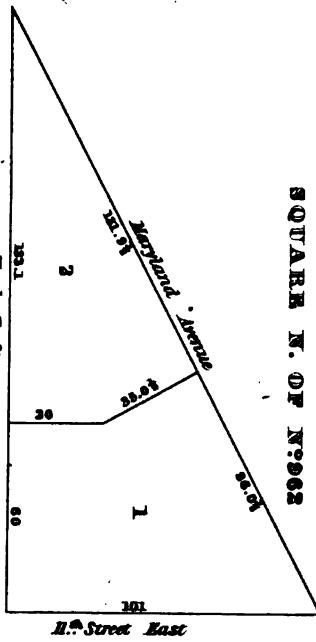
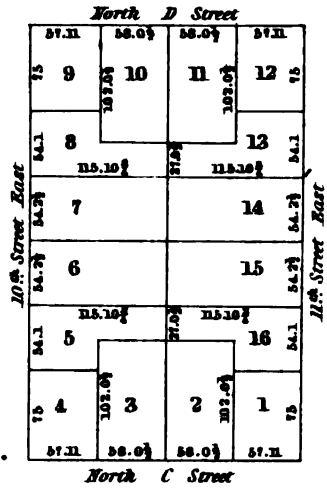

SQUARE N:964

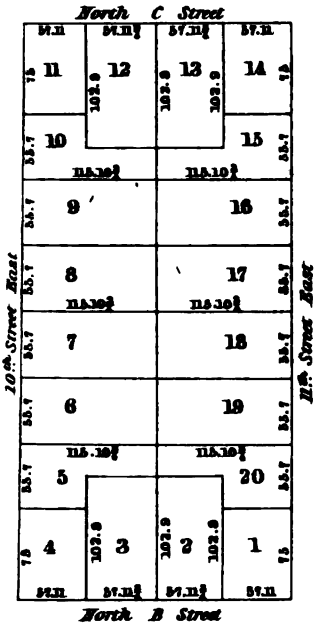

SQUARE N:965

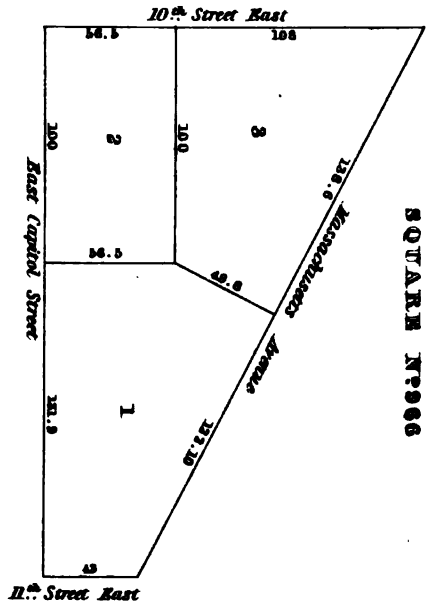
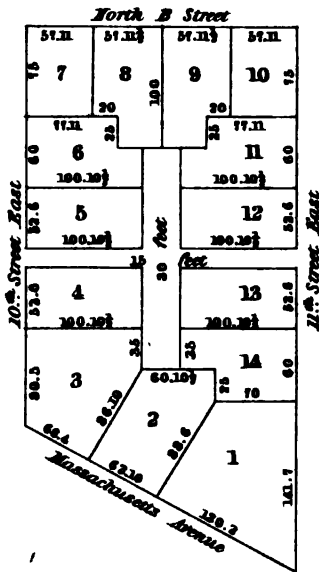

SQUARE N:969

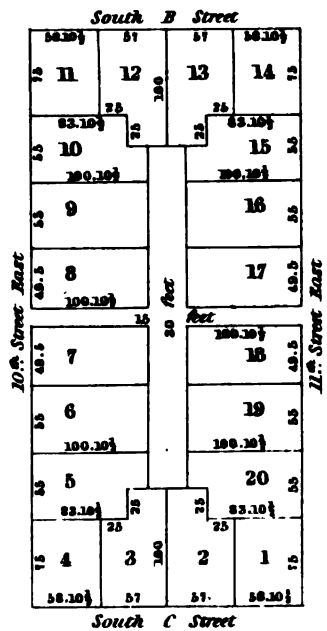

SQUARE N:968

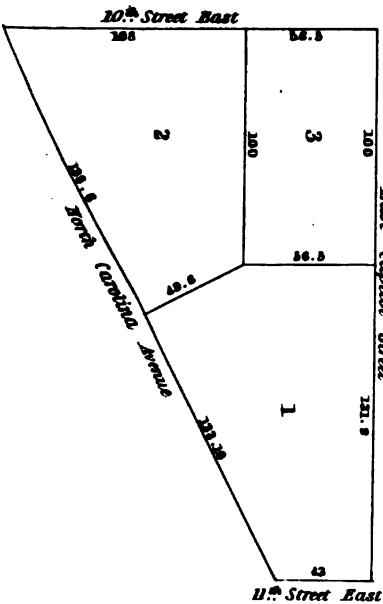
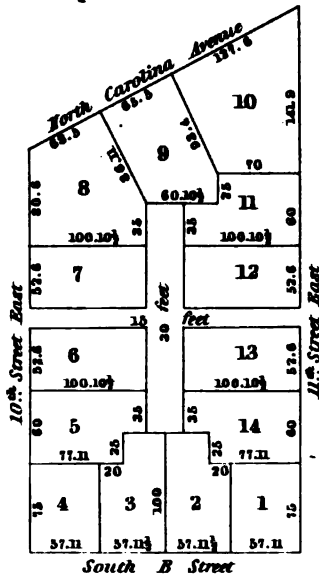



SQUARE N:970

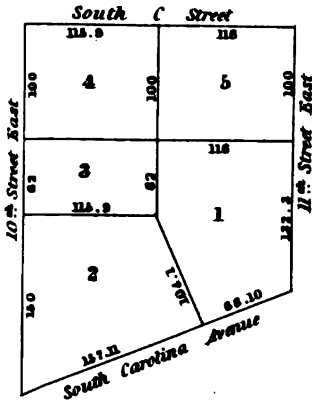

SQUARE N:971

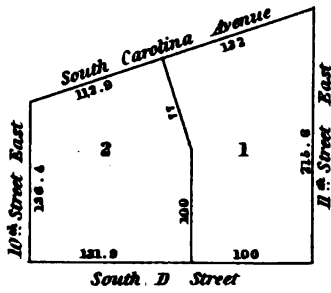

SQUARE N:972

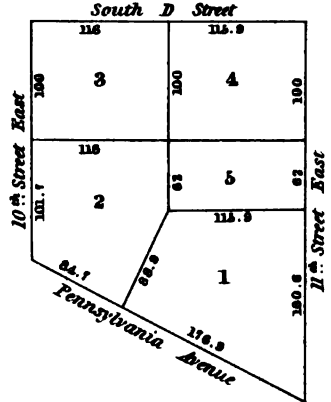

SQUARE N:974

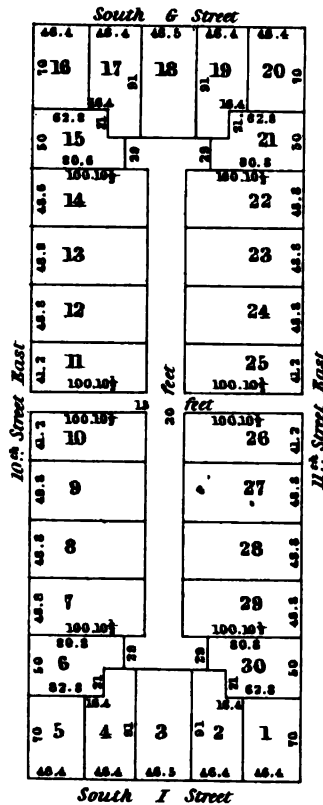

SQUARE N:977

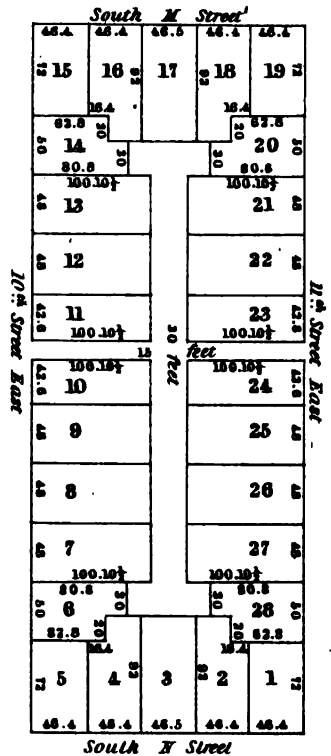

SQUARE N:973

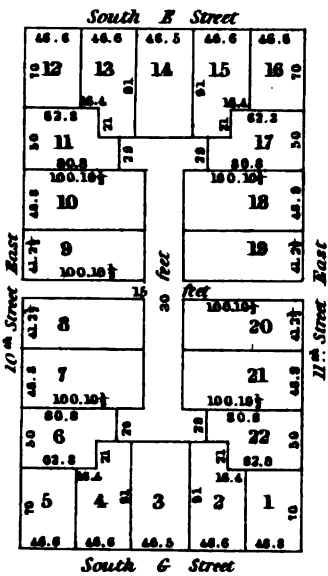

SQUARE N:975

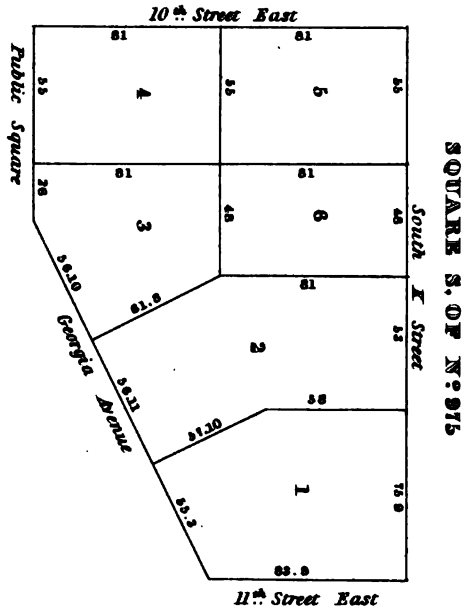
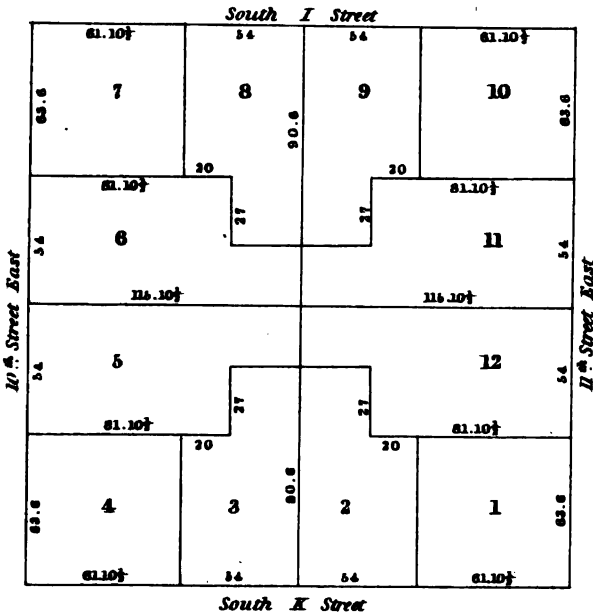





**SQUARE N°916**

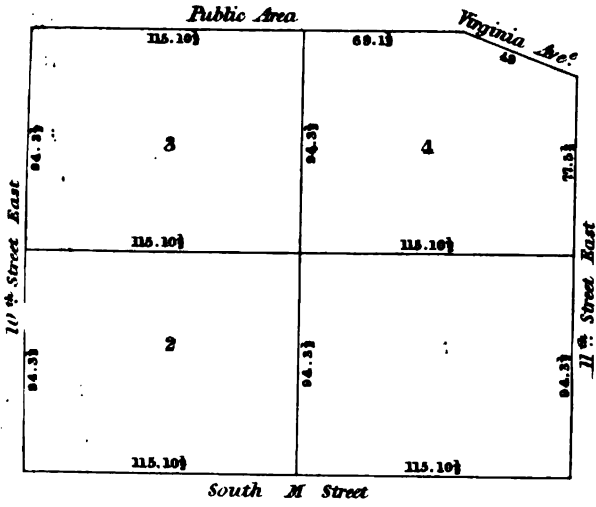

**SQUARE N°918**

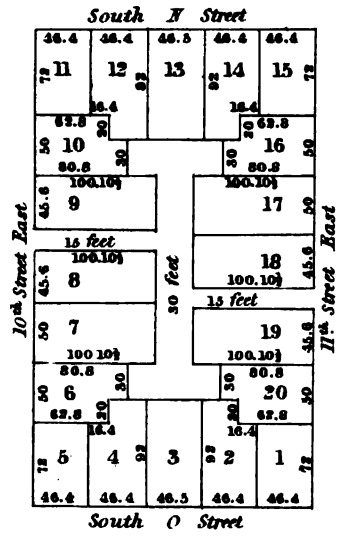

**SQUARE N°919**

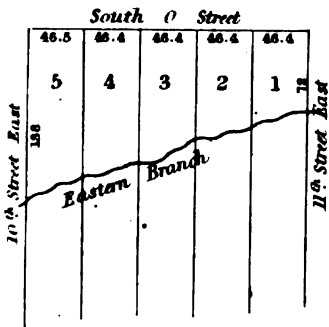

**SQUARE N. OF N°980**

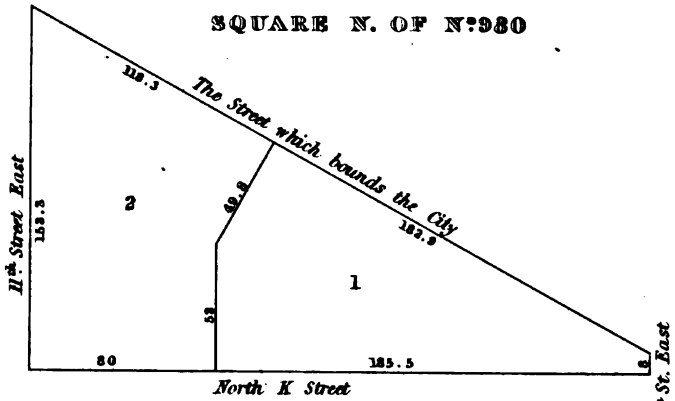

**SQUARE N°980**

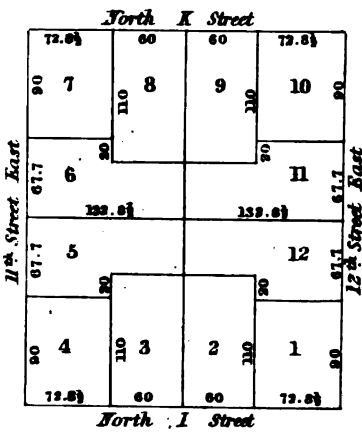

**SQUARE N°981**

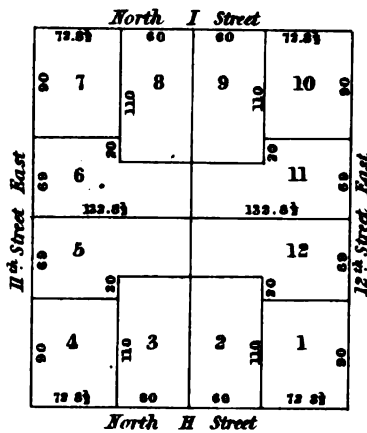

**SQUARE N°982**

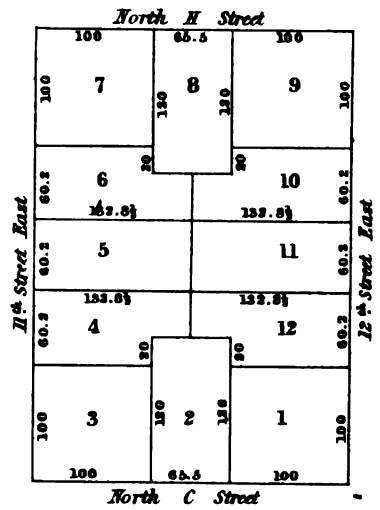

**SQUARE N°983**

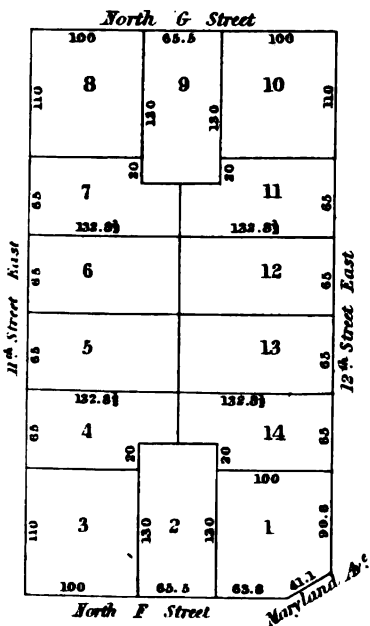

**SQUARE N°985**

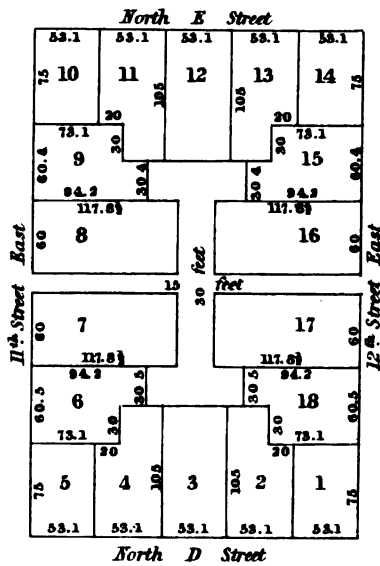

**SQUARE N°984**

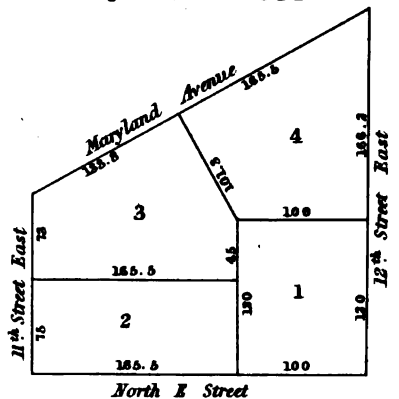



SQUARE N°986

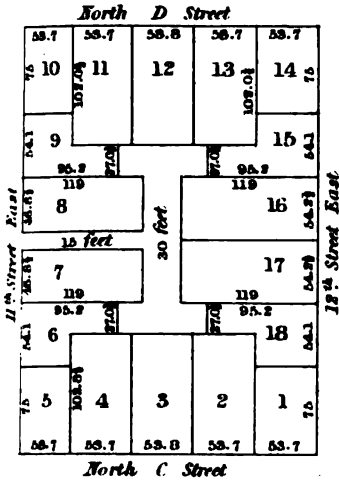

SQUARE N°987

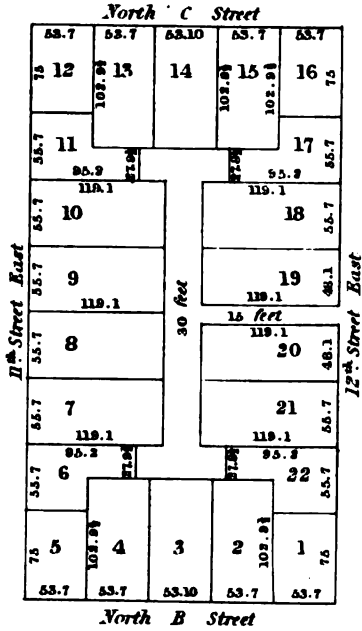

SQUARE N°988

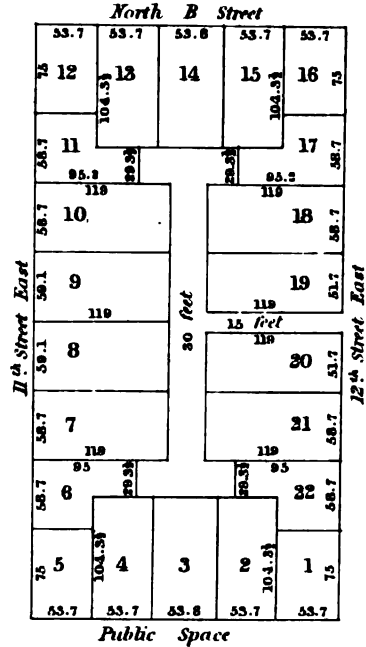

SQUARE N°989

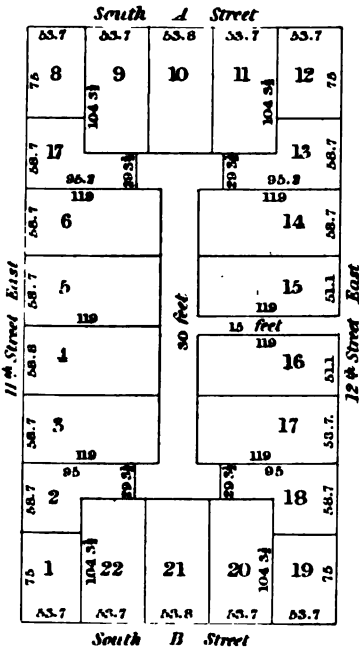

SQUARE N°990

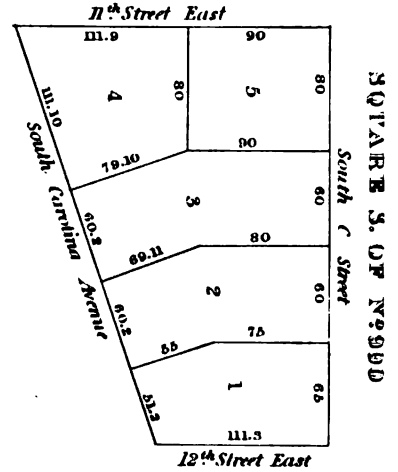
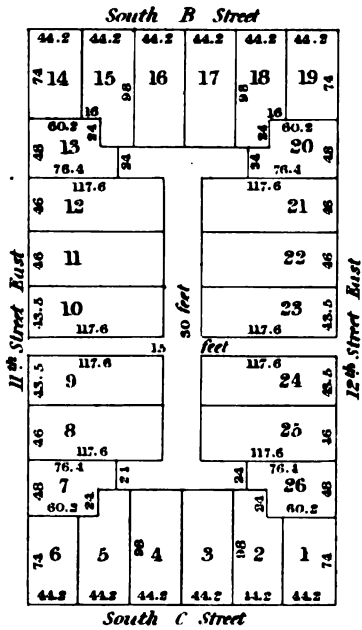

SQUARE N°991

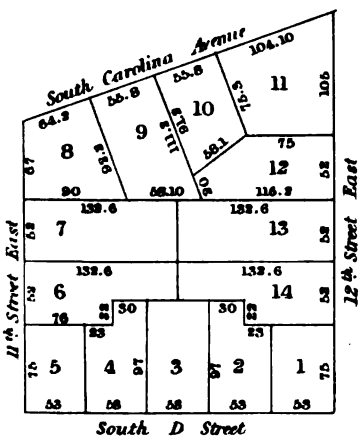

SQUARE N°992

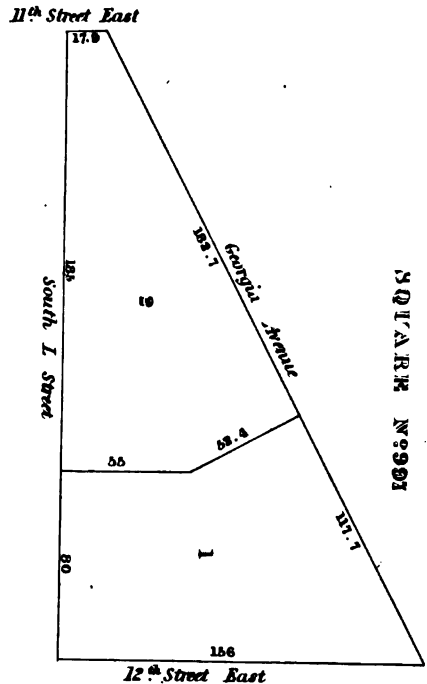
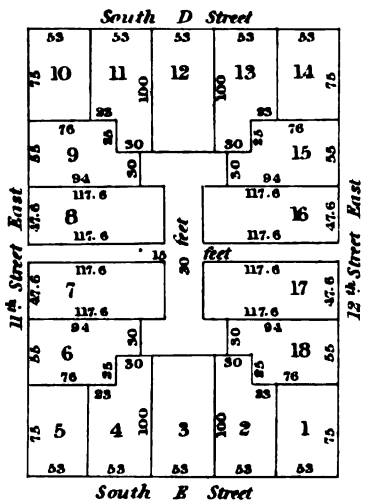

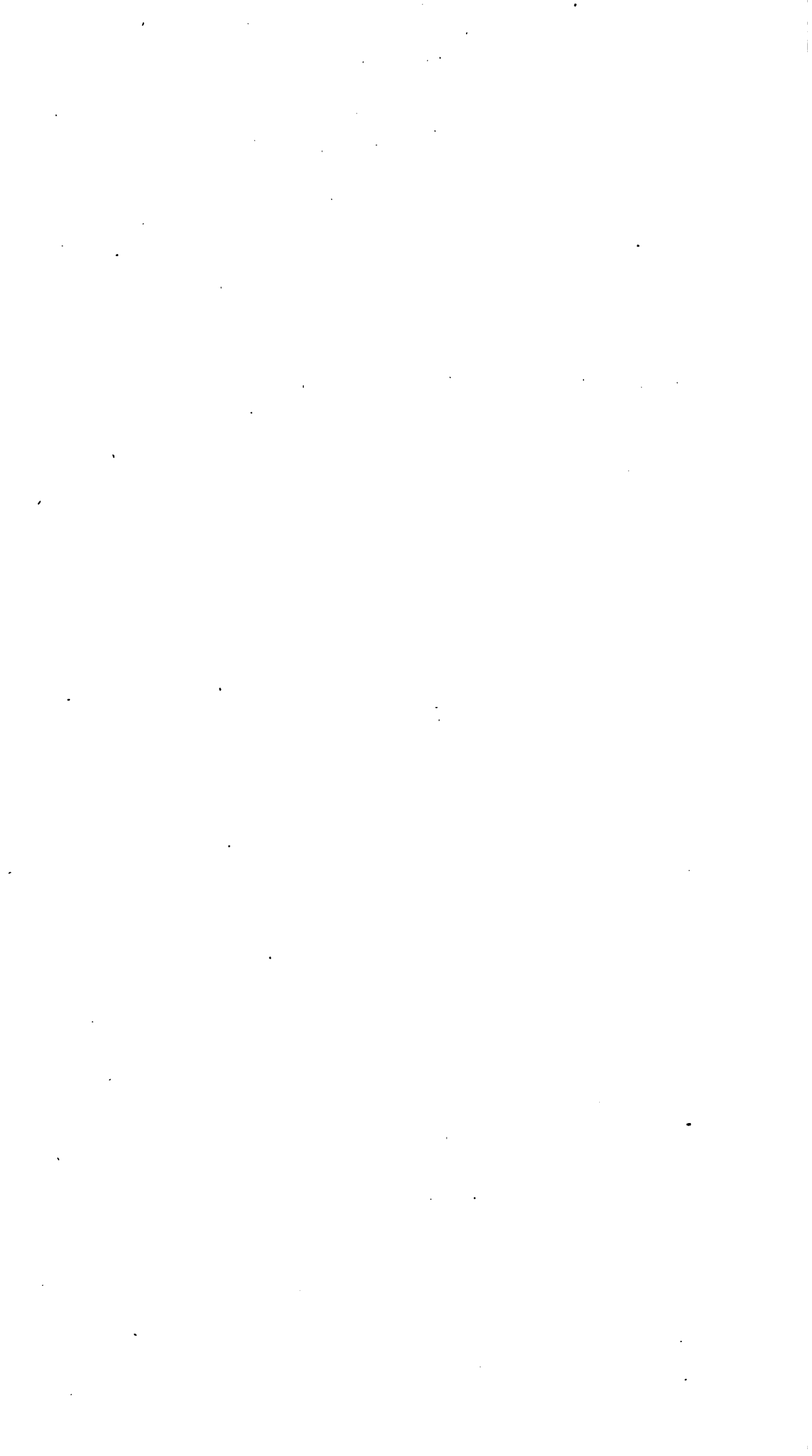

SQUARE N:999

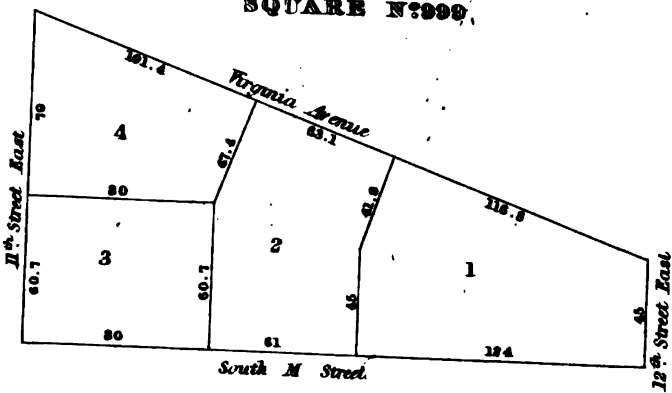

SQUARE N:1000

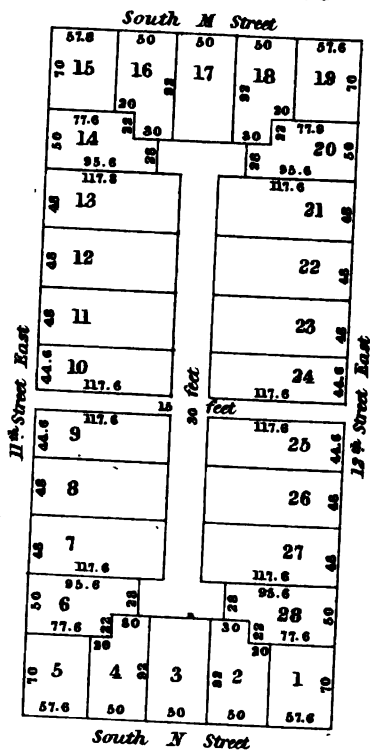

SQUARE N:1002

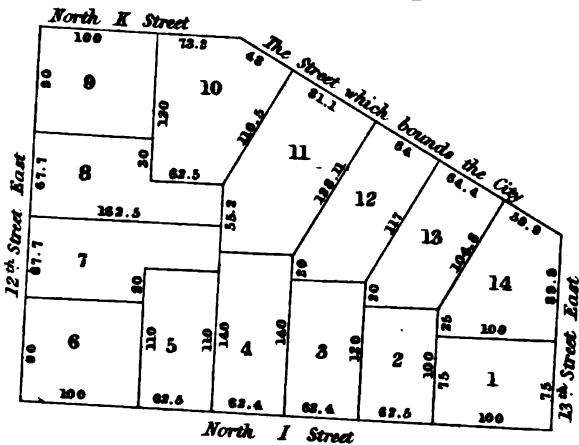

SQUARE N:1001

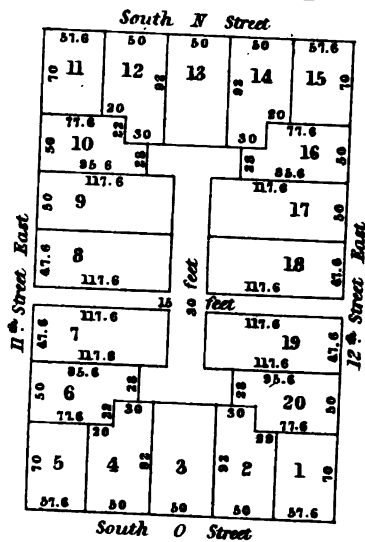

SQUARE N:1003

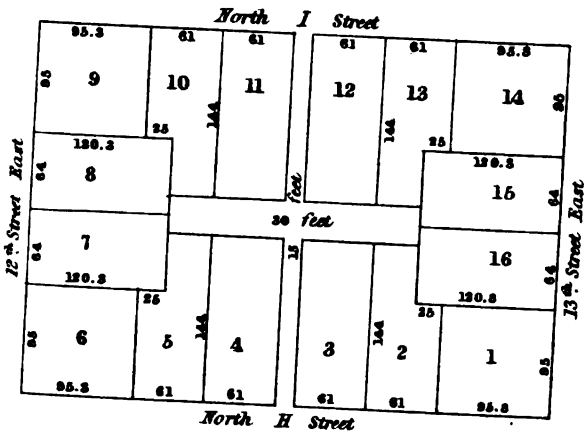

SQUARE N:1005

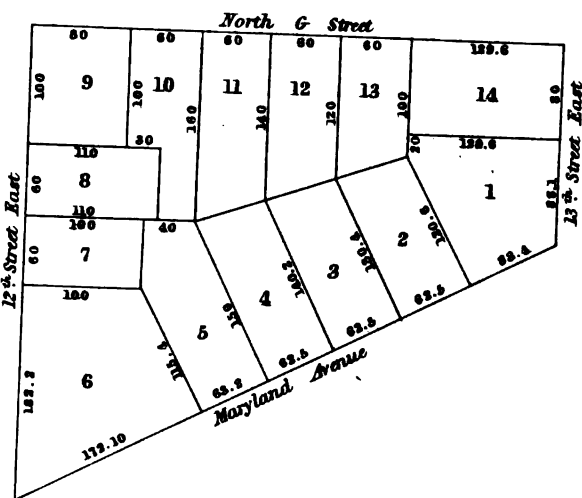

SQUARE N:1004

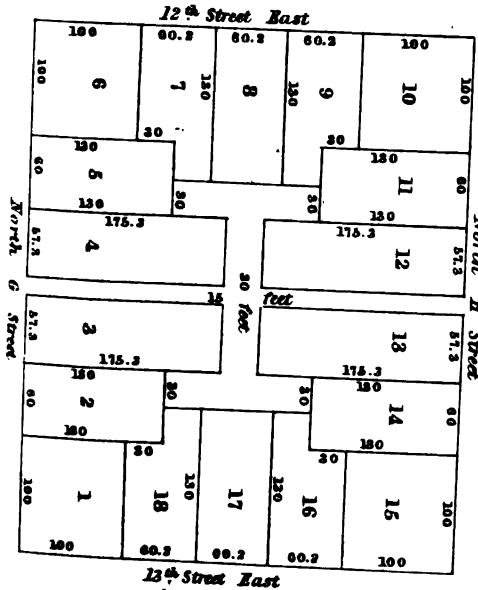



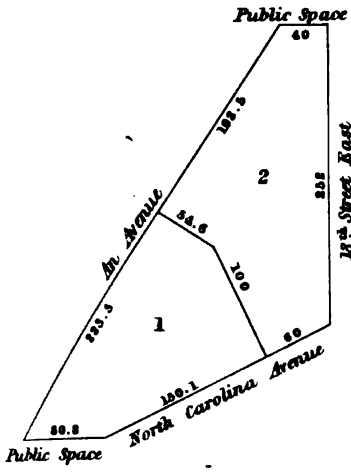

SQUARE N°1007

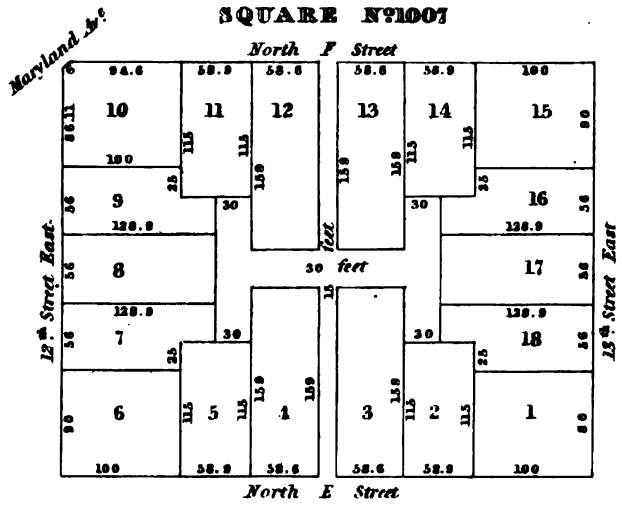

SQUARE N°1008

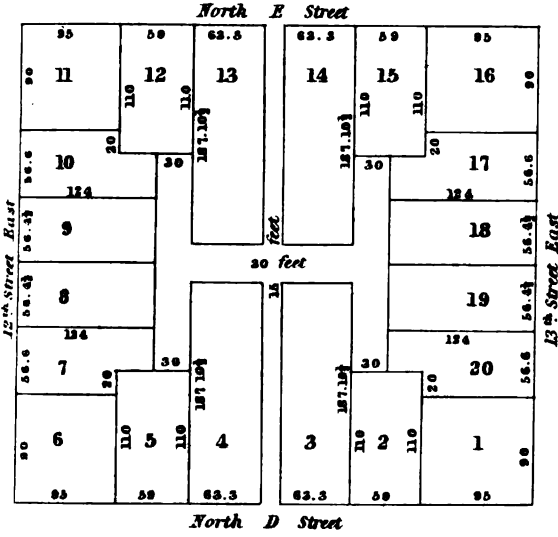

SQUARE N°1009

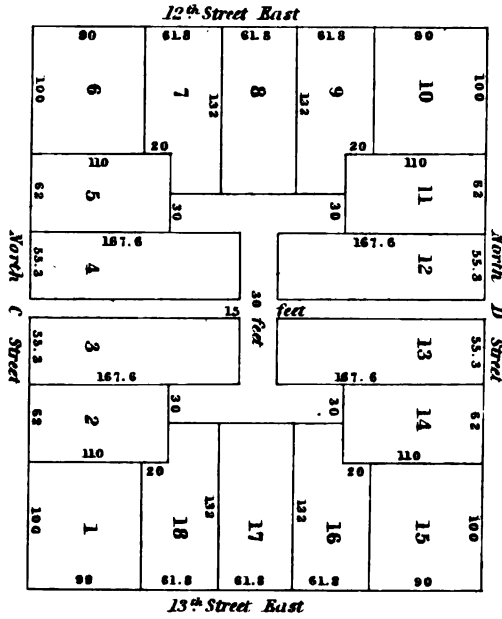

SQUARE N°1010

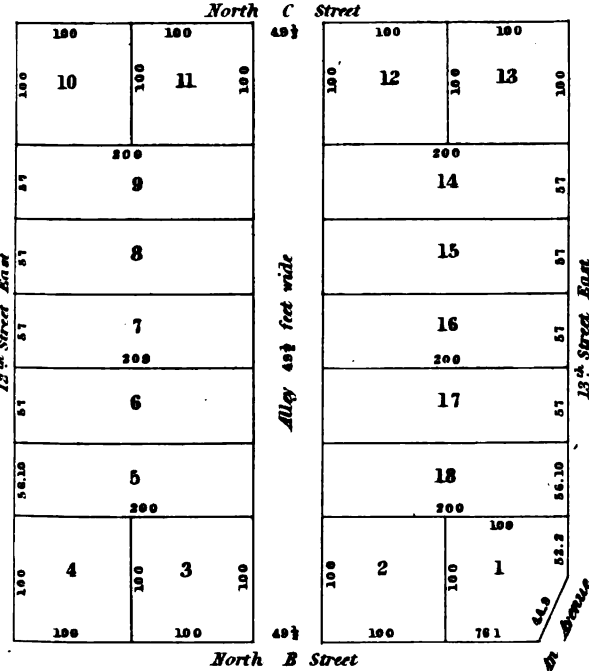

SQUARE N°1011

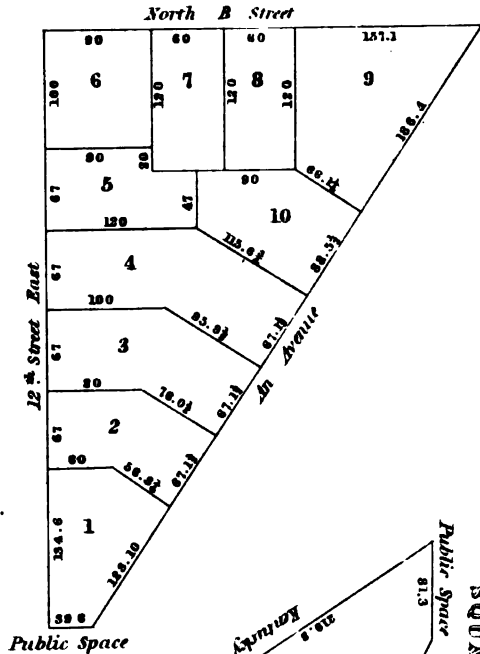

SQUARE N°1006

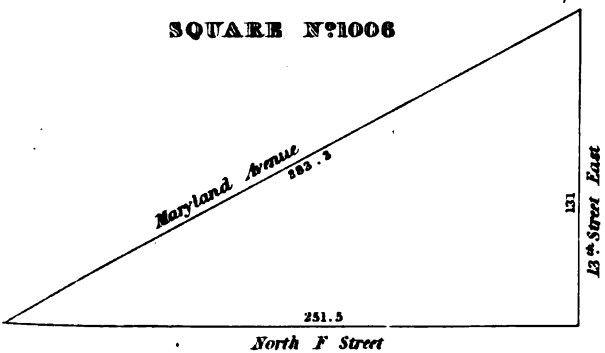

SQUARE N°1013

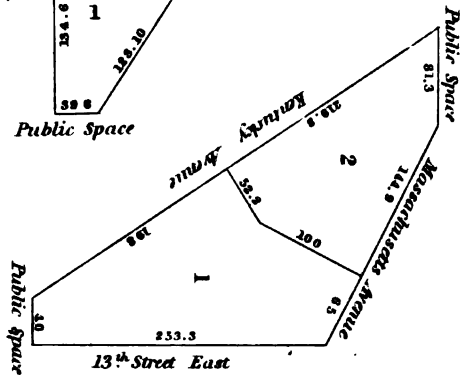





**SQUARE N°1012**



**SQUARE N°1007**

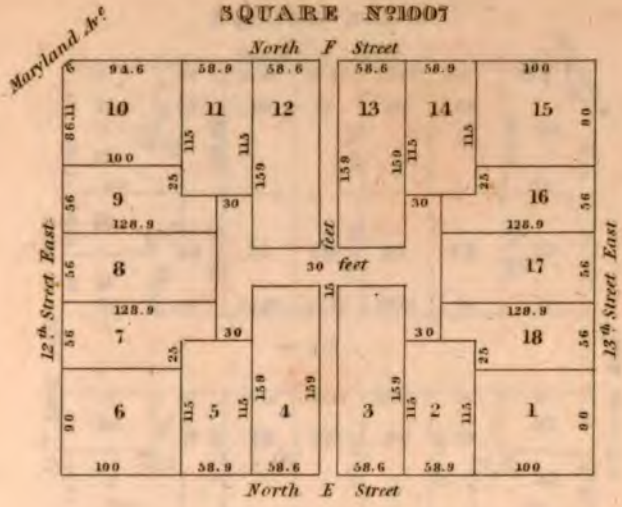

**SQUARE N°1008**

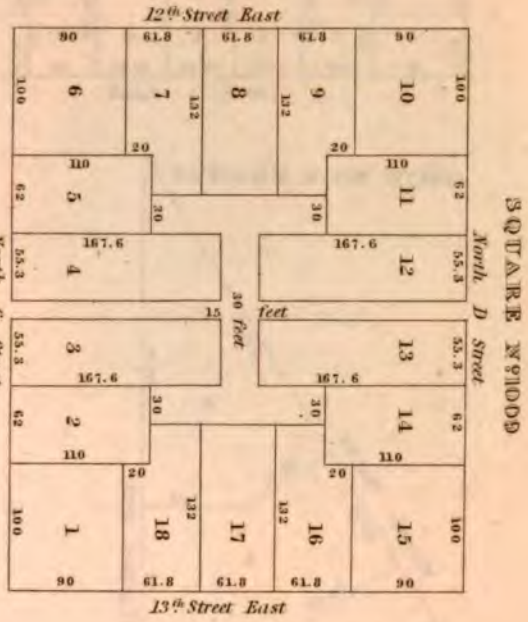
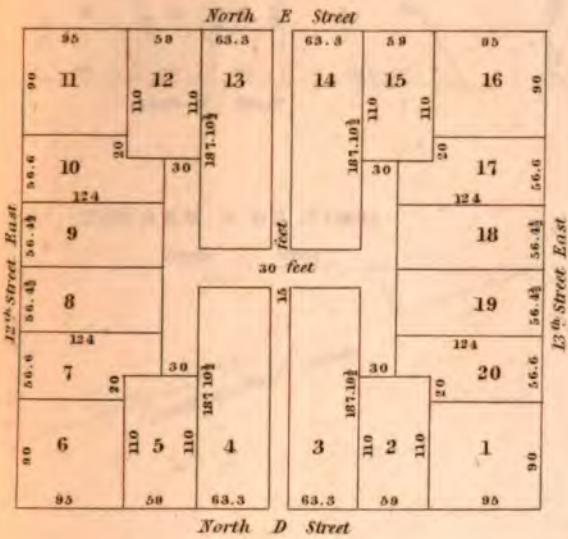

**SQUARE N°1010**



**SQUARE N°1011**



**SQUARE N°1006**



**SQUARE N°1013**



SQUARE N°1012

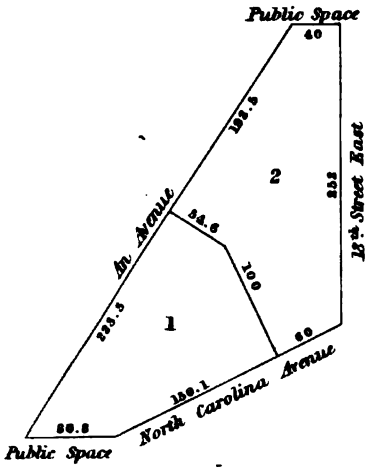

SQUARE N°1007

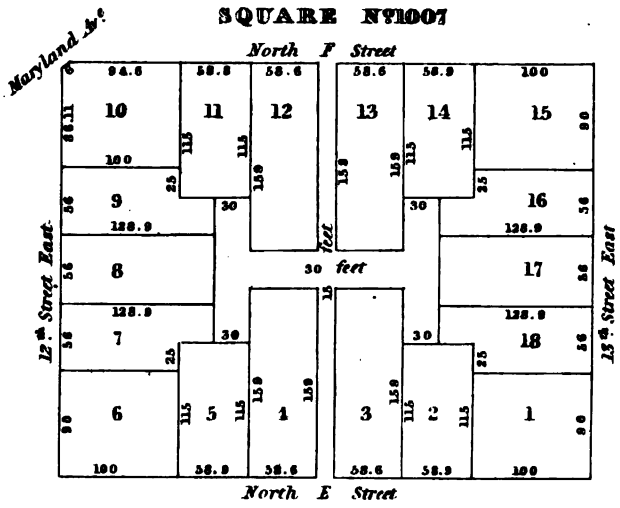

SQUARE N°1008

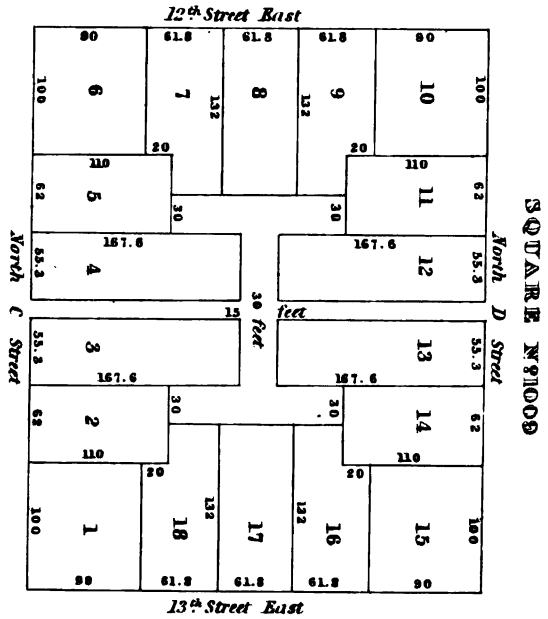
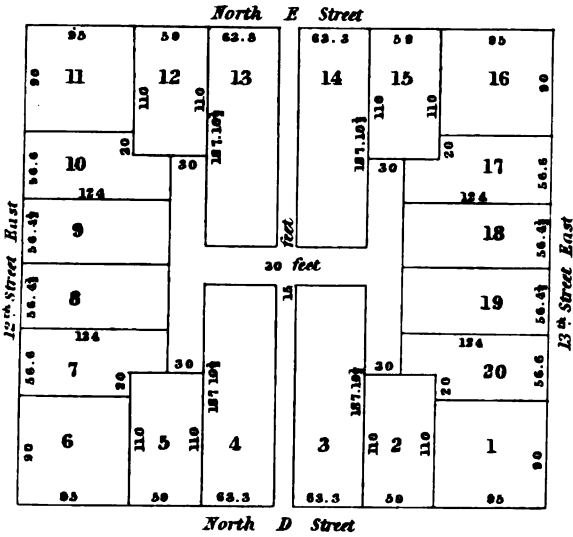

SQUARE N°1010

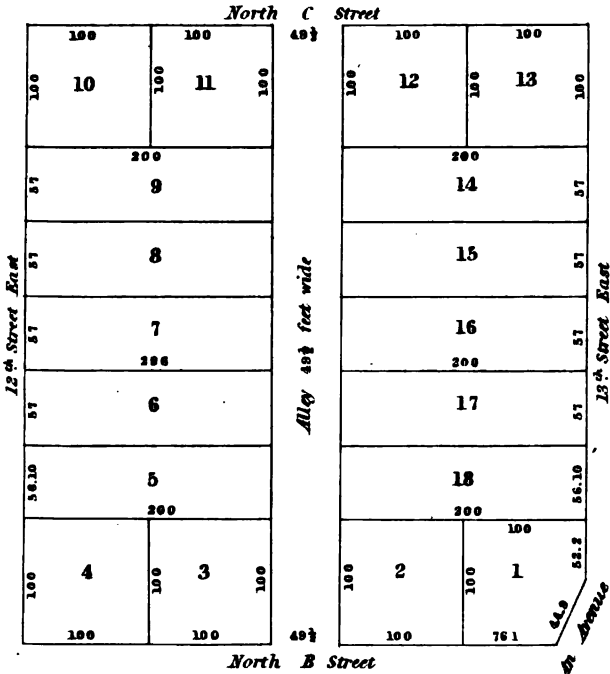

SQUARE N°1011

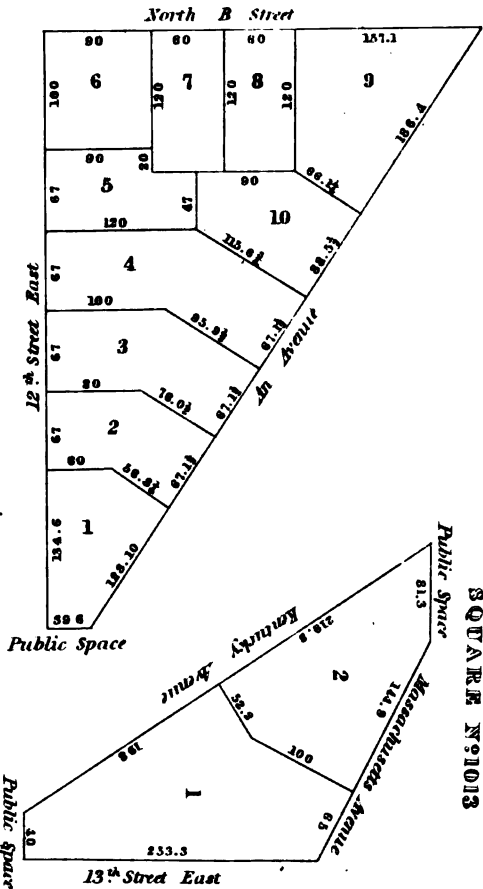

SQUARE N°1006

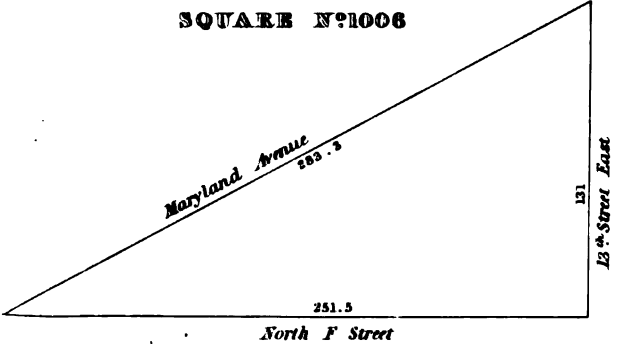

SQUARE N°1013

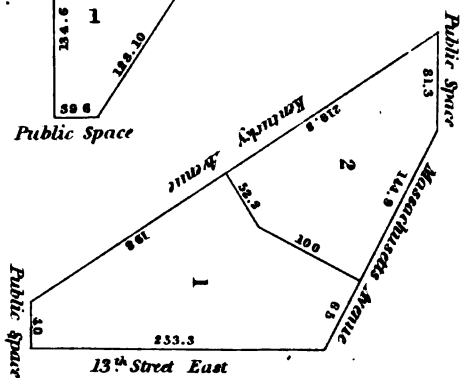

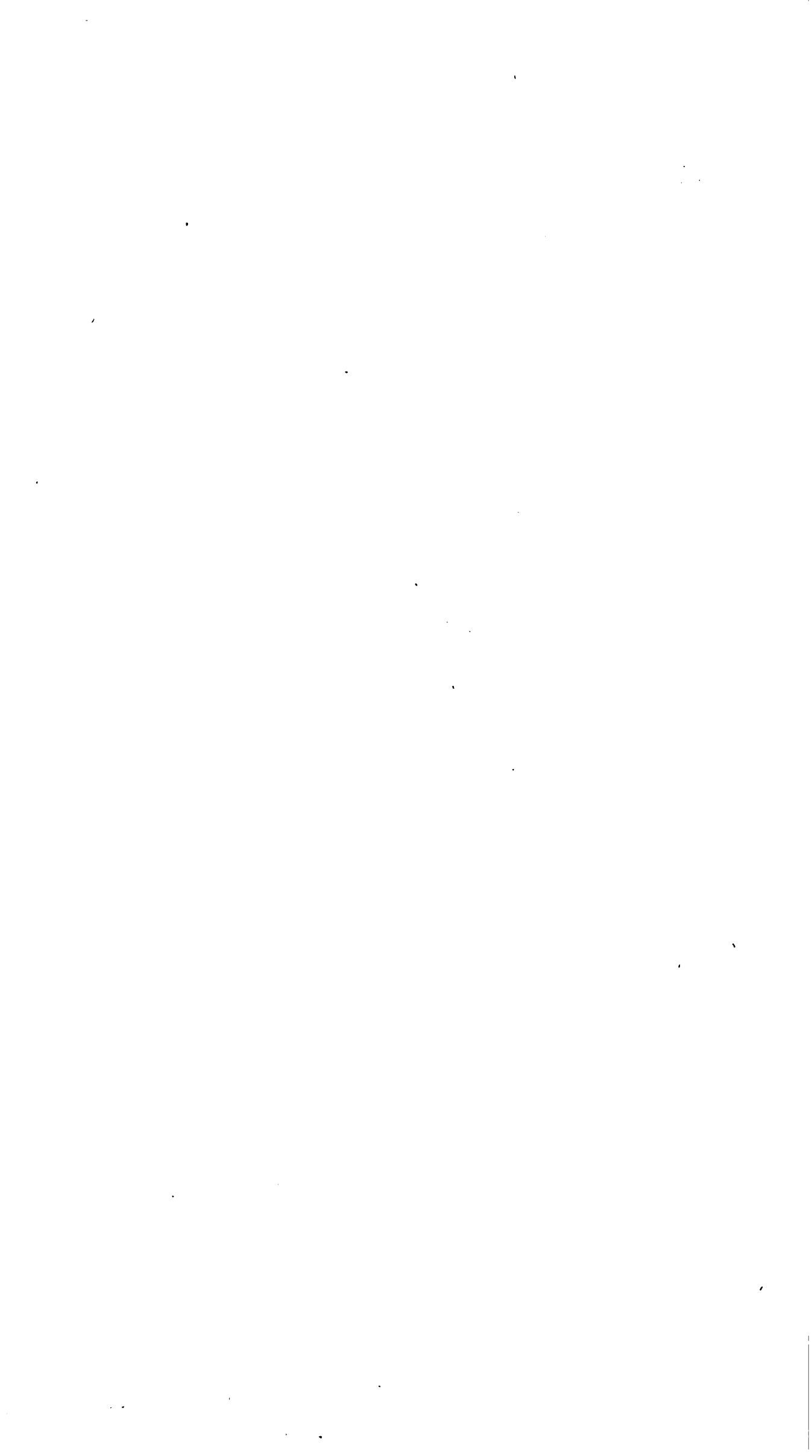

Public Space

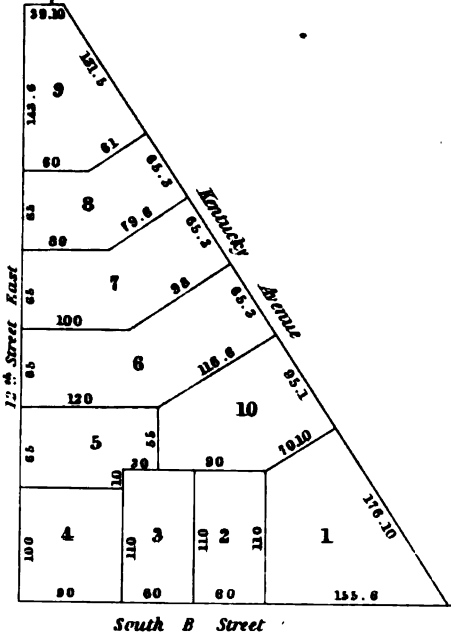

SQUARE N°1015

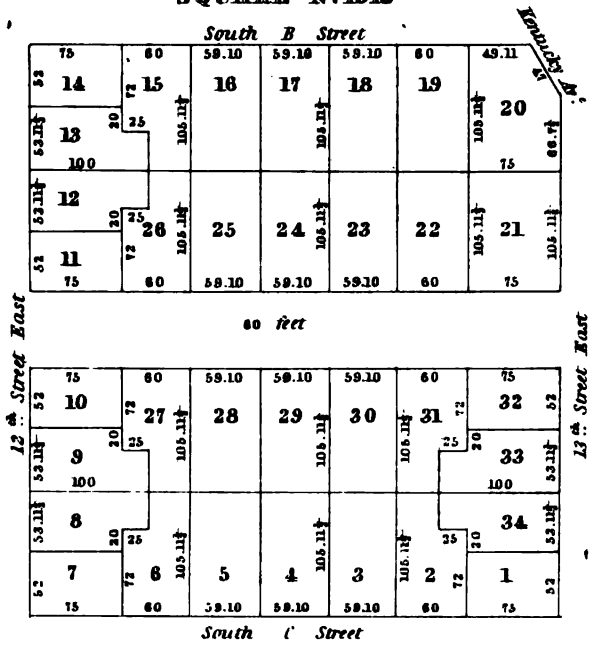

SQUARE S. OF N°1016

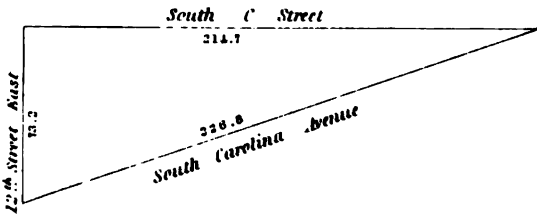

SQUARE E. OF N°1016

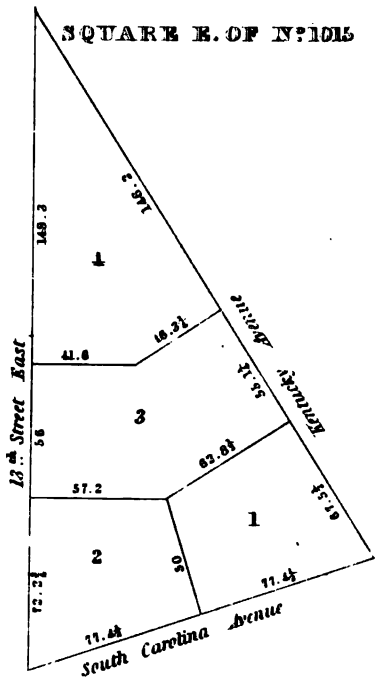

SQUARE N°1017

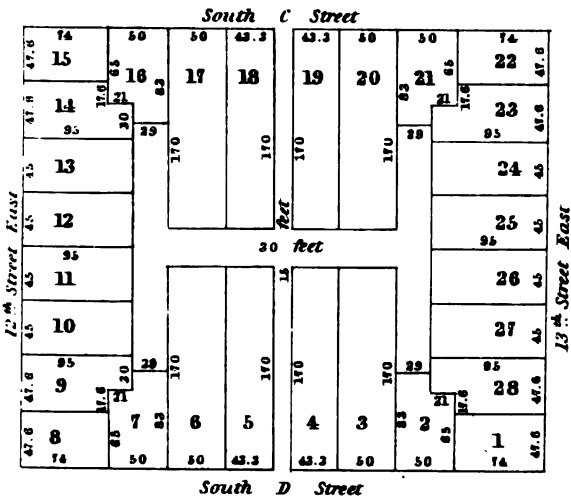

SQUARE N°1018

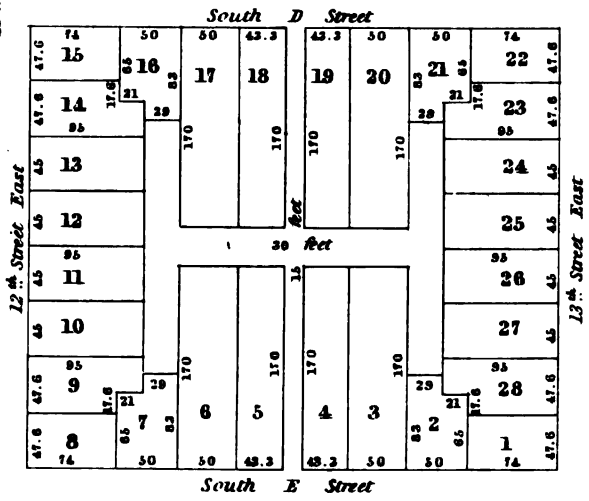

SQUARE N°1019

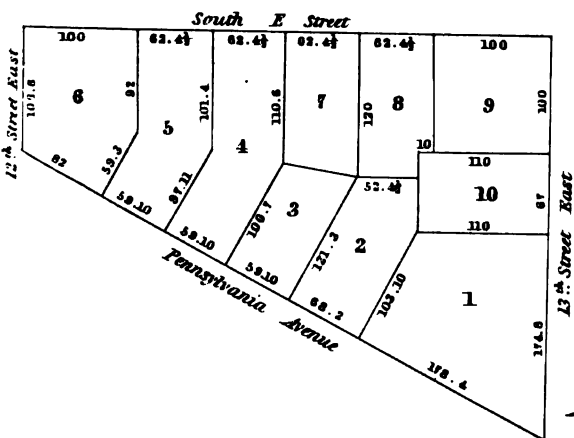

SQUARE N. OF N°1017

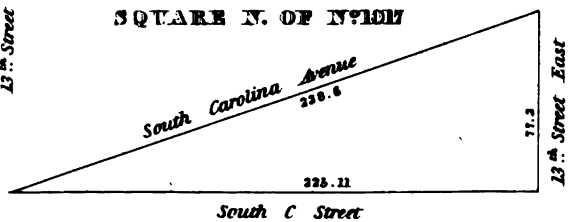



SQUARE S. OF N°1019

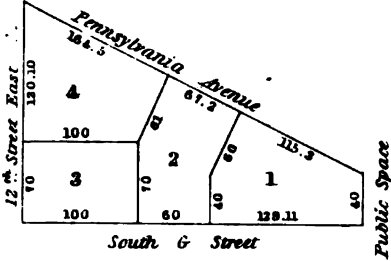

SQUARE N°1020

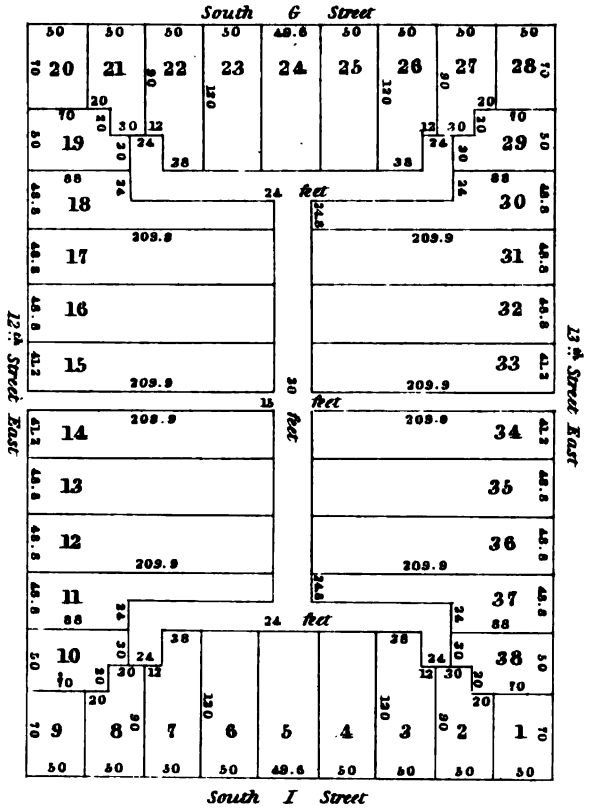

SQUARE N°1022

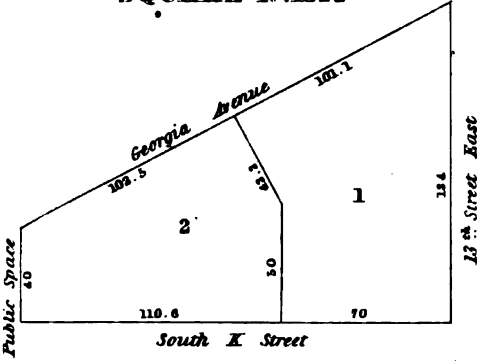

SQUARE N°1021

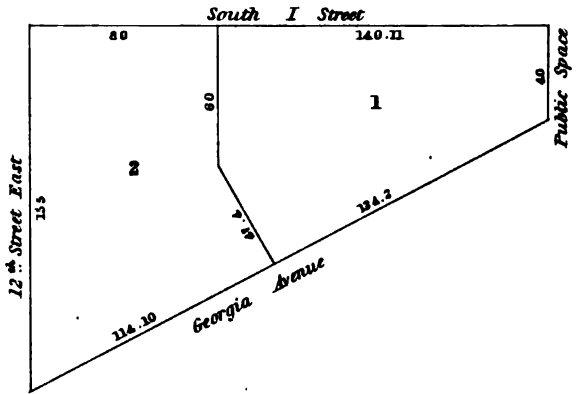

SQUARE N°1023

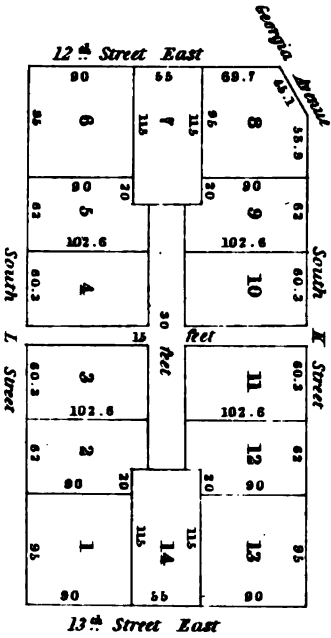

SQUARE E. OF N°1025

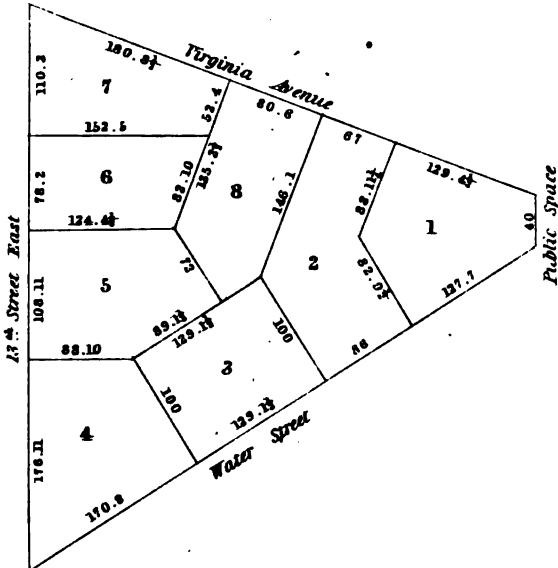

SQUARE N°1024

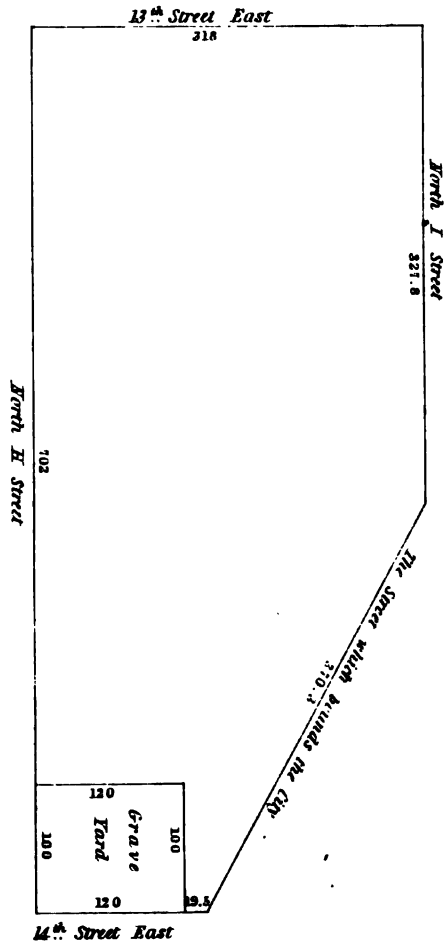





SQUARE N. OF N:1026

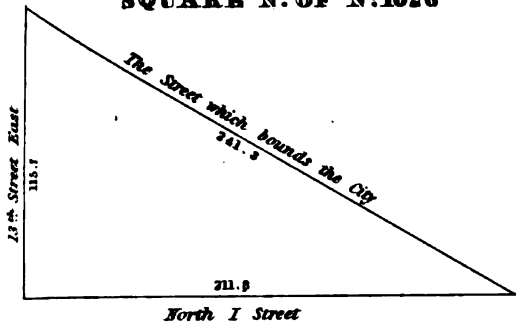

SQUARE S. OF N:1027

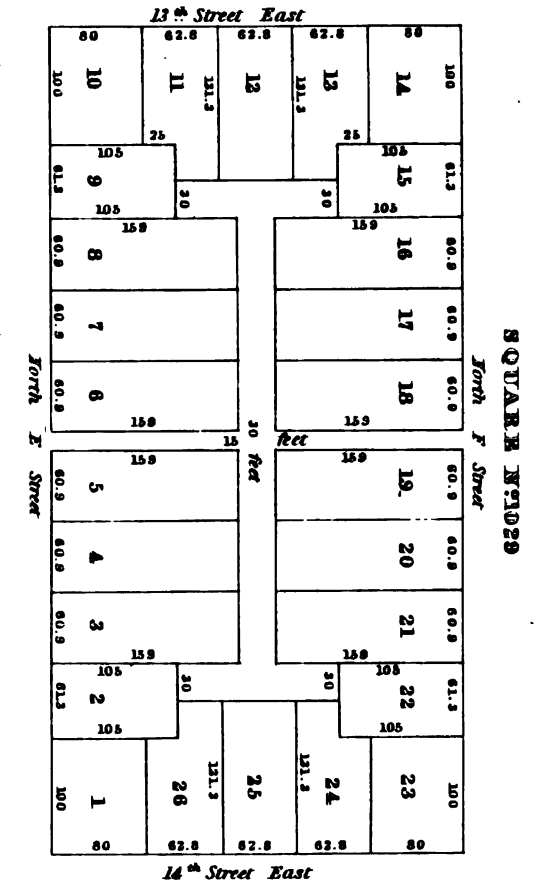
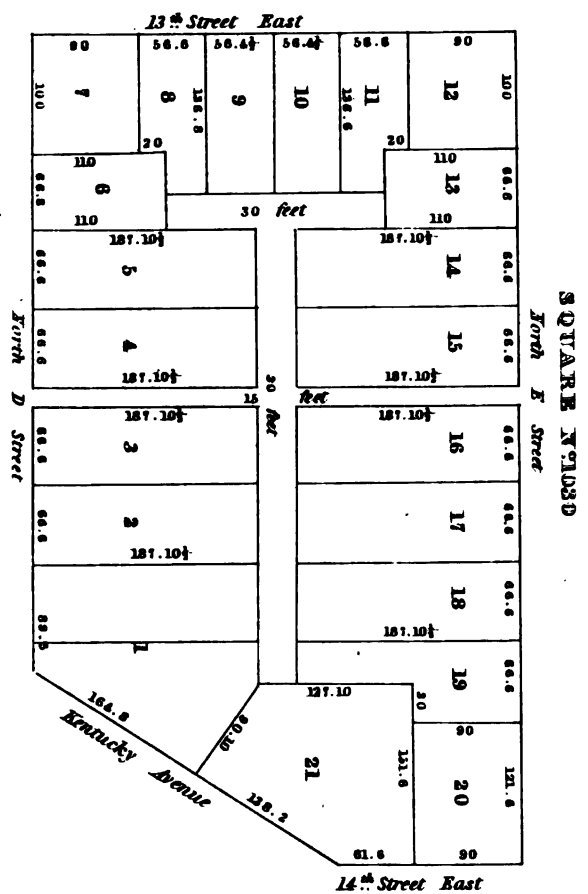
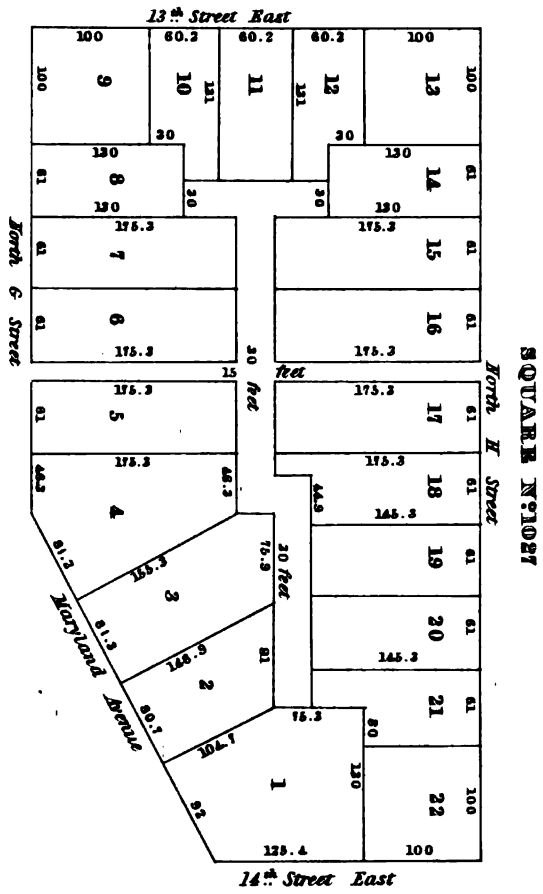
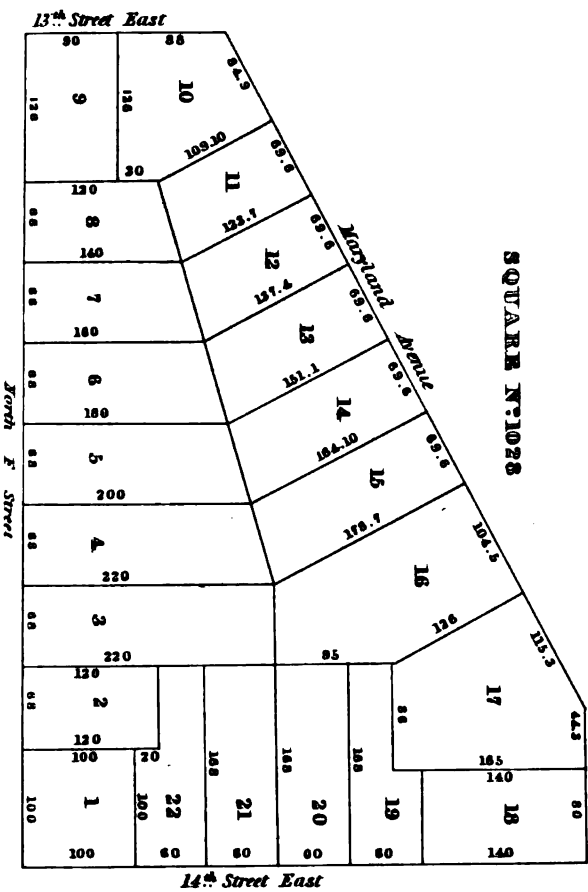
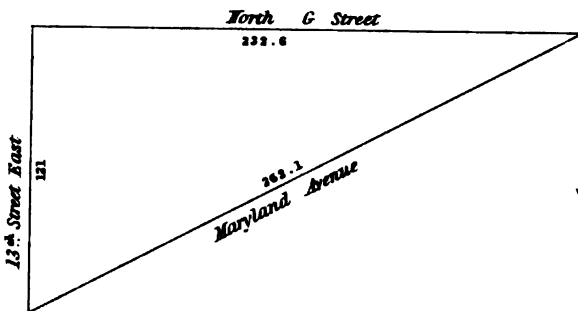

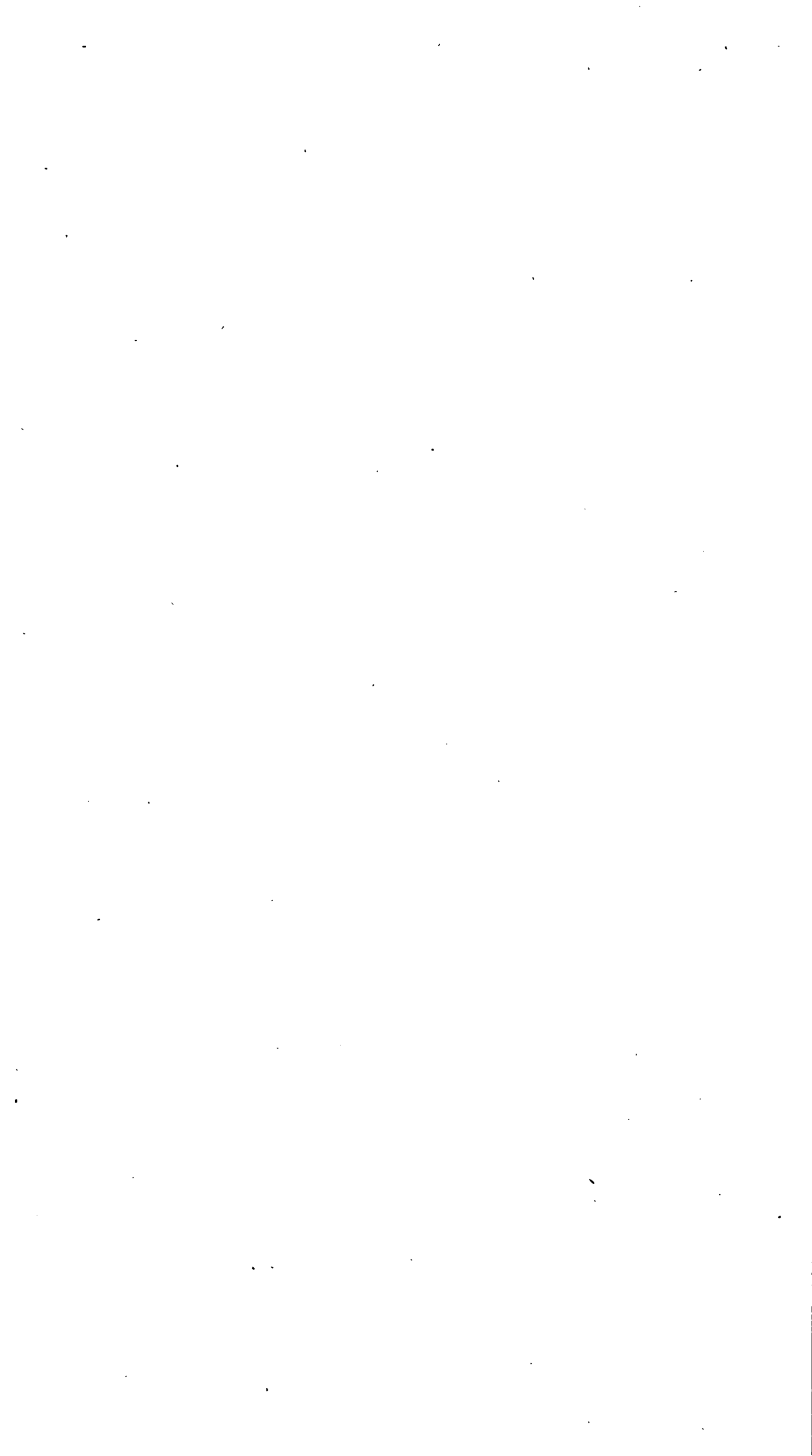

SQUARE N°1031

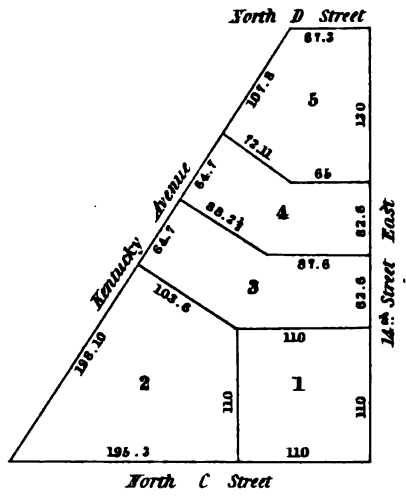
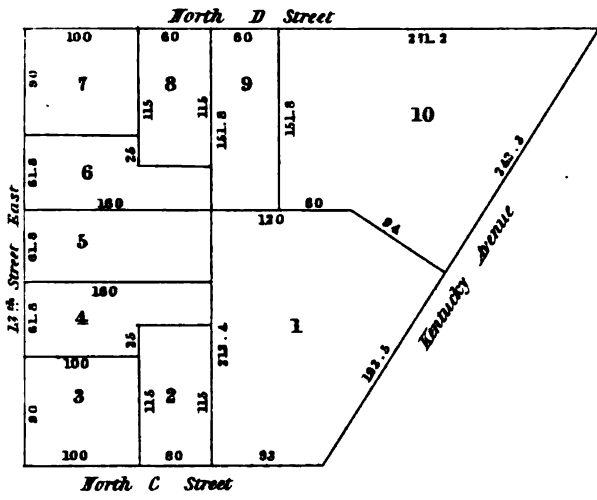

SQUARE N°1033

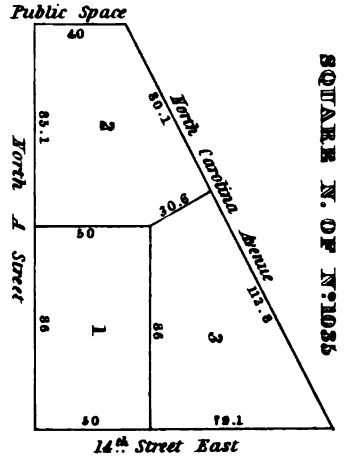
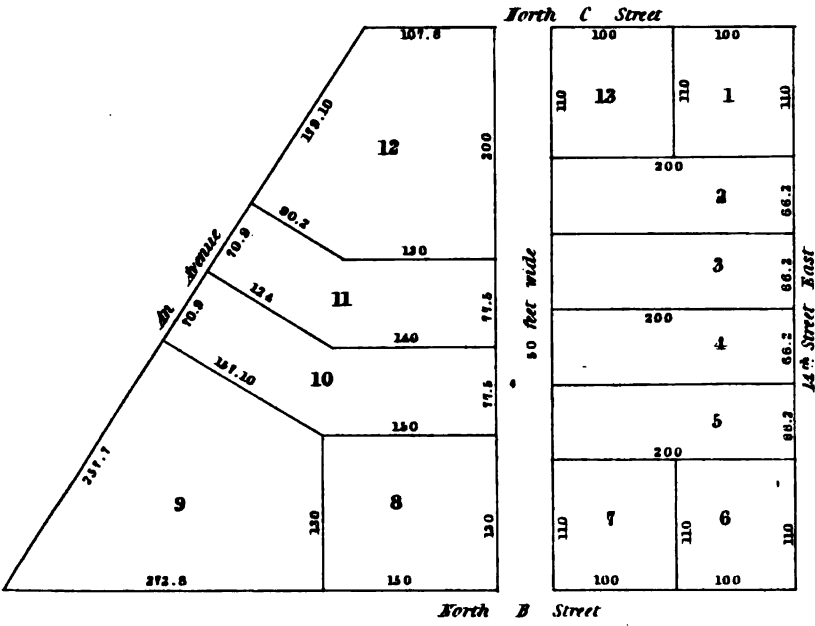

SQUARE N. OF N°1035

SQUARE N.W. OF N°1033

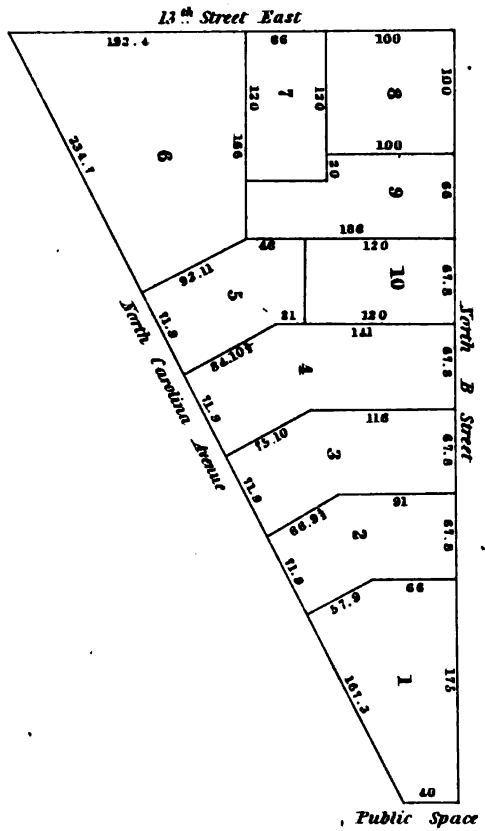
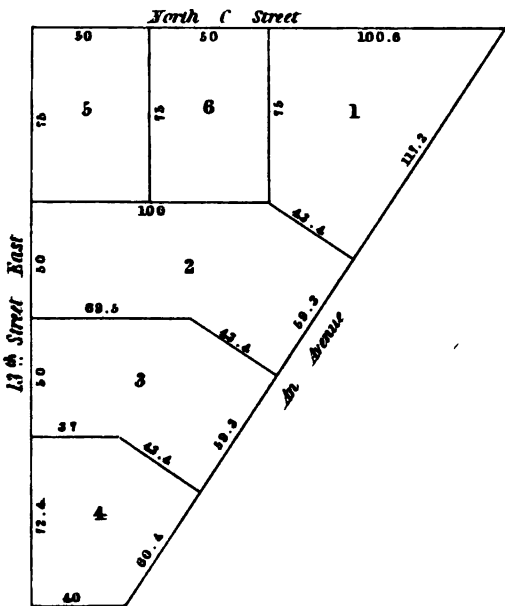

SQUARE N°1034



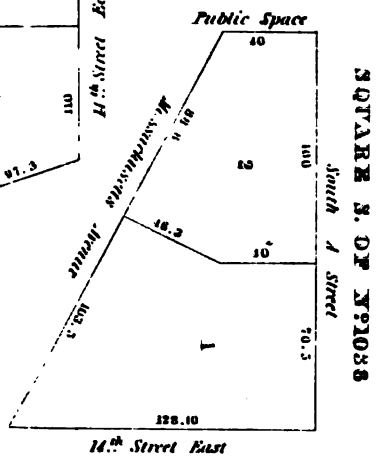
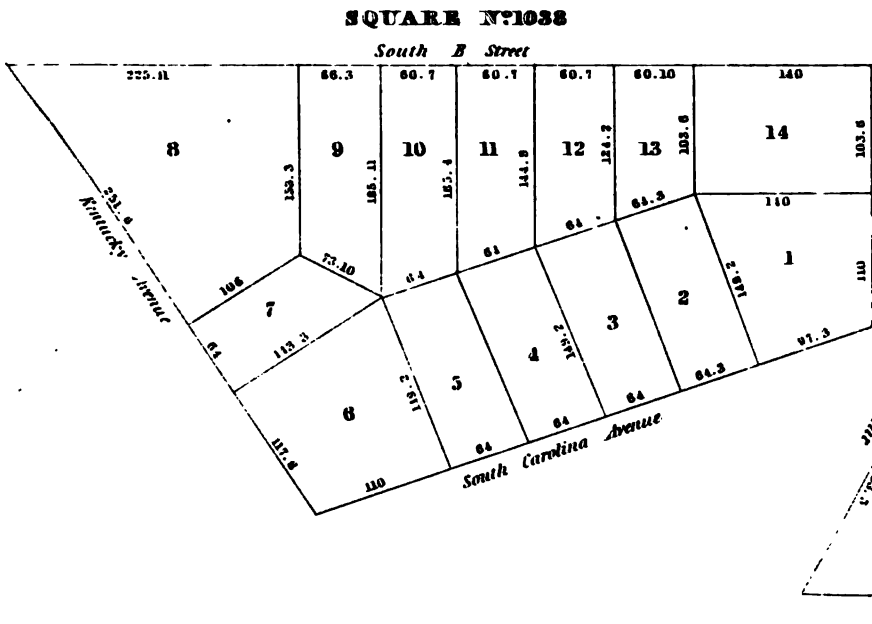
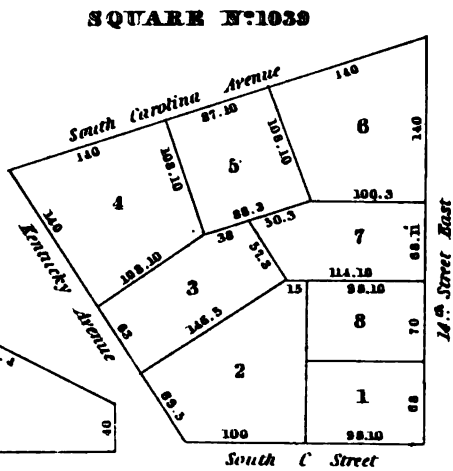
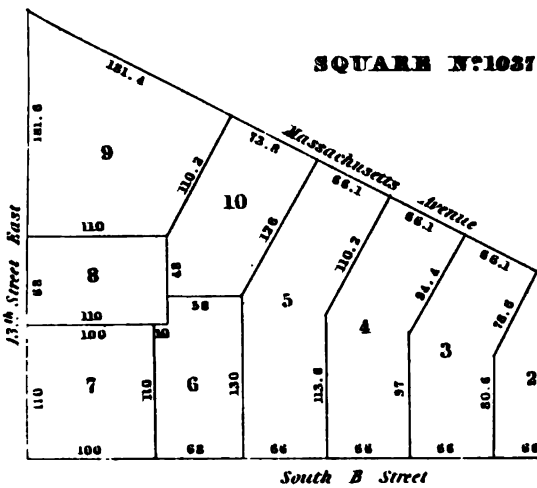
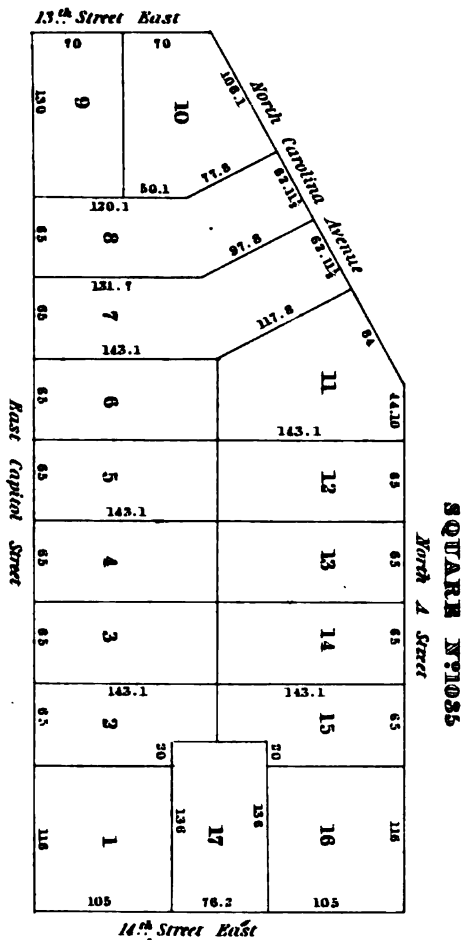
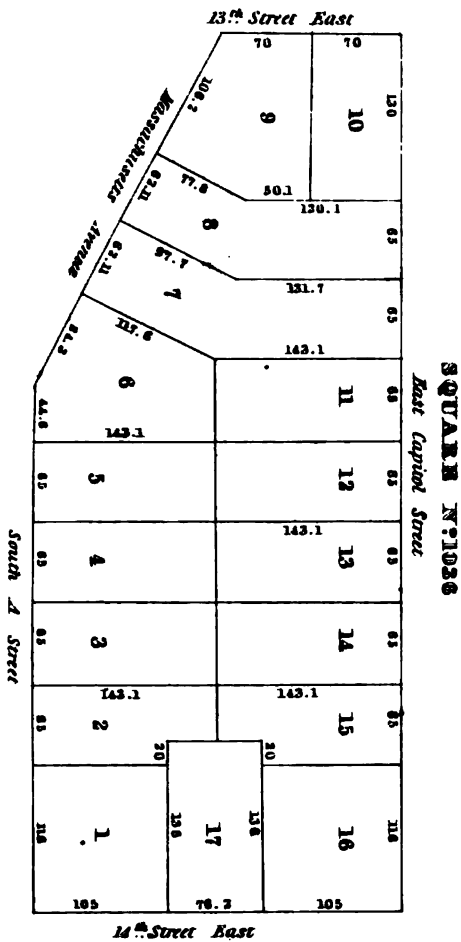



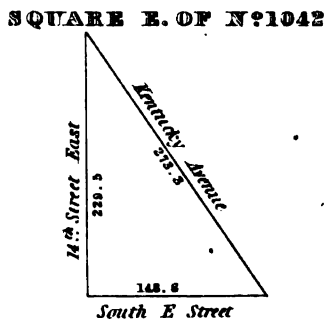
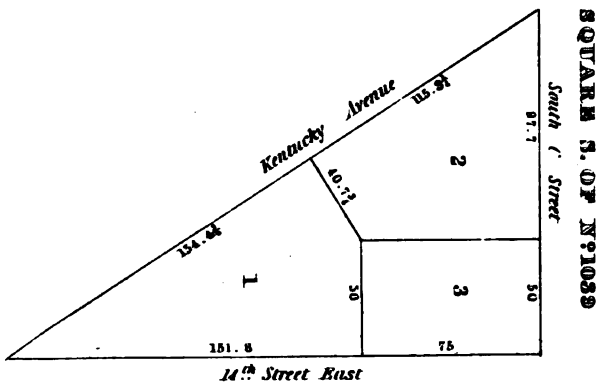
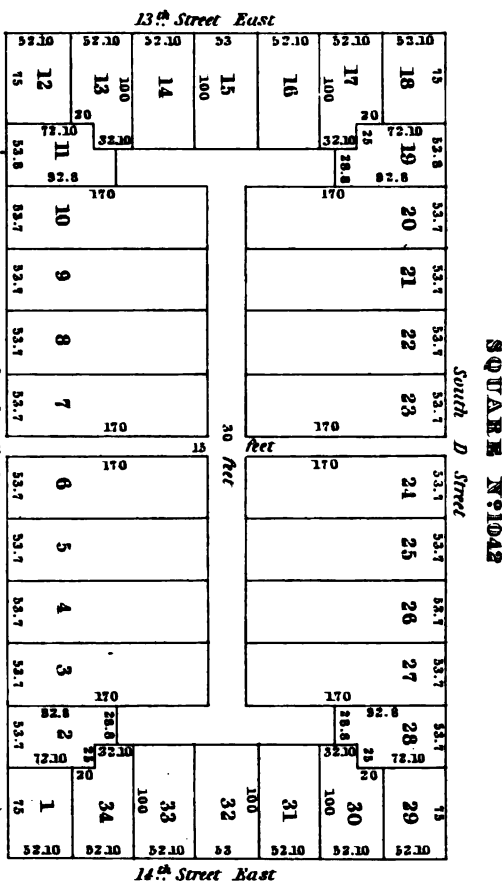
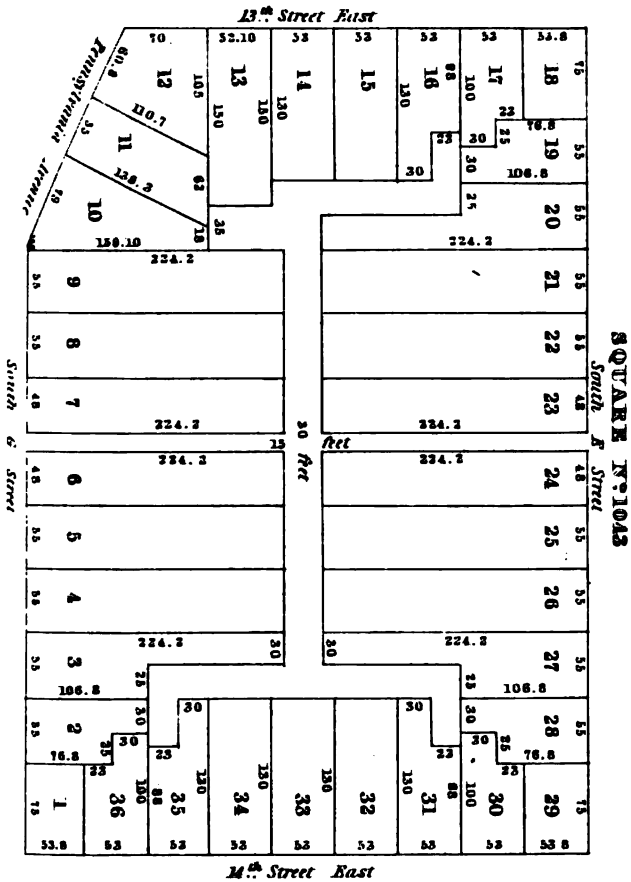
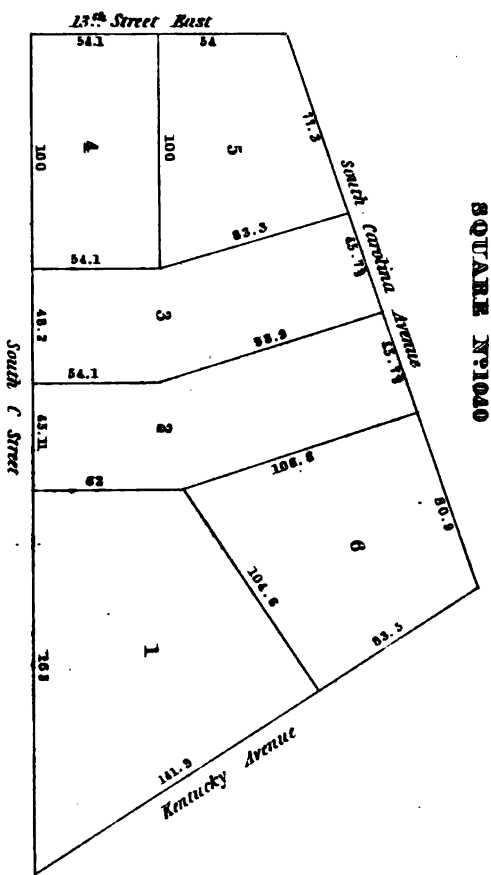
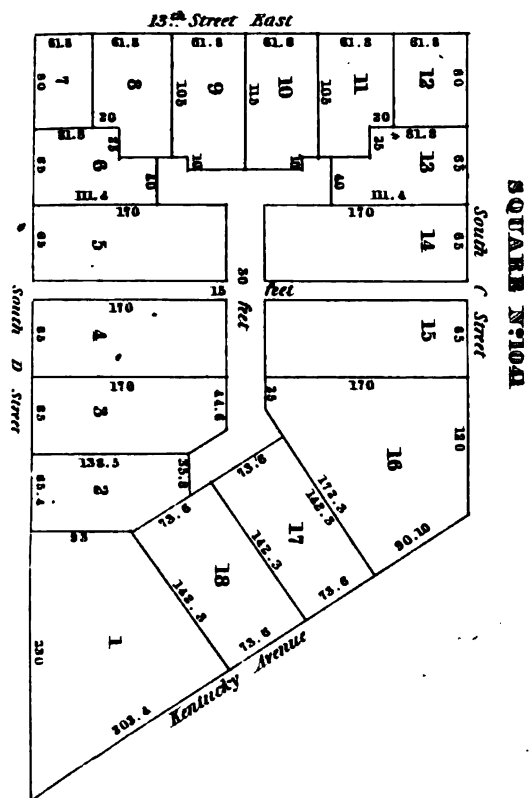





**SQUARE N°1044**

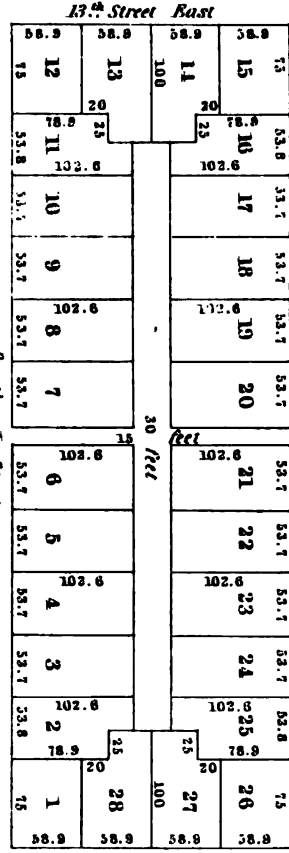
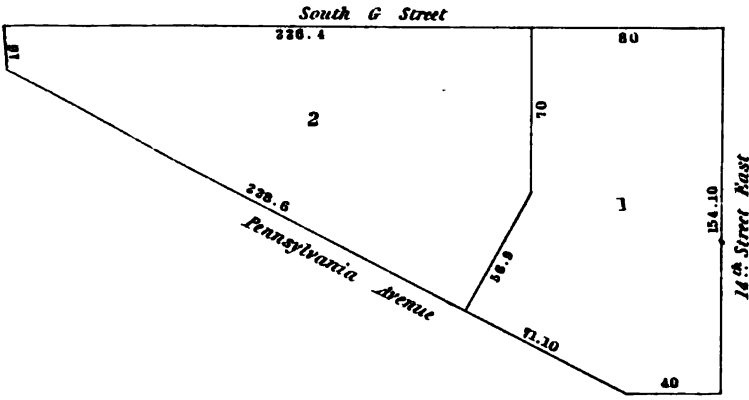

**SQUARE N°1041**

South K Street

**SQUARE N°1045**

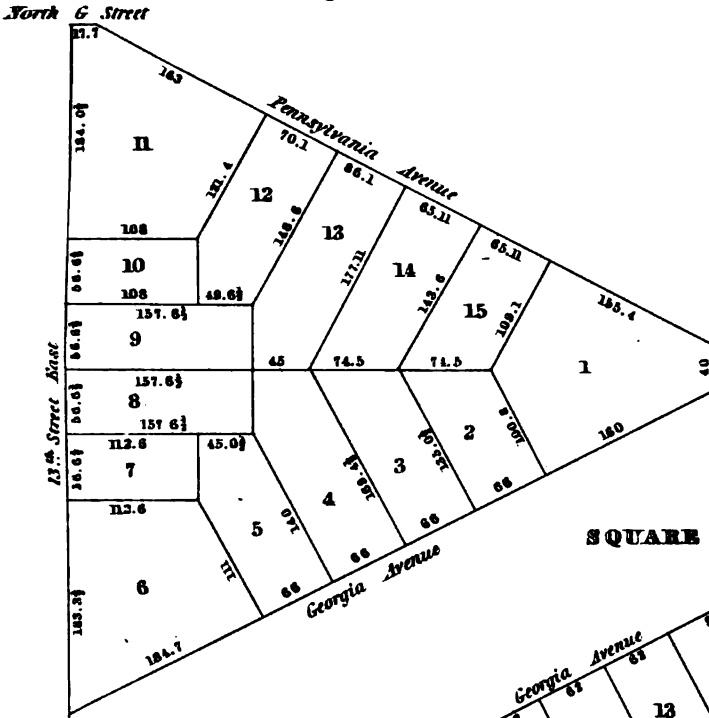

**SQUARE N°1046**

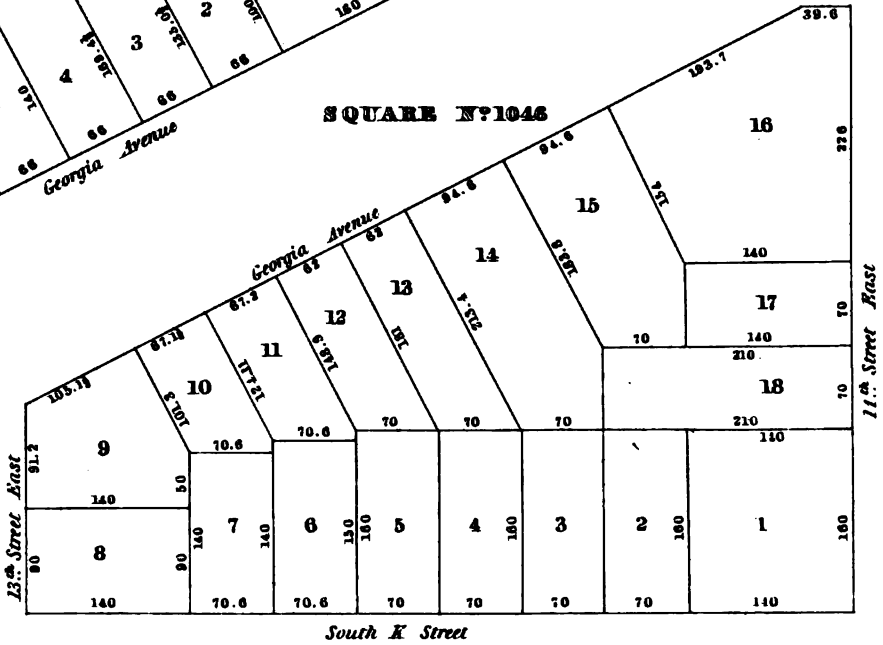

**SQUARE N°1048**

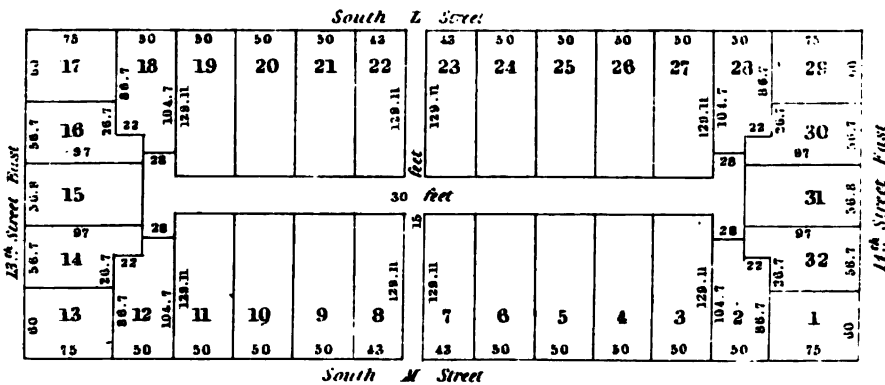



### SQUARE N<sup>o</sup>1049

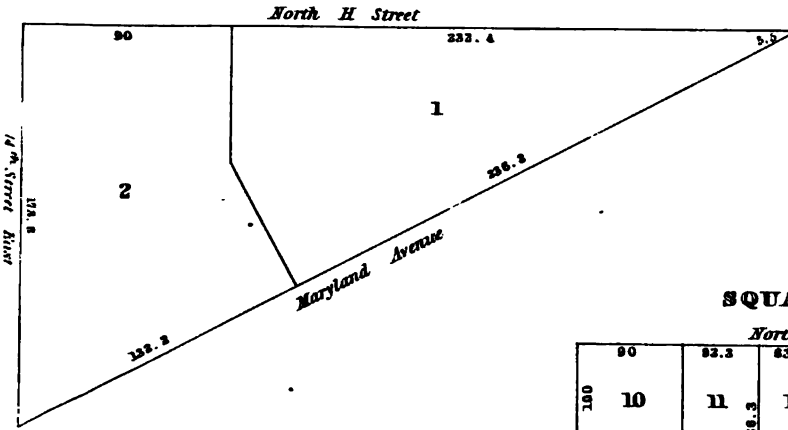

### SQUARE N. OF N<sup>o</sup>1049

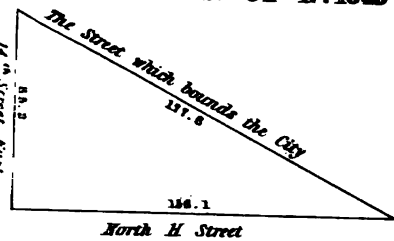

### SQUARE N<sup>o</sup>1051

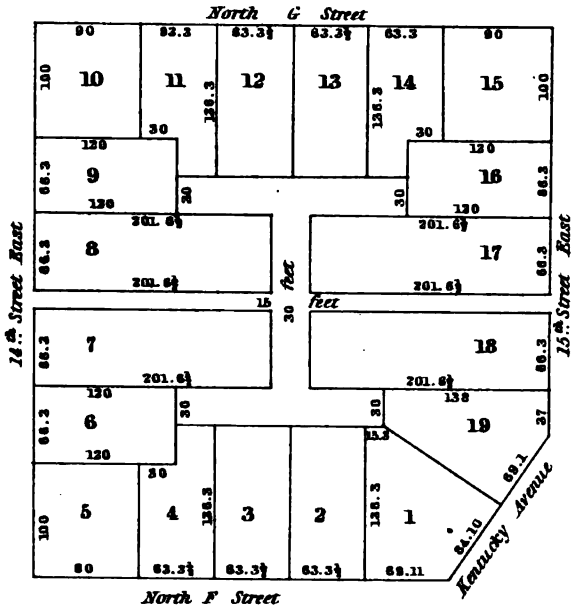

### 14th Street East

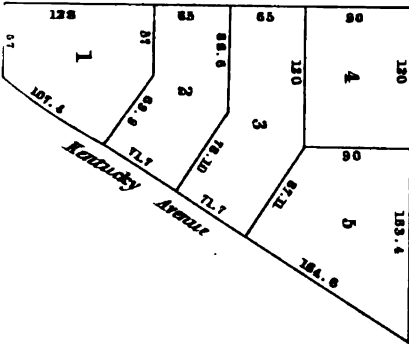

### SQUARE N<sup>o</sup>1055

### SQUARE N<sup>o</sup>1056

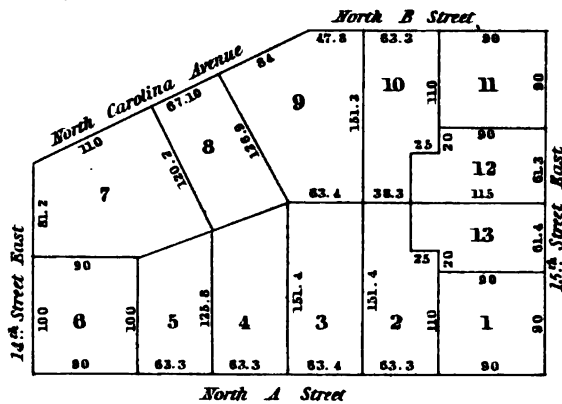

### SQUARE N<sup>o</sup>1054

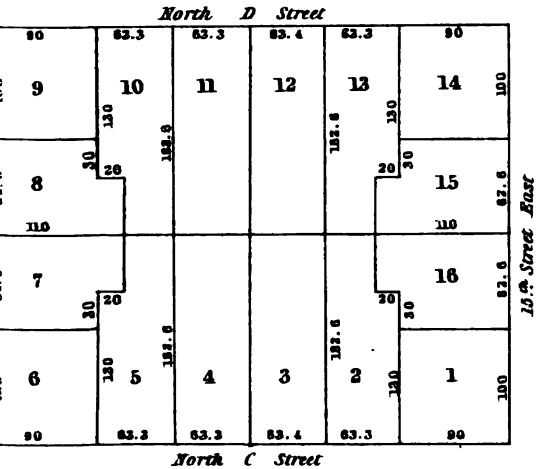

### SQUARE N<sup>o</sup>1053

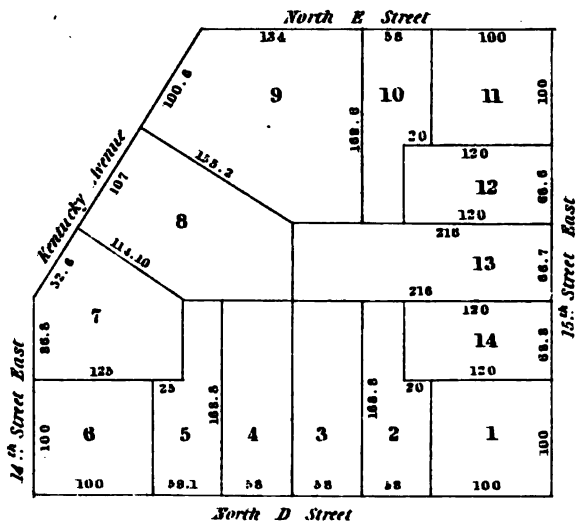

### SQUARE N<sup>o</sup>1050

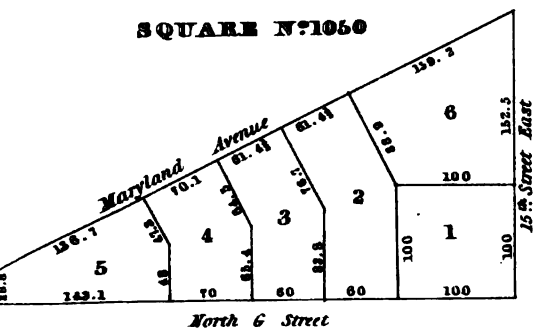



**SQUARE N°1065**

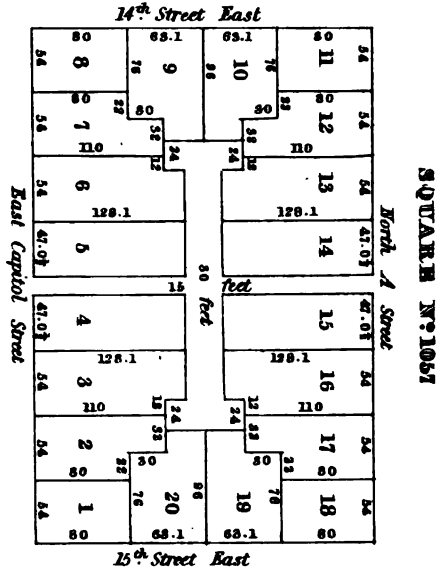
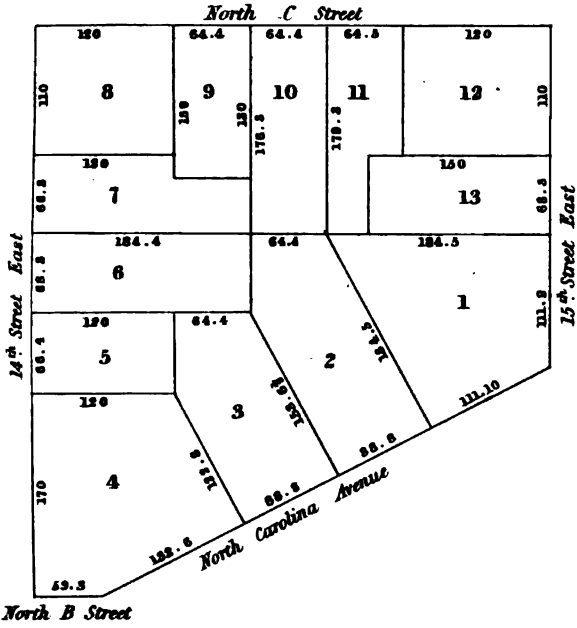

**SQUARE S. OF N°1069**

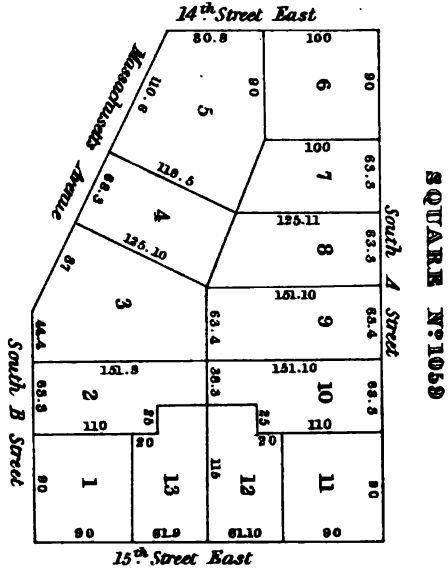
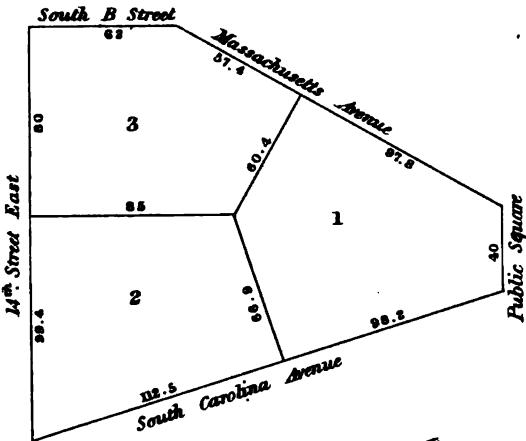

**SQUARE N°1060**

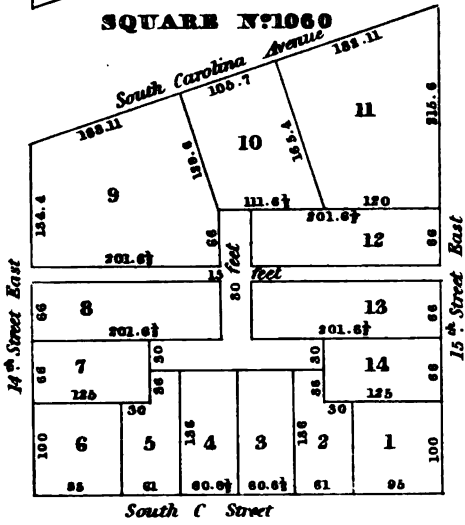

**SQUARE N°1061**

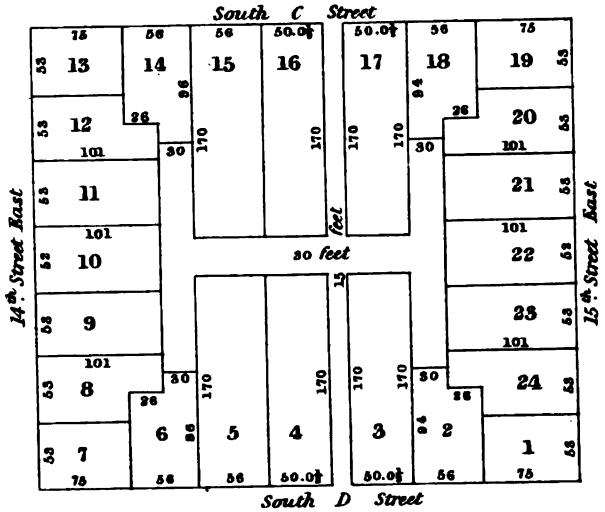

**SQUARE N°1062**

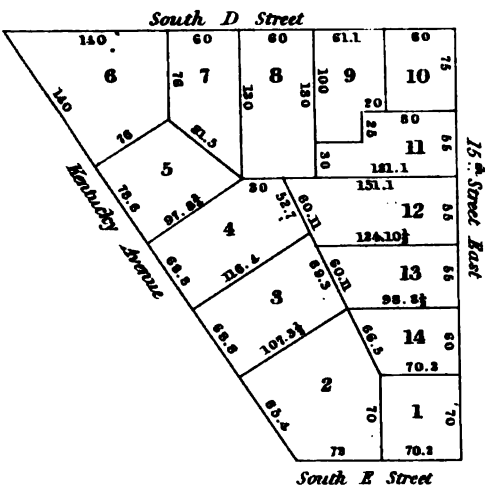

**SQUARE S. OF N°1062**

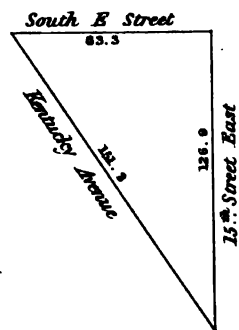

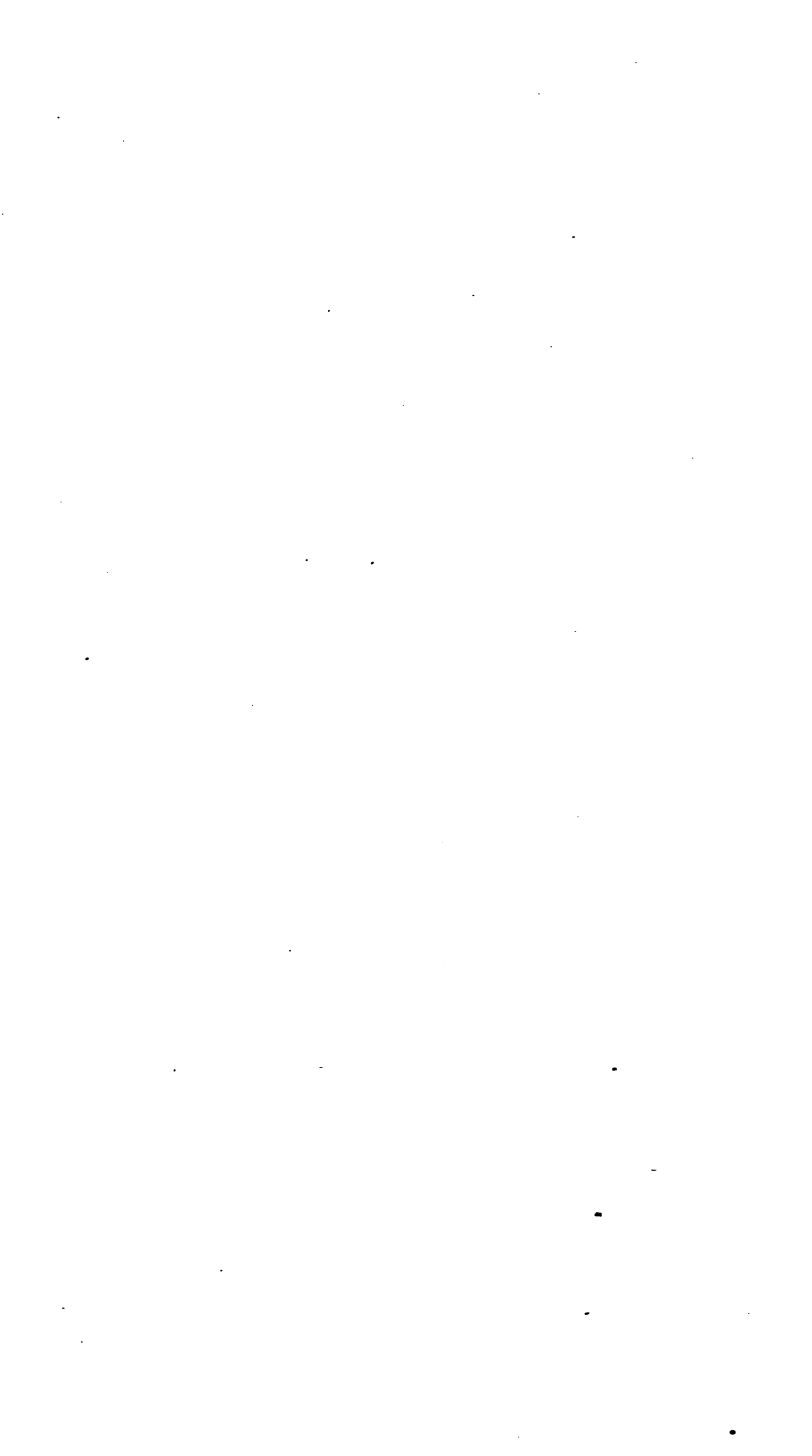

**SQUARE N#1063**

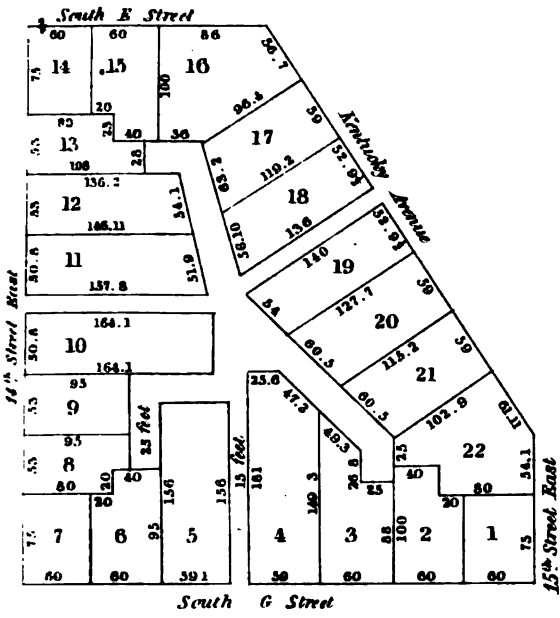

*14th Street East*

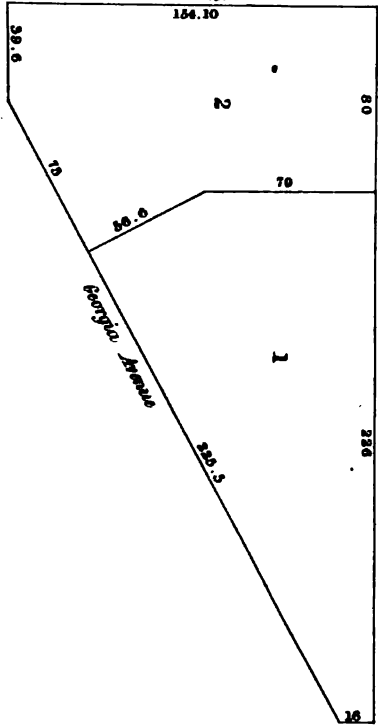

**SQUARE N#1064**

**SQUARE N. E. OF N#1065**

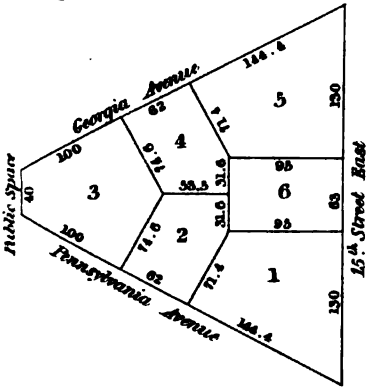

**SQUARE N#1065**

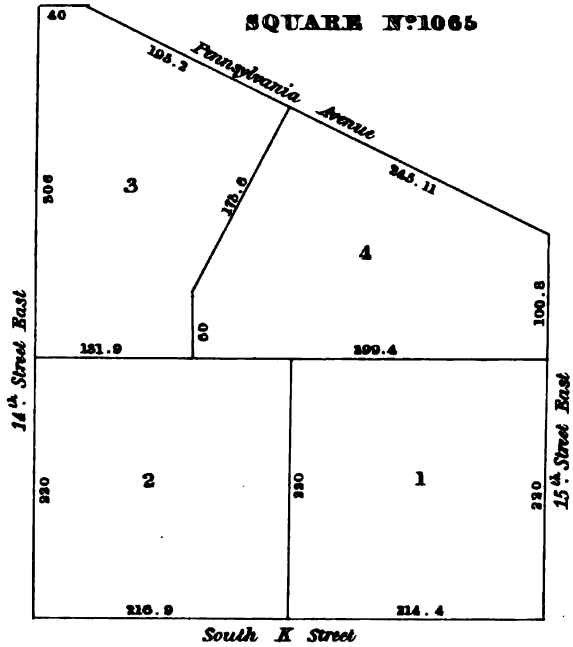

*14th Street East*

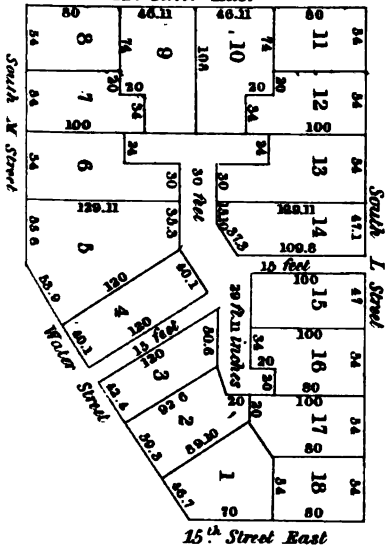

**SQUARE N#1067**

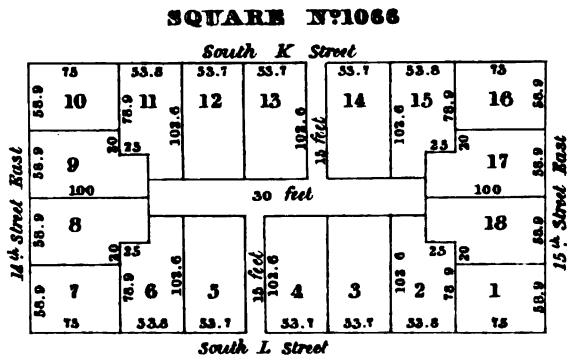

**SQUARE N#1068**

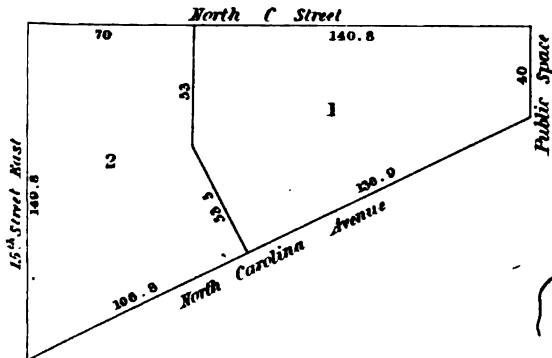

**SQUARE N#1068**

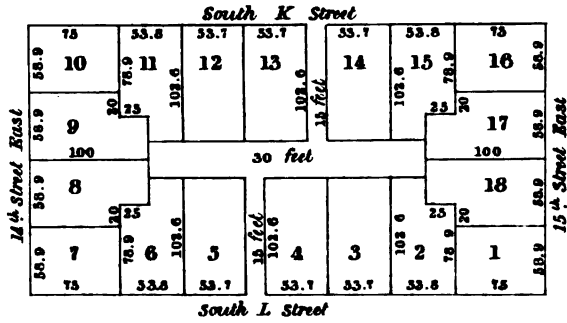

**SQUARE S. OF N#1067**

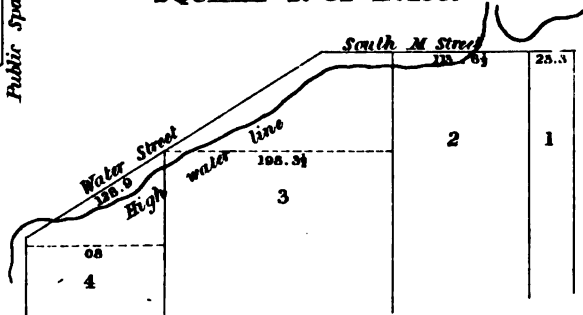





SQUARE S.E. OF N°1068

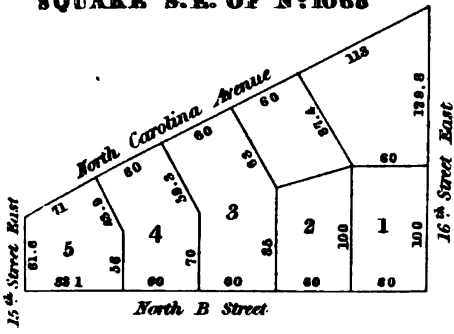

SQUARE N°1069

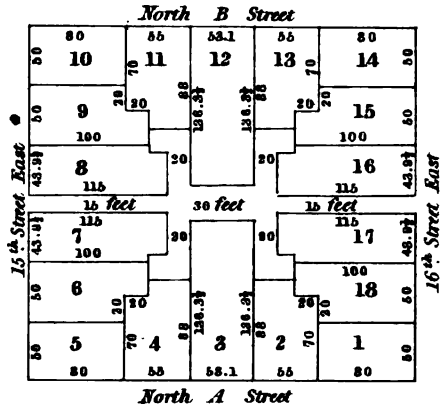

SQUARE N°1071

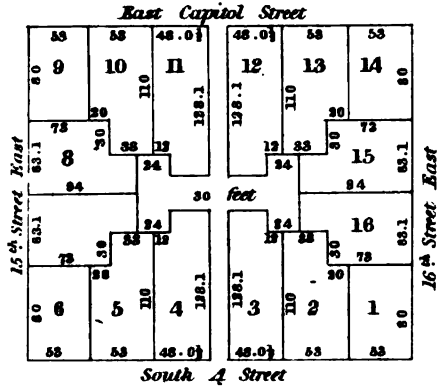

SQUARE N°1072

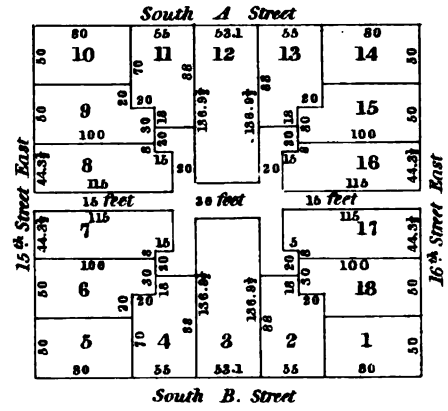

SQUARE S. OF N°1072

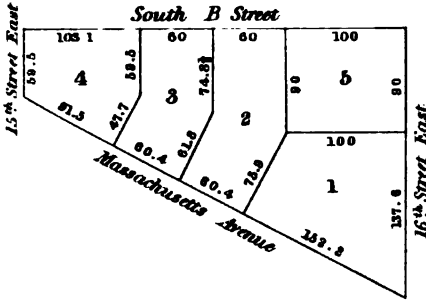

SQUARE N°1074

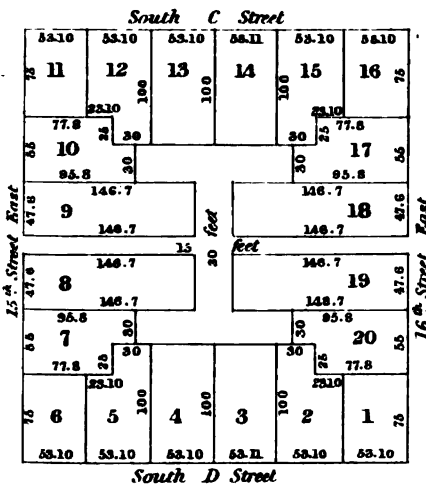

SQUARE N°1073

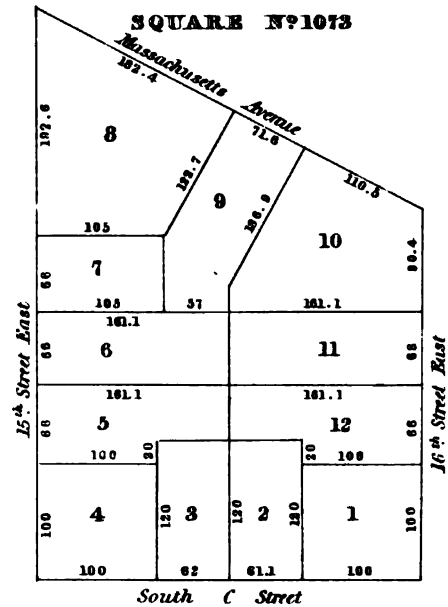

SQUARE N°1075

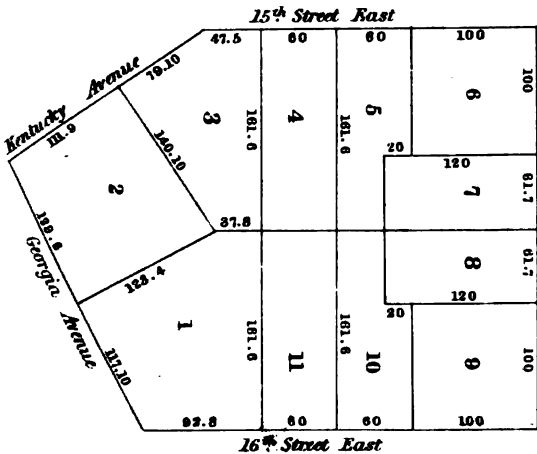
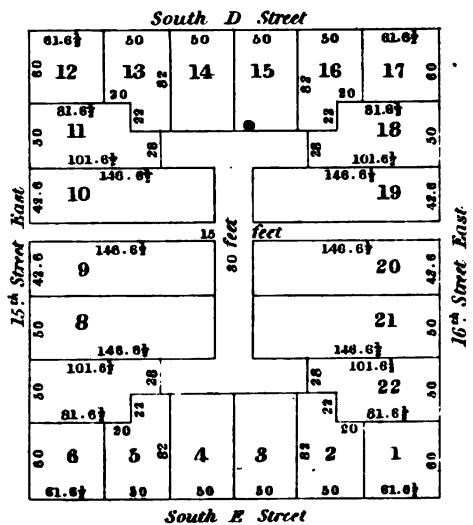

SQUARE N°1076

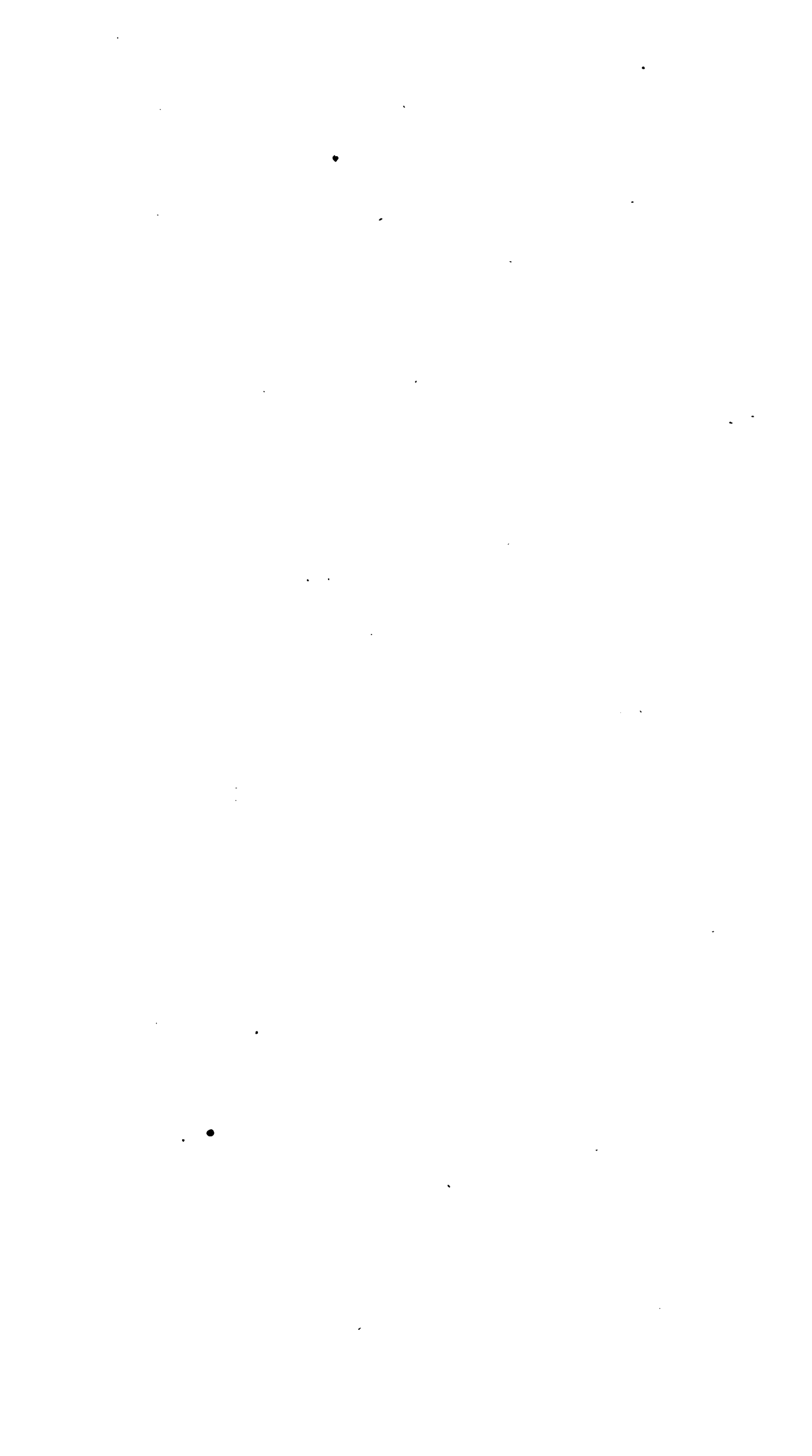

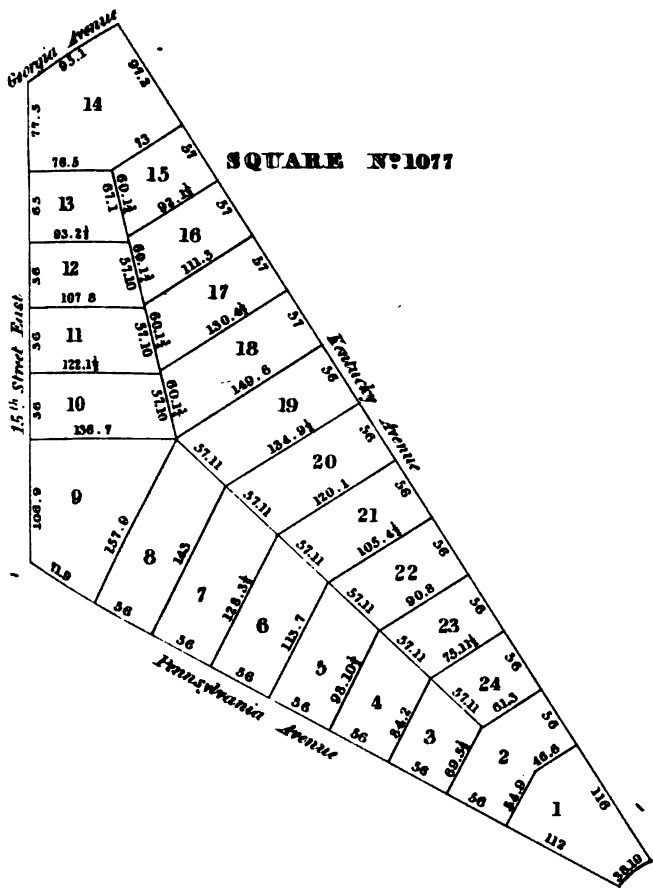

**SQUARE S. OF N°1080**

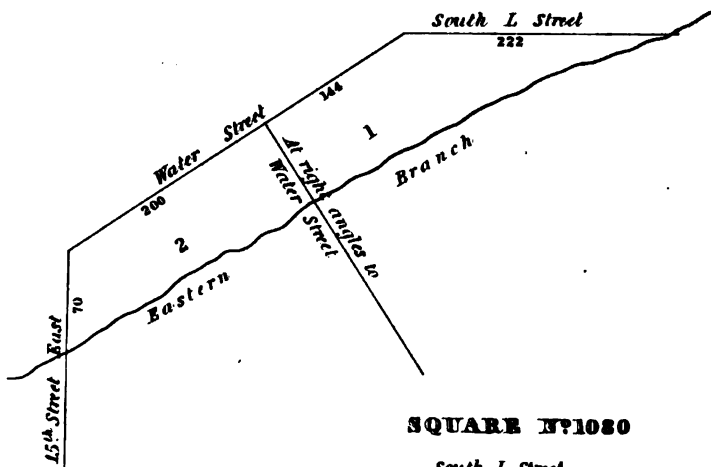

**SQUARE N°1080**

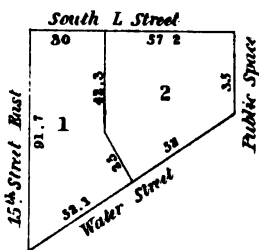

**SQUARE N°1082**

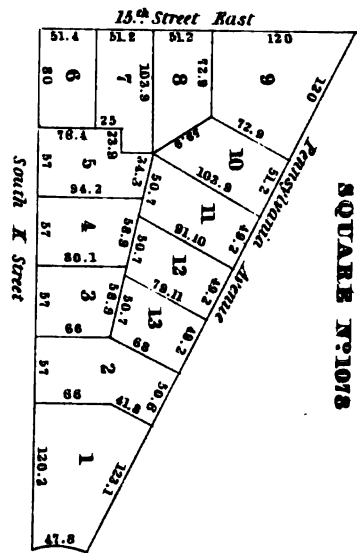
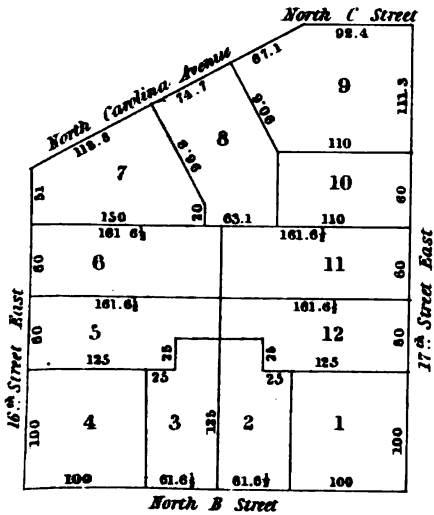

**SQUARE N°1078**

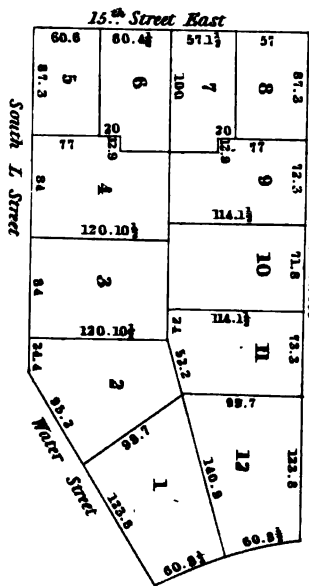

**SQUARE N°1079**

**SQUARE S.E. OF N°1078**

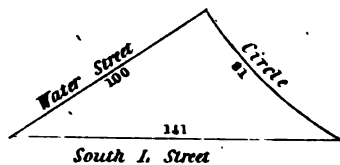

**SQUARE N°1083**

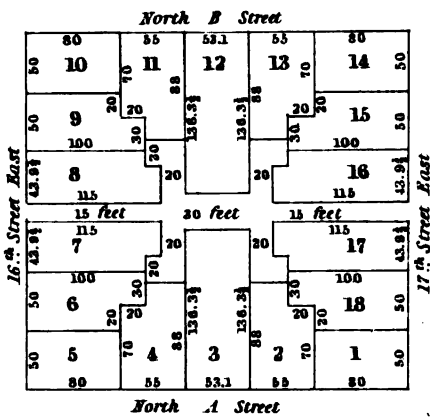



SQUARE N°1085

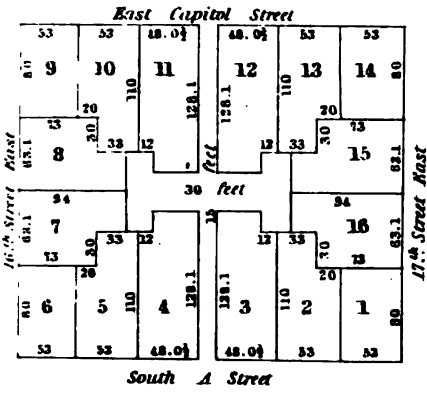

SQUARE N°1086

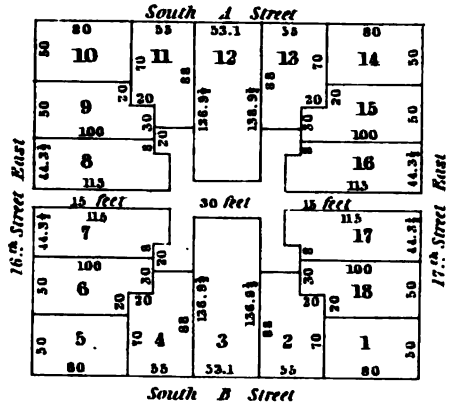

SQUARE N°1087

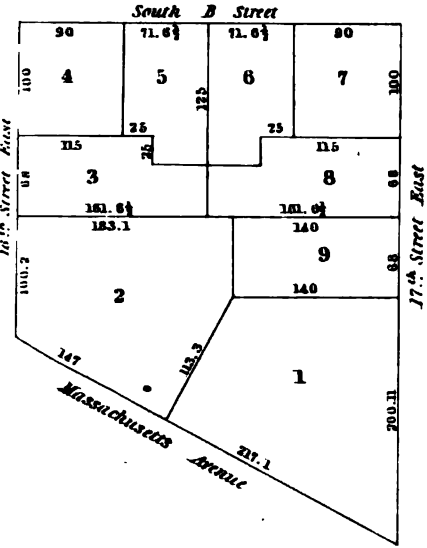

SQUARE N°1088

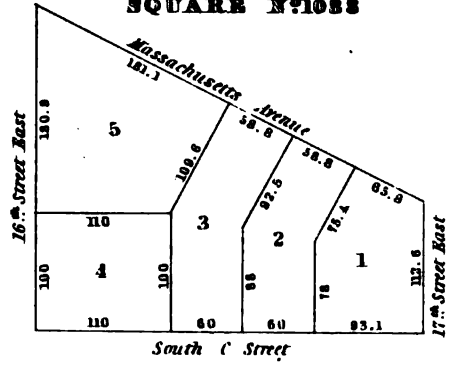

SQUARE N°1089

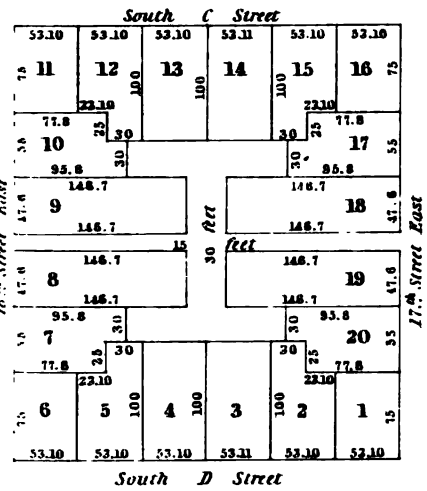

SQUARE N°1090

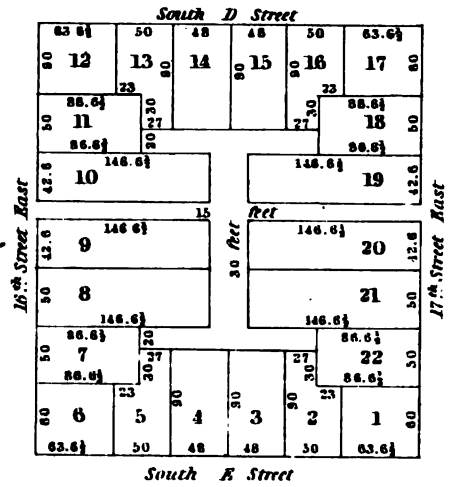

SQUARE N°1091

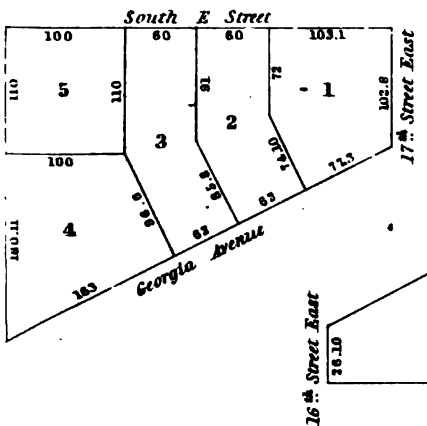

SQUARE S. OF N°1091

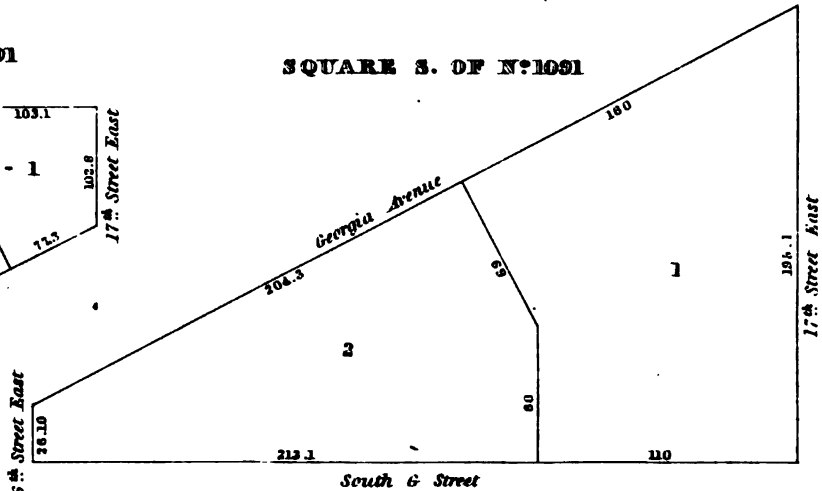



**SQUARE N°1092**

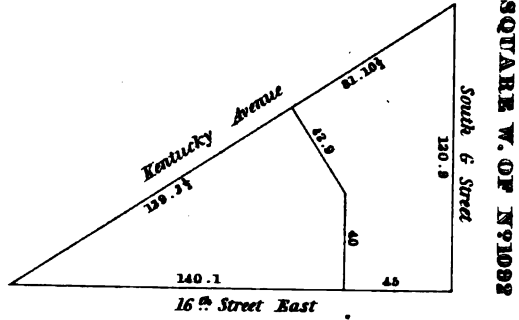
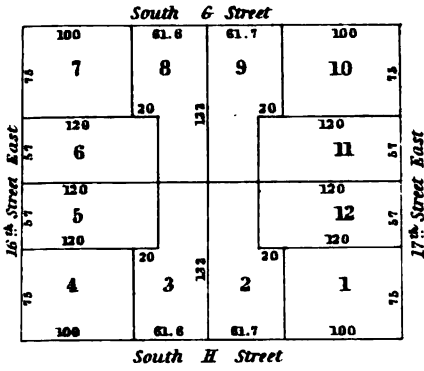

**SQUARE N°1093**

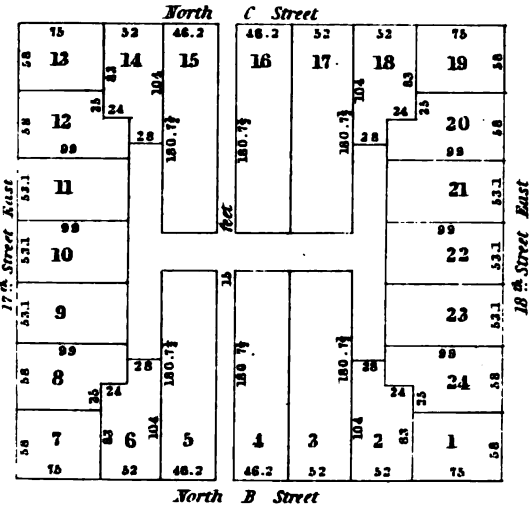

**SQUARE N°1094**

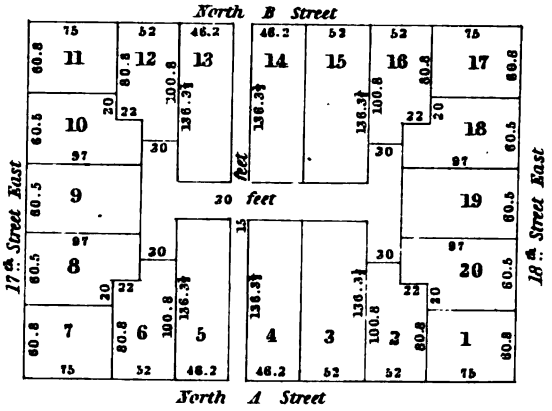

**SQUARE N°1095**

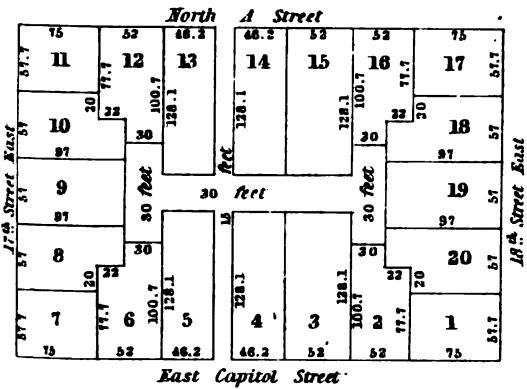

**SQUARE N°1096**

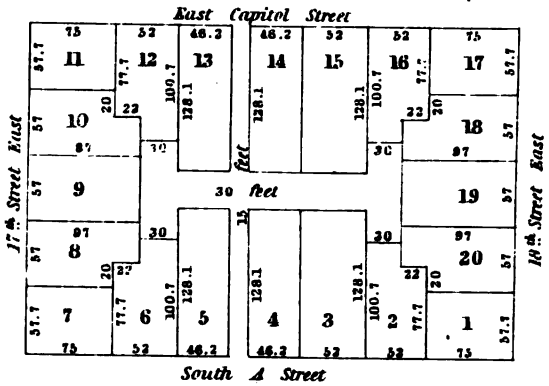

**SQUARE N°1097**

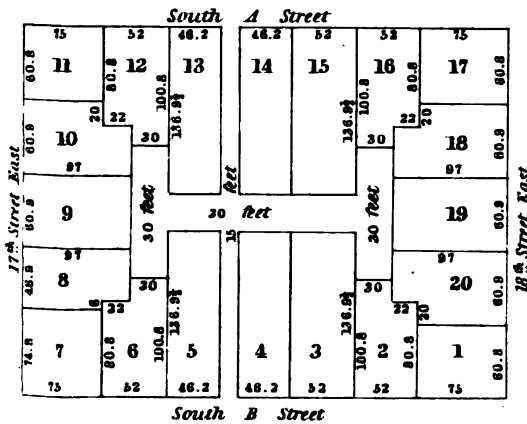

**SQUARE N°1100**

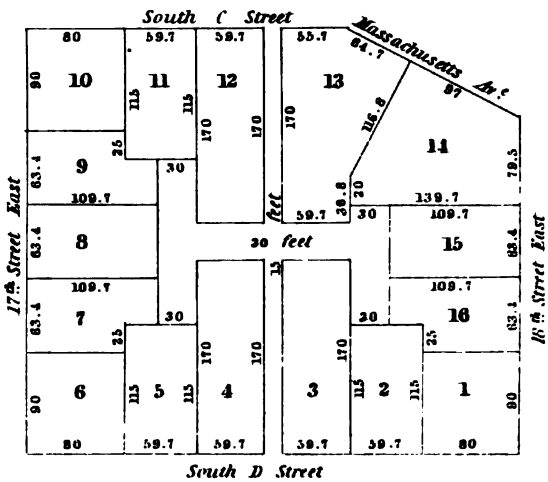





SQUARE N°1103

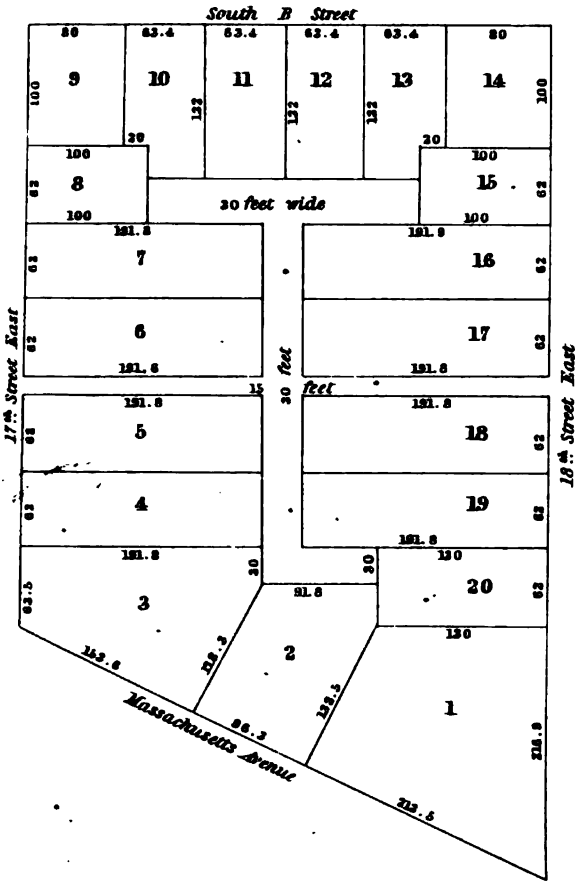

SQUARE N°1104

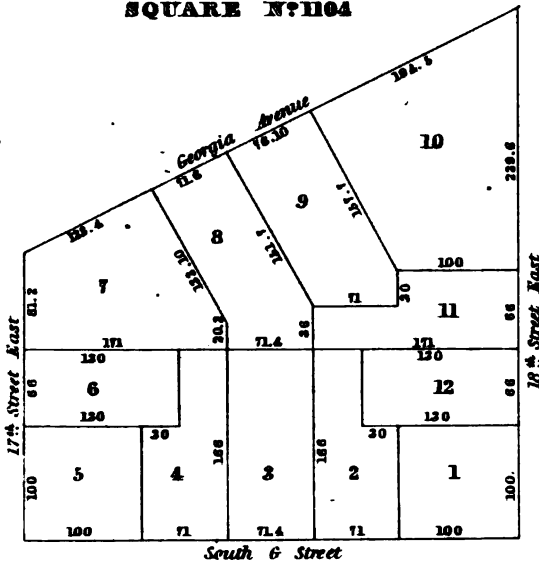

SQUARE N°1105

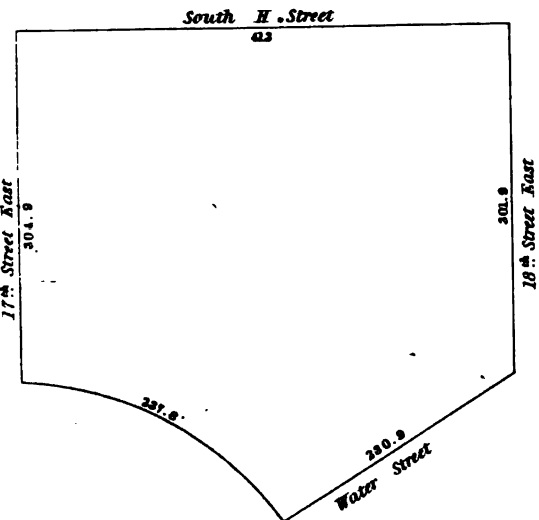

SQUARE N°1106

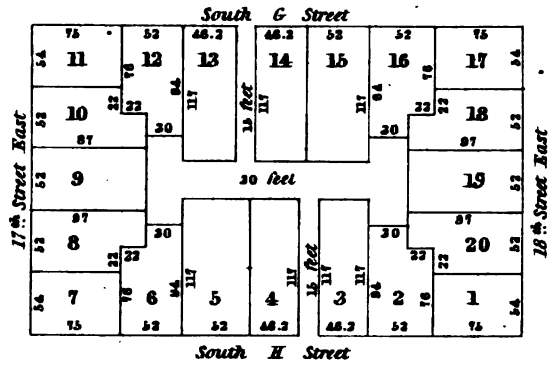

SQUARE N°1107

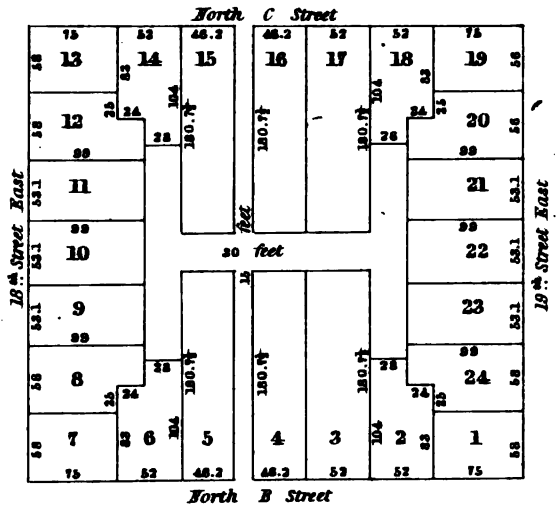

SQUARE N°1108

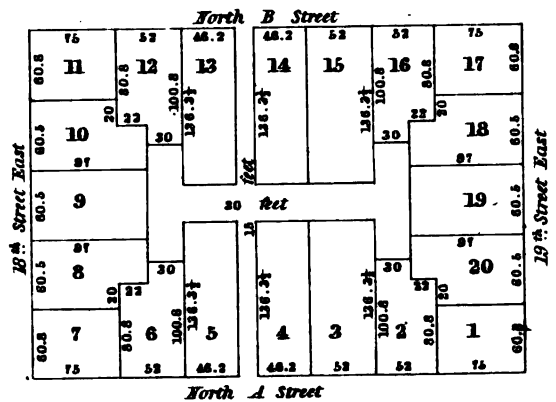

SQUARE N°1102

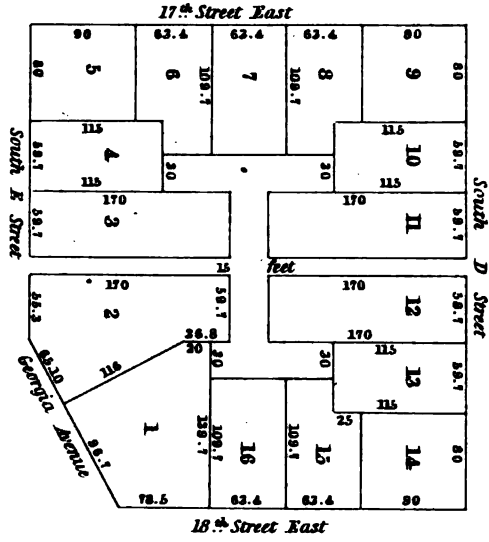



**SQUARE N°1109**

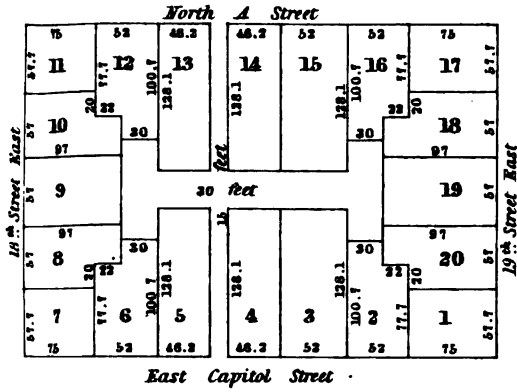

**SQUARE N°1110**

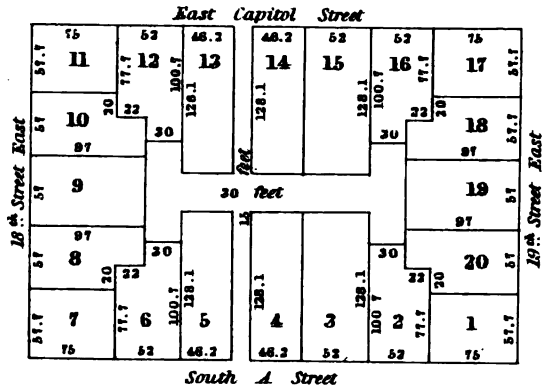

**SQUARE N°1111**

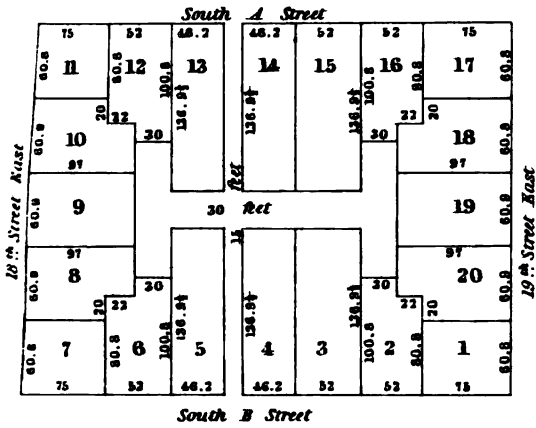

**SQUARE N°1112**

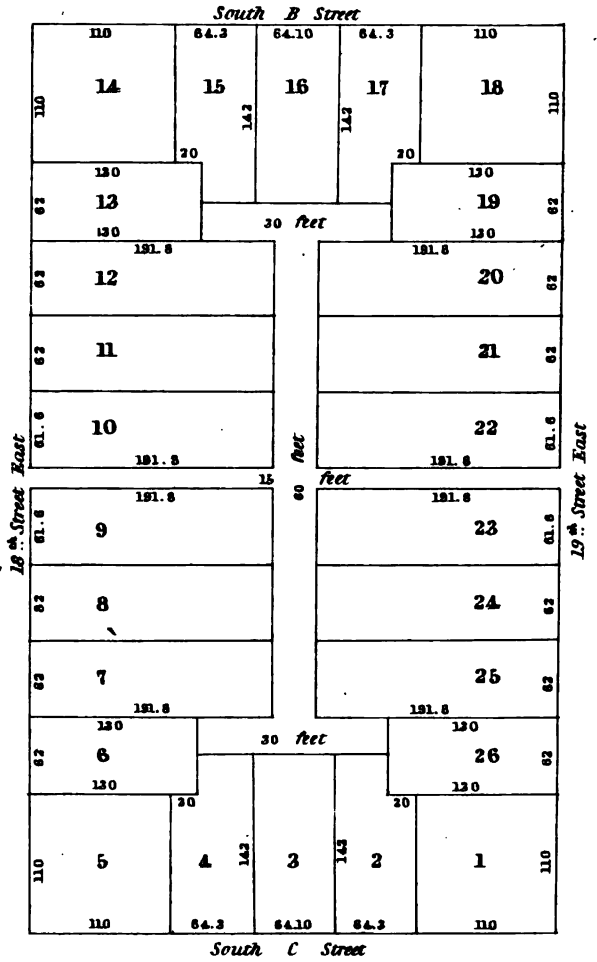

**SQUARE N°1113**

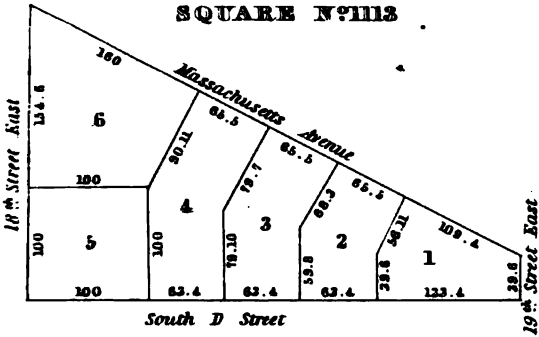

**SQUARE S.E. OF N°1114**

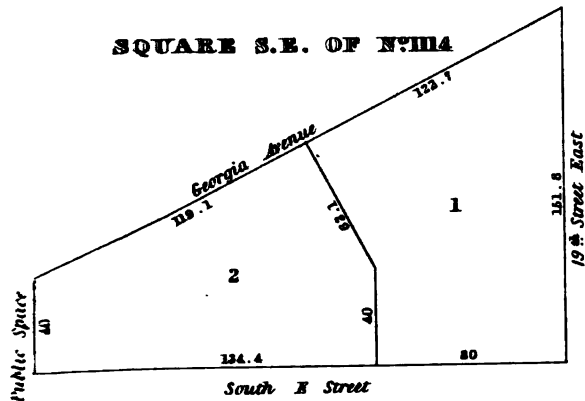

**SQUARE N°1114**

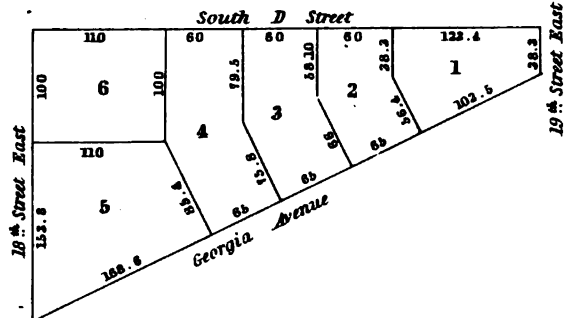

**SQUARE N°1116**

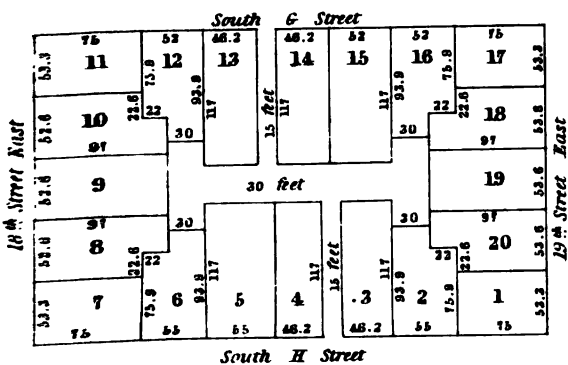

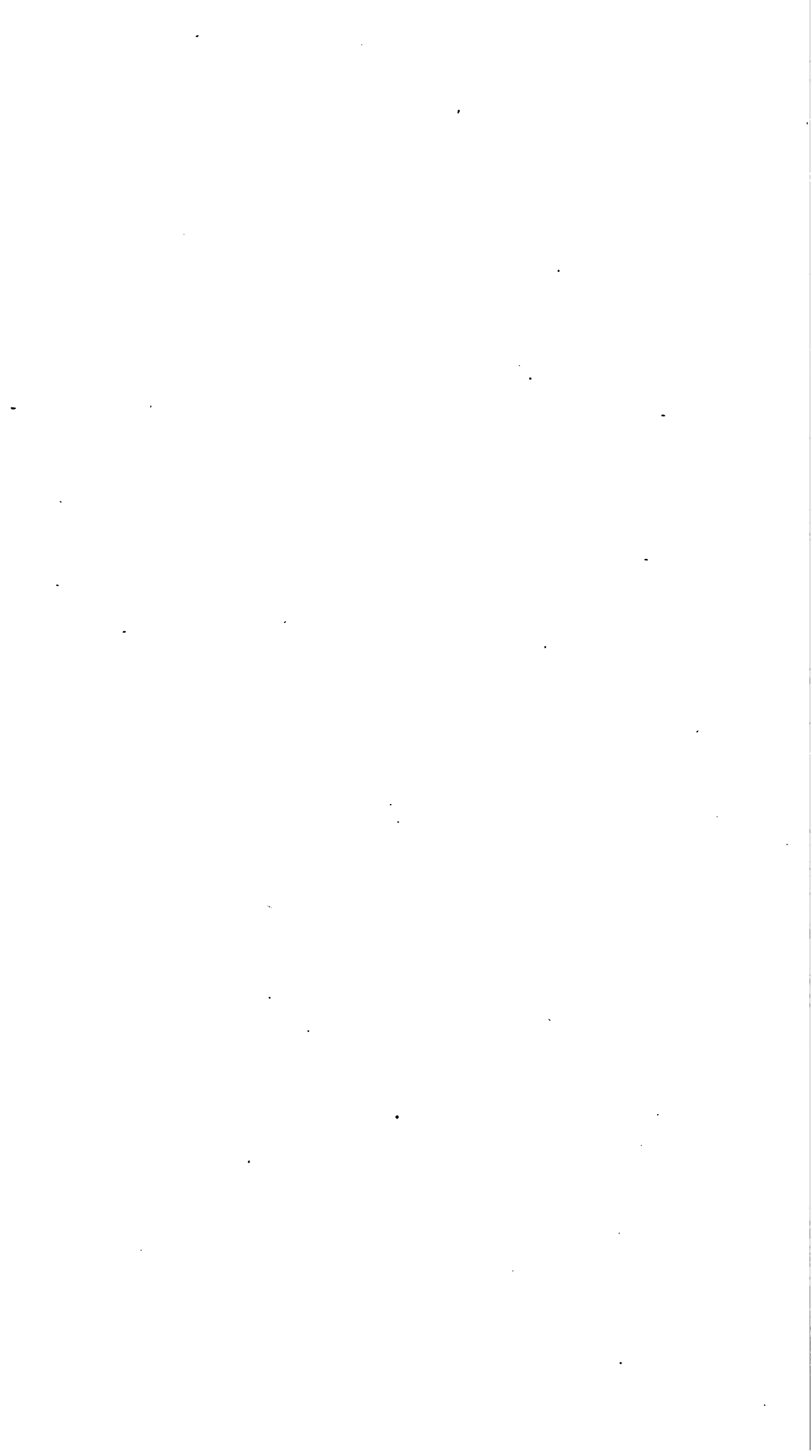

**SQUARE N°1116**

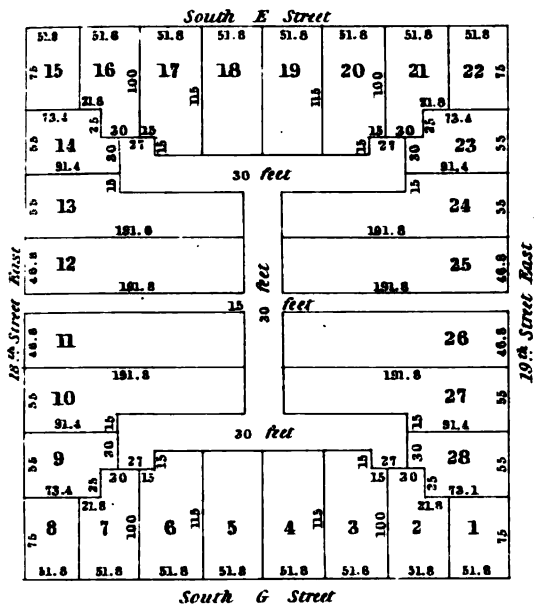

**SQUARE N°1117**

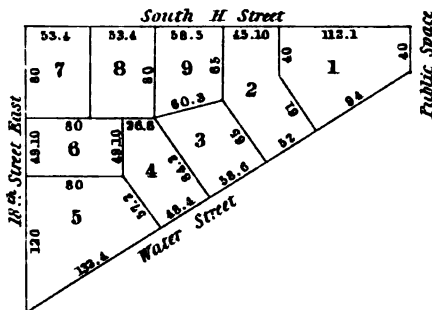

**SQUARE N°1118**

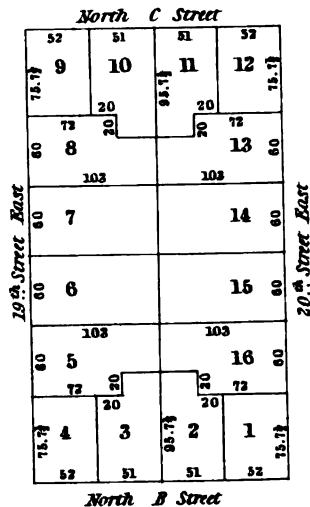

**SQUARE N°1119**

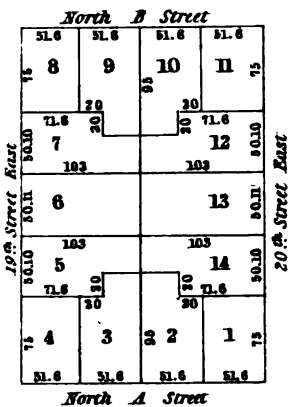

**SQUARE N°1120**

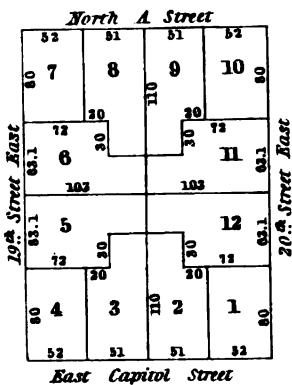

**SQUARE N°1123**

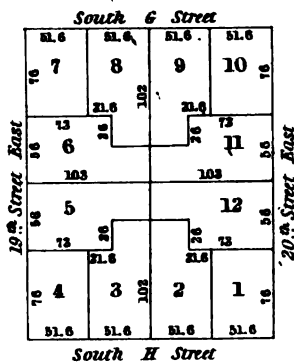

**SQUARE N°1121**

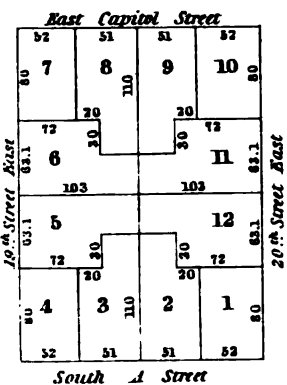

**SQUARE N°1122**

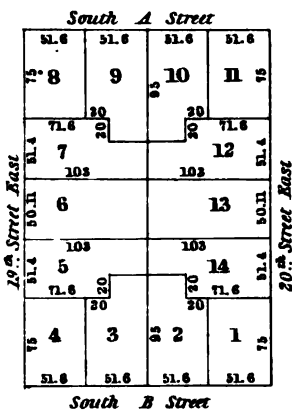

**SQUARE N°1126**

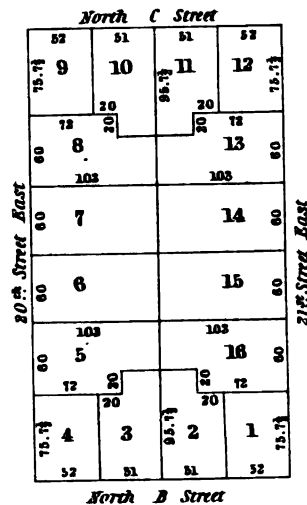

**SQUARE N°1127**

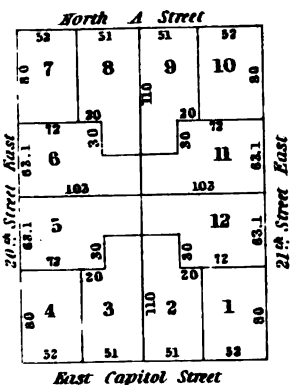

**SQUARE N°1128**

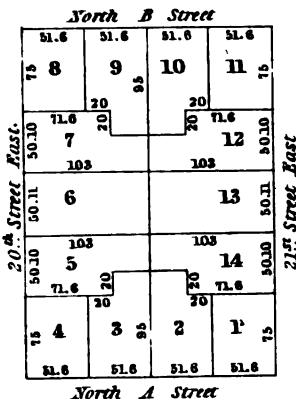



SQUARE N<sup>o</sup>1128

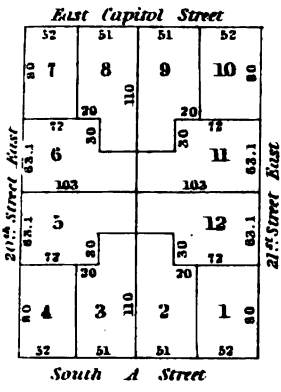

SQUARE N<sup>o</sup>1129

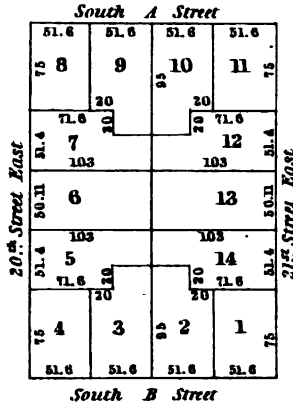

SQUARE N<sup>o</sup>1132

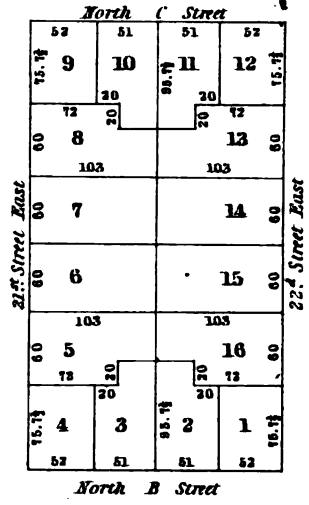

SQUARE N<sup>o</sup>1133

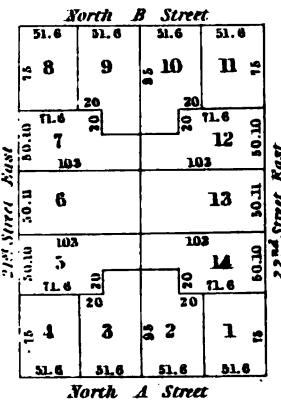

SQUARE N<sup>o</sup>1134

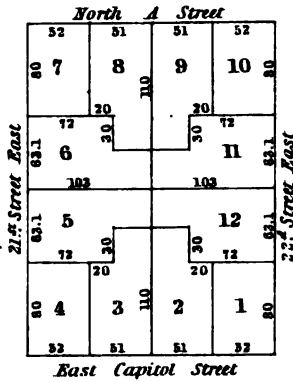

SQUARE N<sup>o</sup>1135

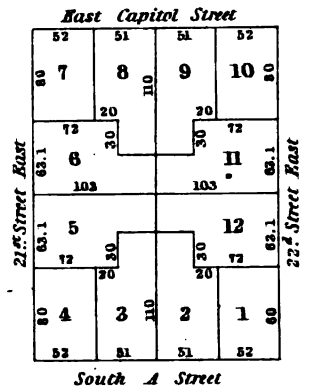

SQUARE N<sup>o</sup>1137

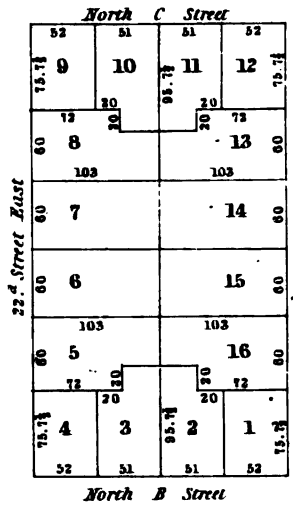

SQUARE N<sup>o</sup>1136

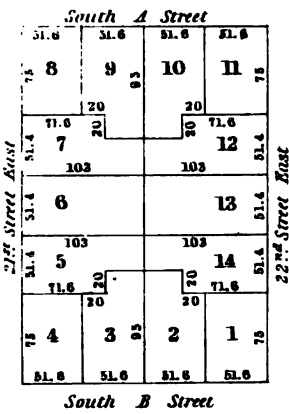

SQUARE N<sup>o</sup>1138

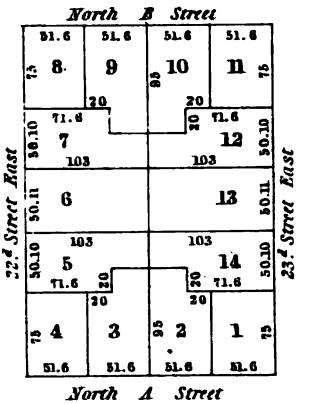

SQUARE N<sup>o</sup>1139

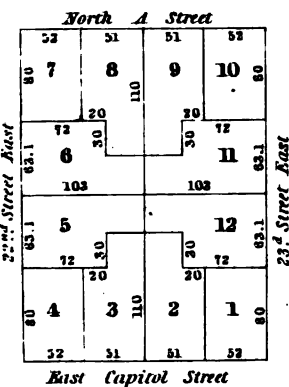

SQUARE N<sup>o</sup>1140

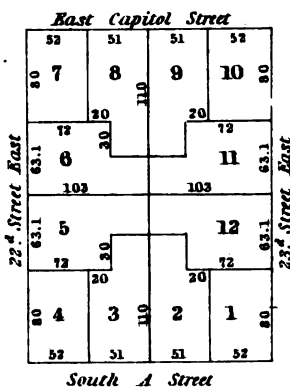

SQUARE S. OF N<sup>o</sup>1140

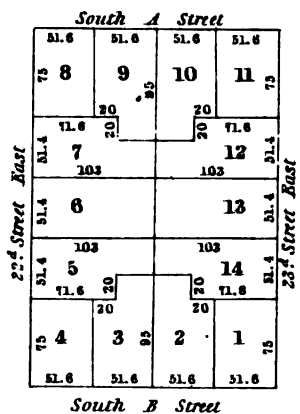





**SQUARE N°1141**

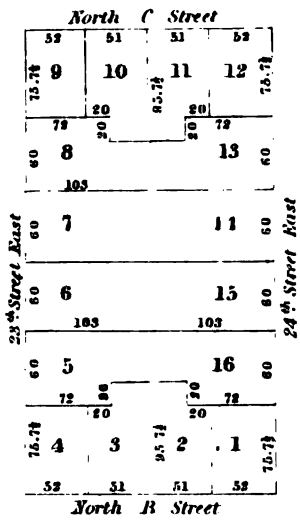

**SQUARE N°1142**

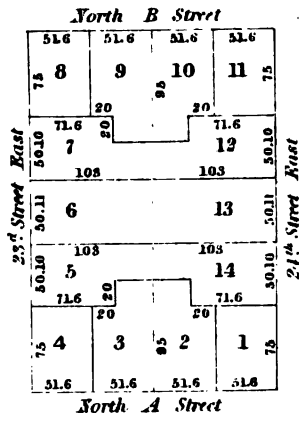

**SQUARE N°1143**

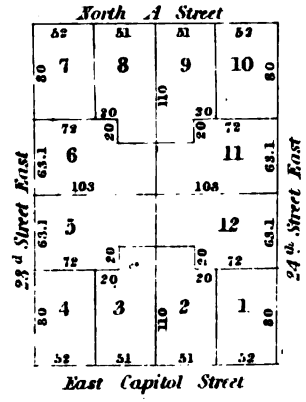

2294-5

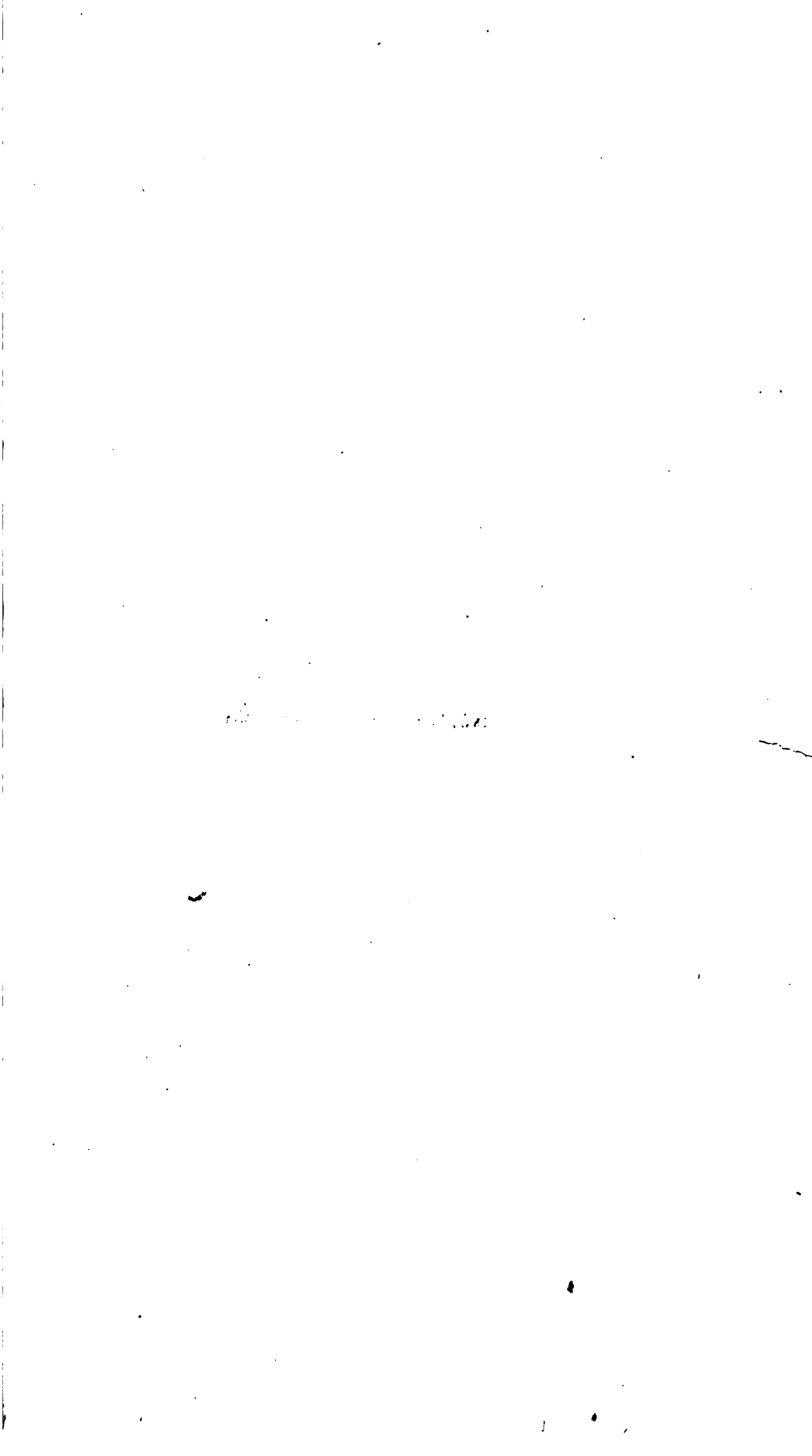

City Planning  
Room

DATE DUE

NOT TO BE TAKEN FROM LIBRARY

DEMCO 38-297

NOT TO BE TAKEN FROM LIBRARY

\*  
NAC  
282  
Wash  
1852

U.S. Congress. House.

Maps of the District of

Columbia and plats of the squares  
and lots of the City of Washington

DATE

ISSUED TO

8140

3 pieces in pocket

JAN

7 1981

repair

U.S.

8140

3 pieces in pocket →

NOT TO BE TAKEN FROM LIBRARY

oversize  
NAC 282 Wash 1852  
Maps of the District of  
Loeb Design Library



3 2044 027



